

[54] SUBMARINE

[75] Inventor: **Richard T. Robinson**, Los Angeles,  
Calif.

[73] Assignee: **August G. Carloni**, Los Angeles,  
Calif.

[\*\*] Term: **14 Years**

[21] Appl. No.: **918,285**

[22] Filed: **Jun. 22, 1978**

[51] Int. Cl. .... **D12-06**

[52] U.S. Cl. .... **D12/308**

[58] Field of Search ..... **D12/65, 72; 46/94;  
114/312**

[56]

**References Cited**

**U.S. PATENT DOCUMENTS**

D. 200,183	1/1965	Ordway .....	D12/72
D. 200,941	4/1965	Fiedler .....	D12/65
D. 219,182	11/1970	Poutout .....	D12/65
2,849,978	9/1958	Durham .....	D12/65

*Primary Examiner*—Sam Rosen

*Attorney, Agent, or Firm*—Ralph B. Pastoriza

[57]

**CLAIM**

The ornamental design for a submarine, substantially as shown.

**DESCRIPTION**

FIG. 1 is a perspective view of a submarine showing my new design;

FIG. 2 is a side elevational view thereof;

FIG. 3 is a front elevational view thereof;

FIG. 4 is a rear elevational view thereof;

FIG. 5 is a top plan view thereof; and,

FIG. 6 is a bottom plan view thereof.

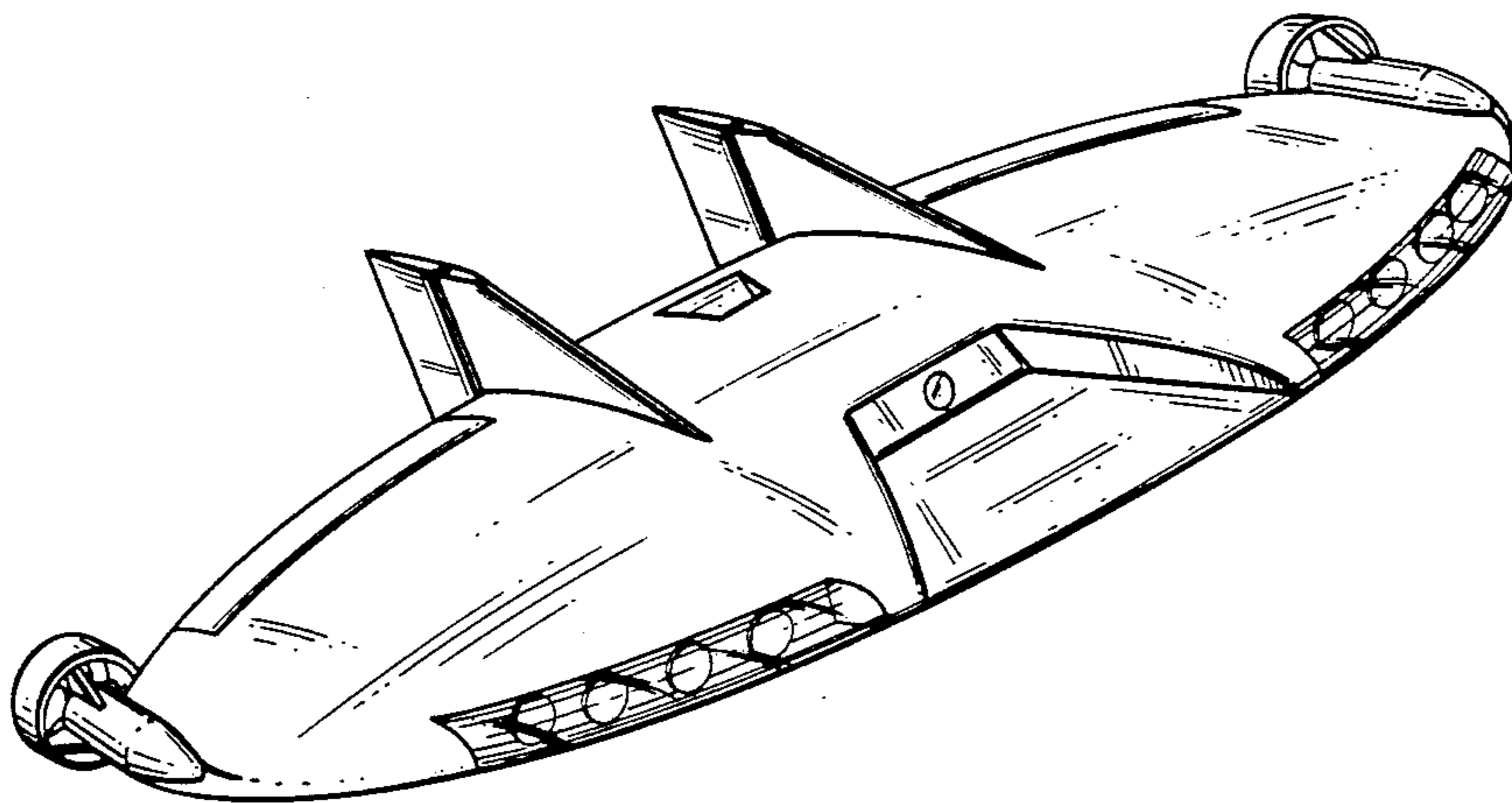

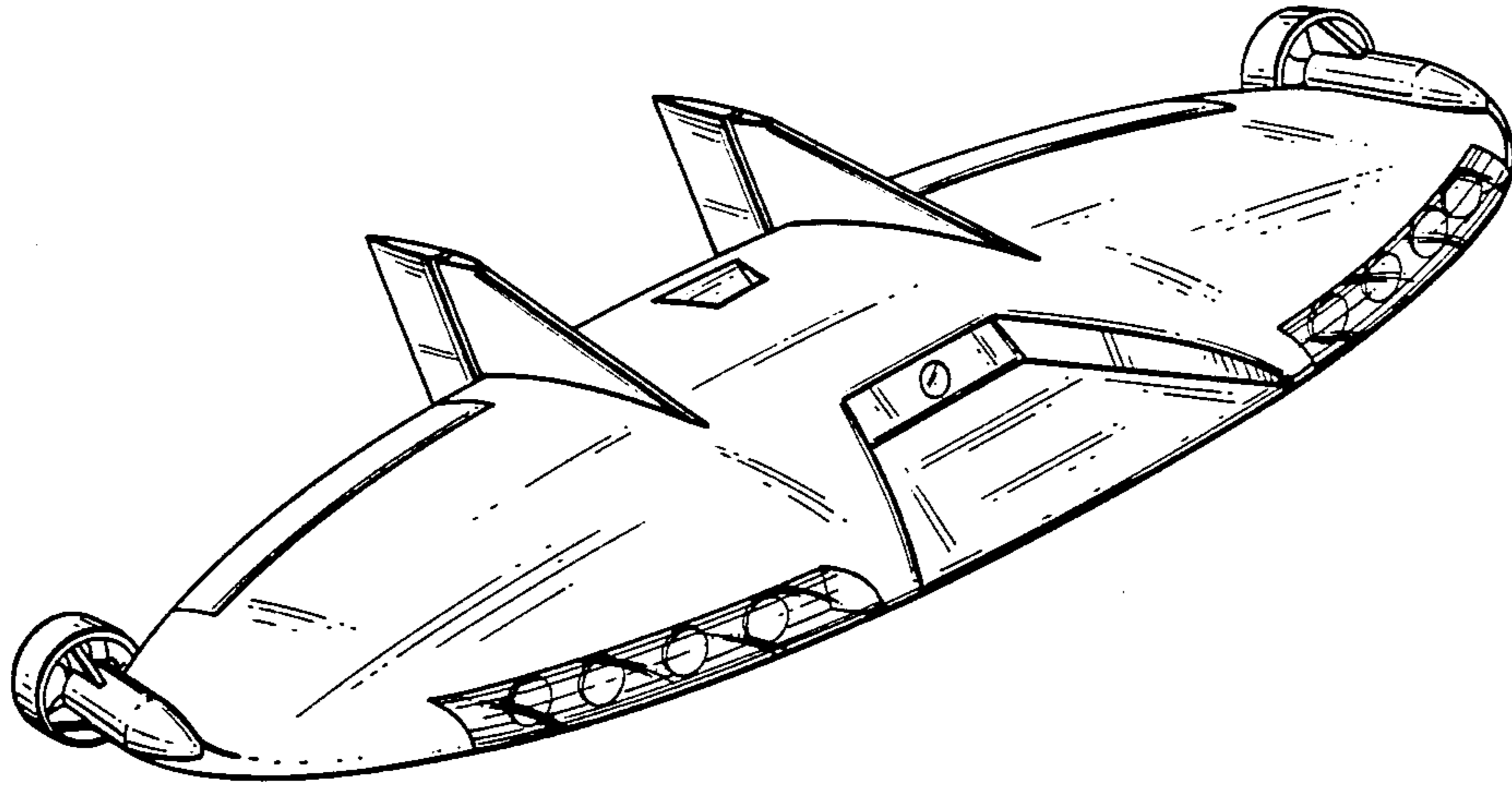

FIG.1

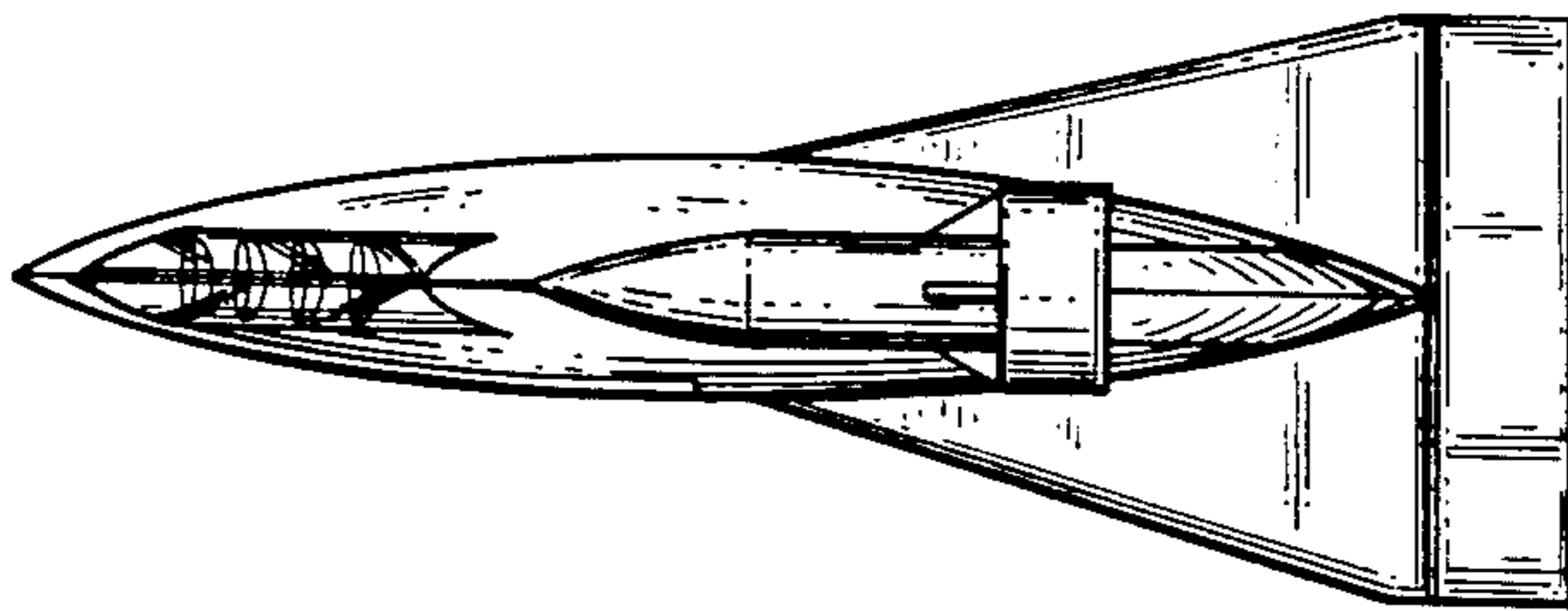

FIG.2

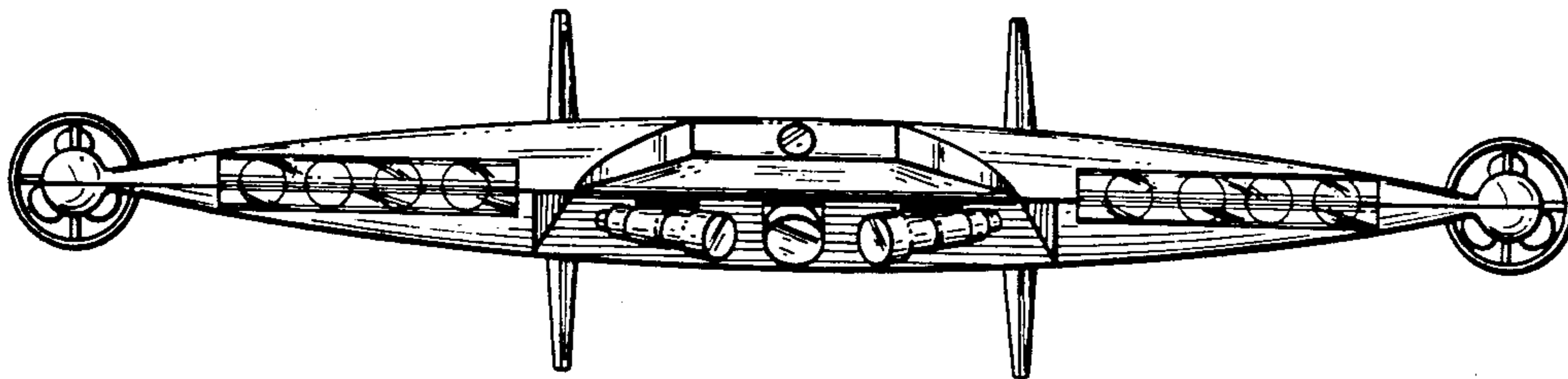

FIG.3

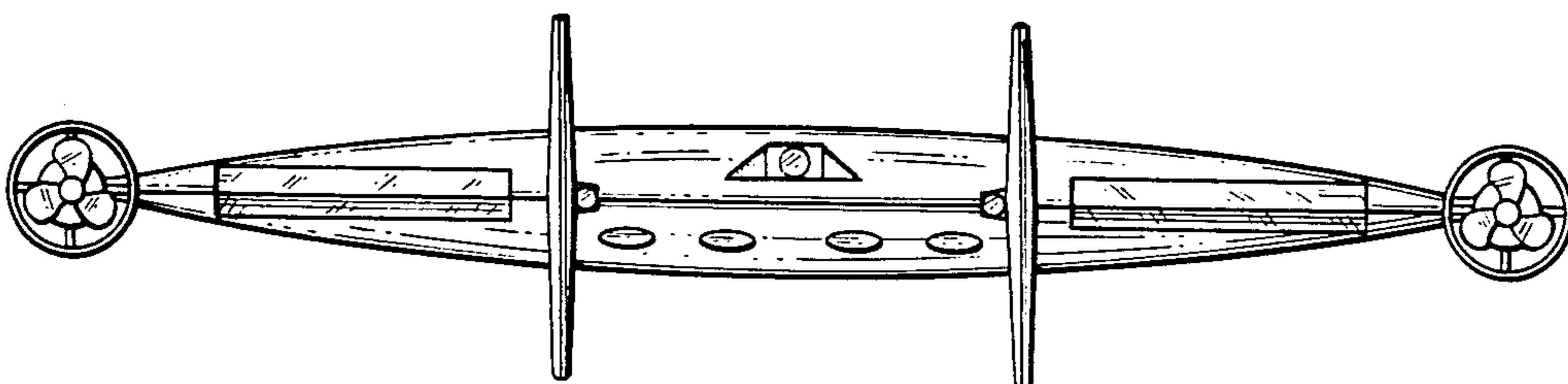

FIG.4

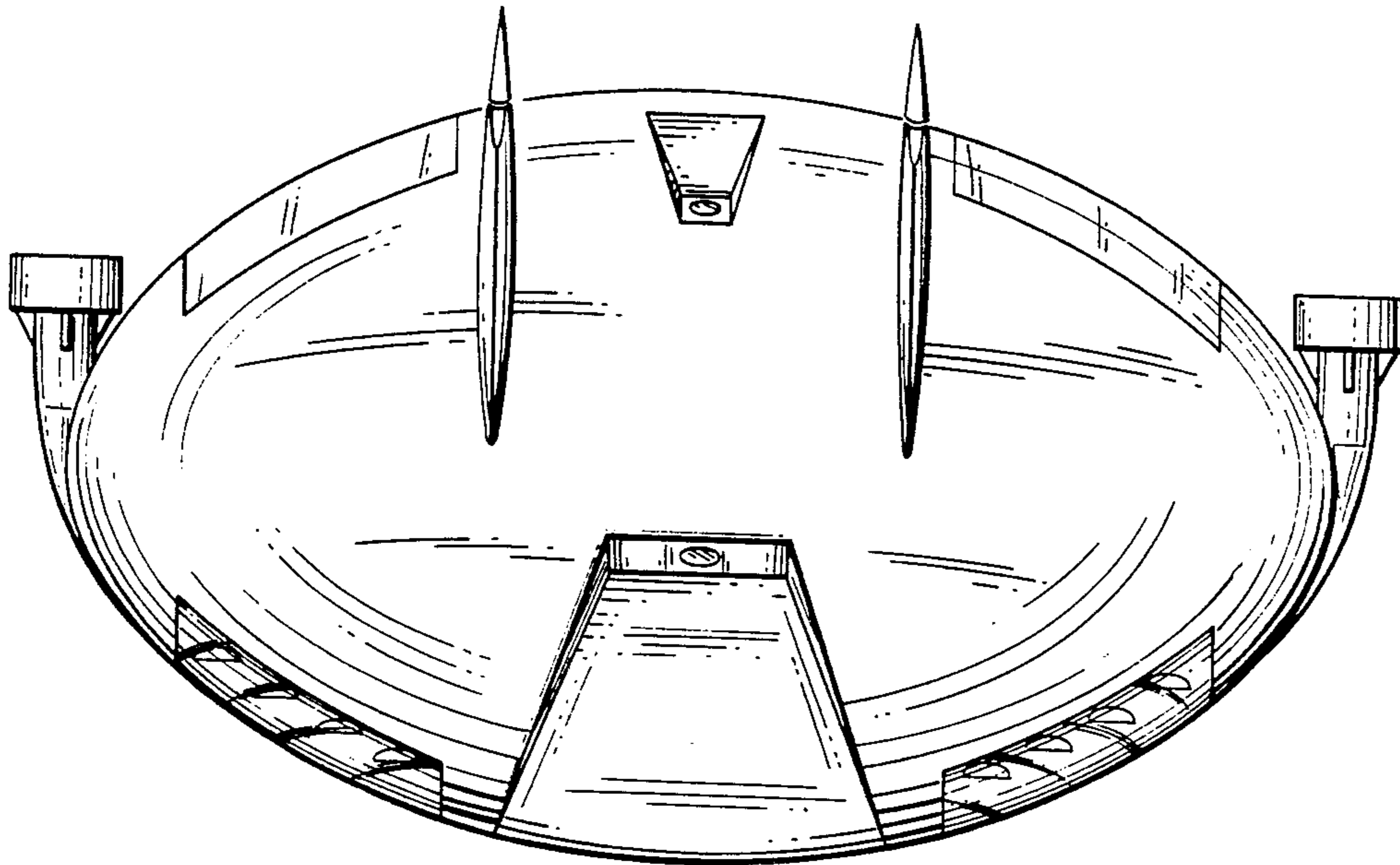

FIG. 5

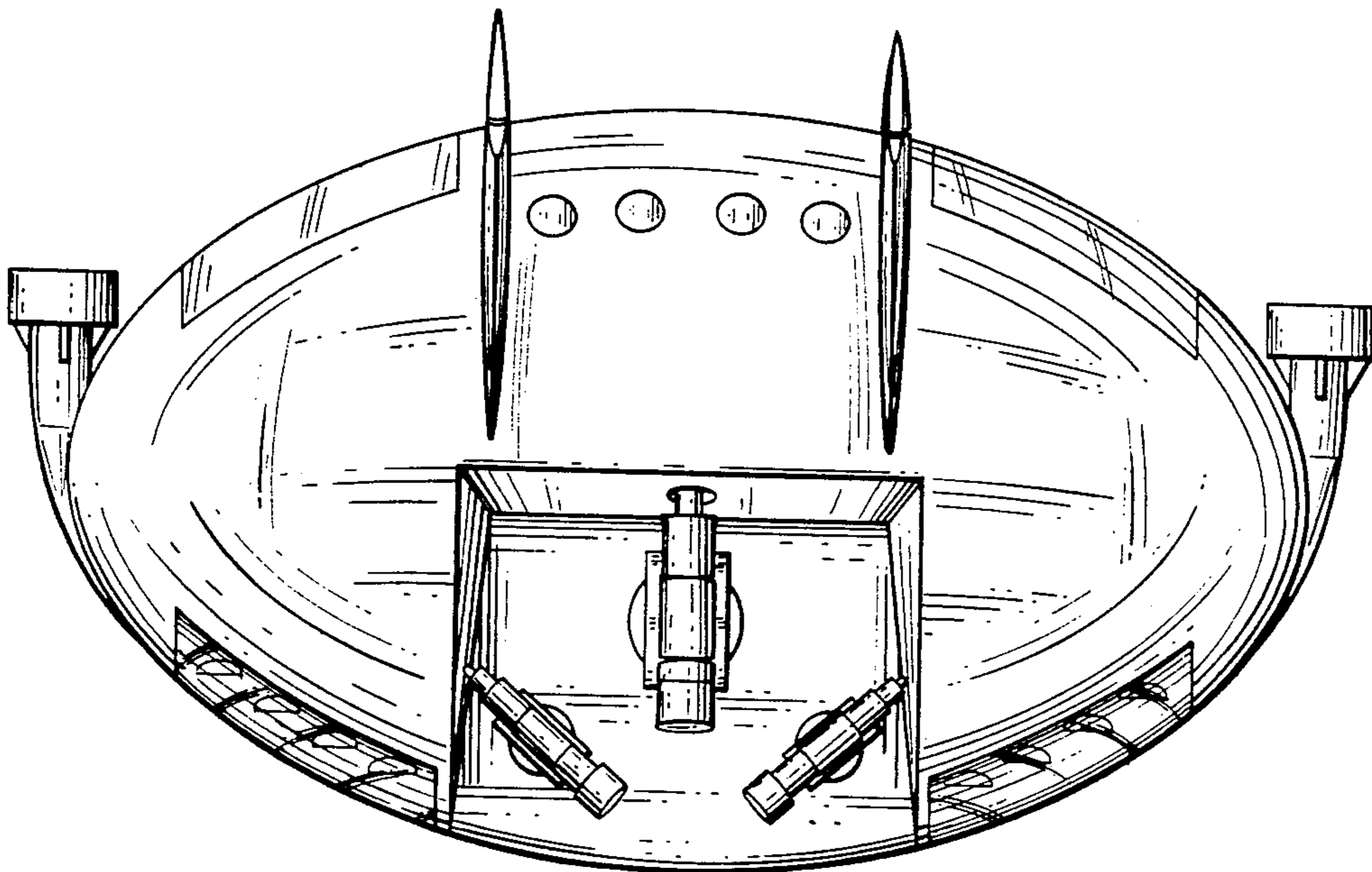

FIG. 6