

[54] MOBILE

[76] Inventor: Andre Jacobs, 24 rue Fernand Neuray, Ixelles, Belgium

[**] Term: 3½ Years

[21] Appl. No.: 943,985

[22] Filed: Sep. 20, 1978

[51] Int. Cl. D11-02

[52] U.S. Cl. D11/141; D21/89

[58] Field of Search D21/63, 77, 82, 87-89; D11/113, 141, 142, 157; 428/7, 9, 8; 40/477, 613, 617; 46/53, 57

[56] References Cited

U.S. PATENT DOCUMENTS

D. 57,647	4/1921	Harris	D21/89
D. 162,707	4/1951	Benson	D21/88

OTHER PUBLICATIONS

Edmund Scientific Co. Catalog No. 691, 9/1968, p. 59-Mobile (C) at top left.

Boys' Life, Apr. 1977, p. 54-Airplane Mobile at right.

Primary Examiner—Louis S. Zarfes

Attorney, Agent, or Firm—Browdy and Neimark

[57] CLAIM

The ornamental design for a mobile, substantially as is shown and described.

DESCRIPTION

FIG. 1 is a perspective view of a mobile showing my new design;

FIG. 2 is a detailed perspective view of one element thereof;

FIG. 3 is a bottom plan view thereof;

FIG. 4 is a front elevational view thereof; and

FIG. 5 is a side elevational view thereof.

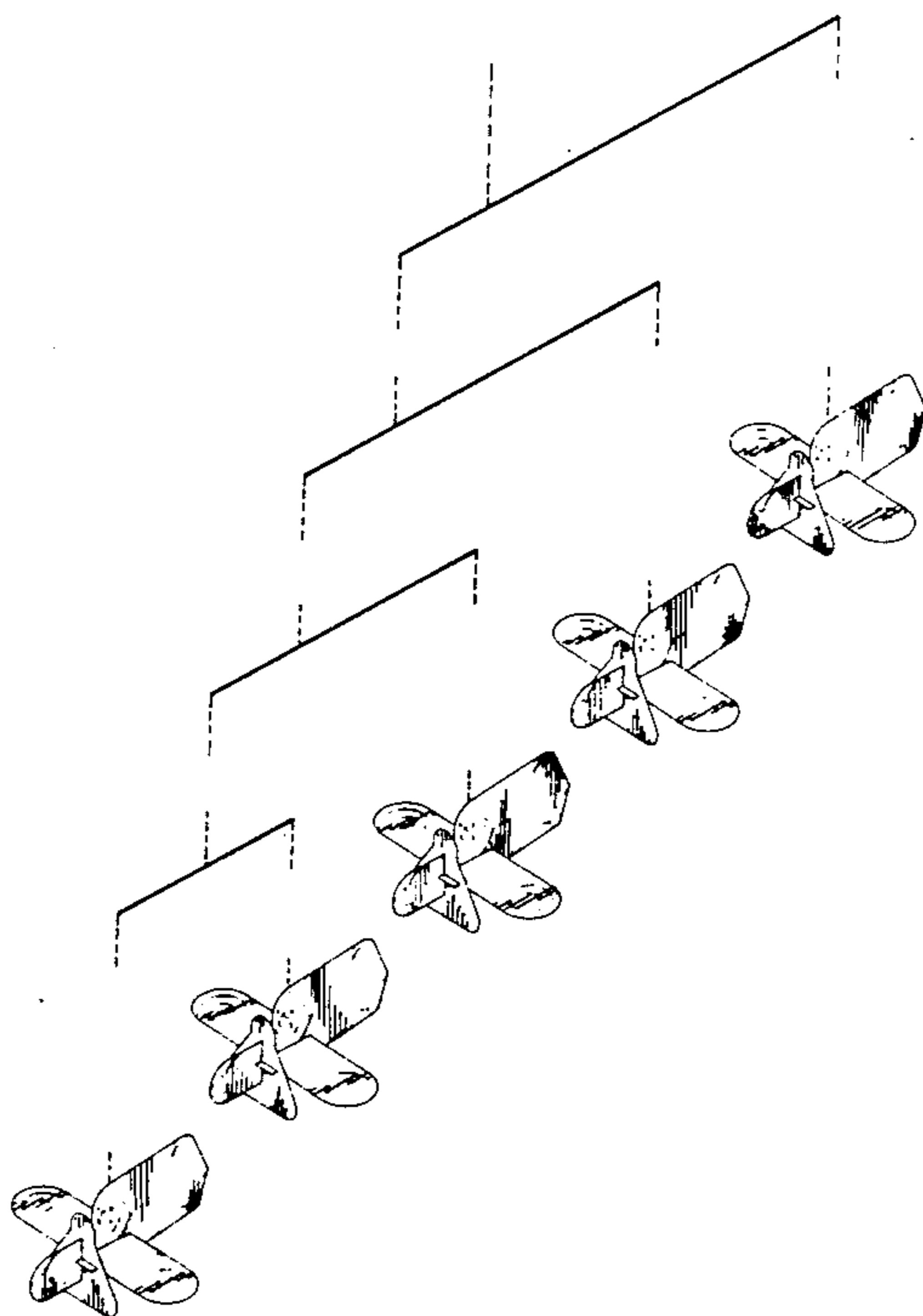

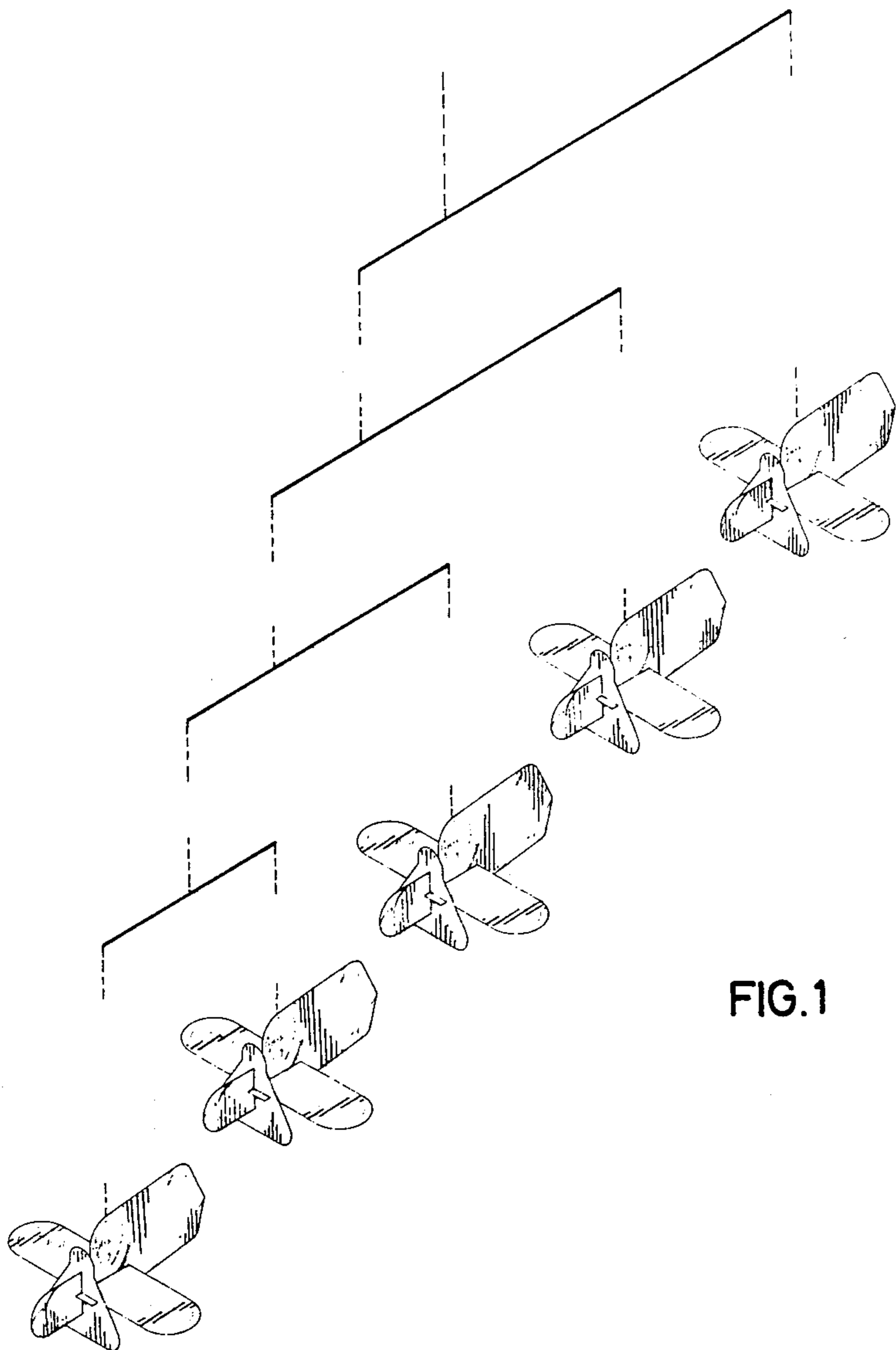

FIG. 1

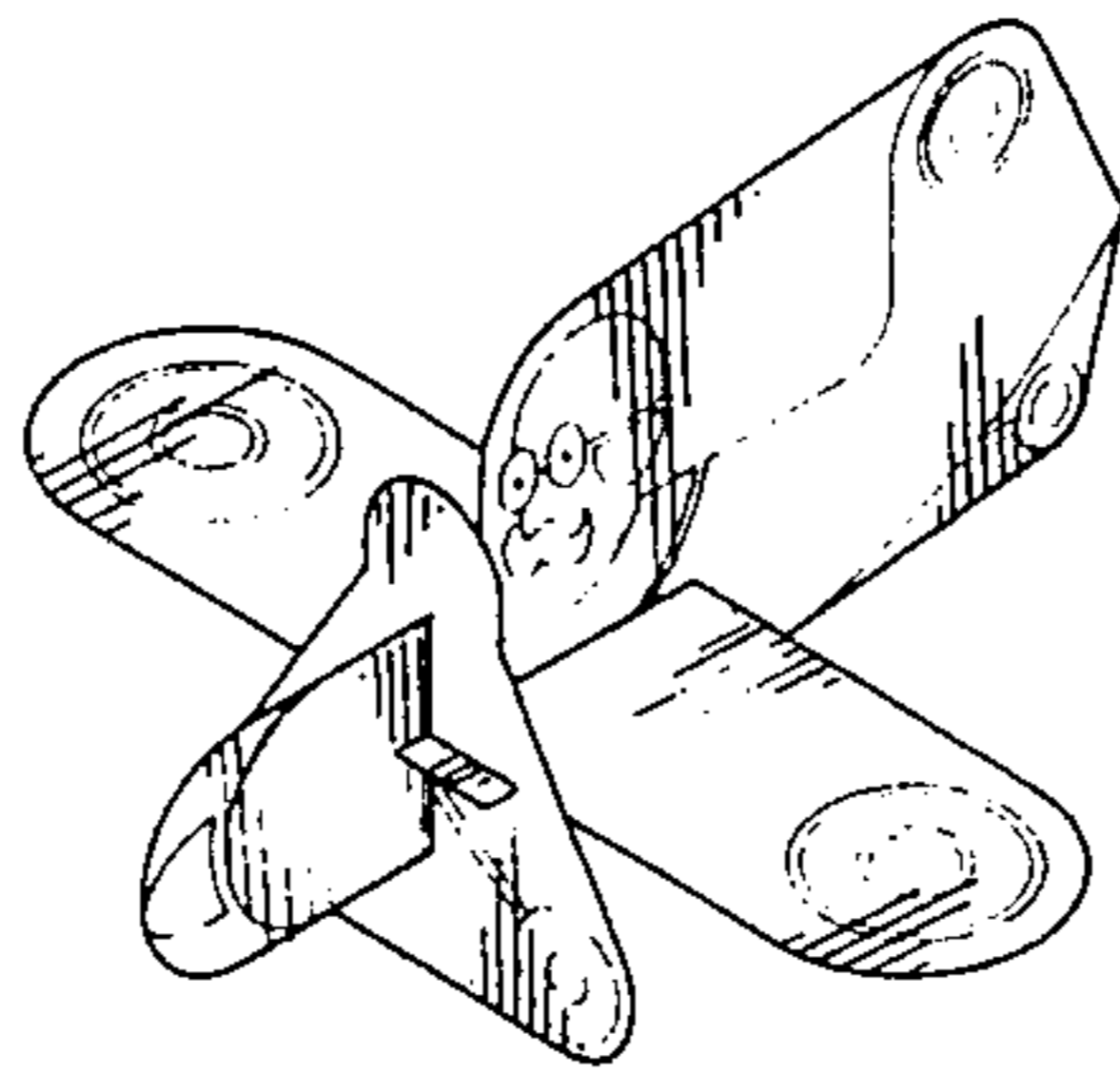

FIG. 2

UNITED STATES PATENT AND TRADEMARK OFFICE
CERTIFICATE OF CORRECTION

PATENT NO. : Des. 259,549

Page 1 of 3

DATED : June 16, 1981

INVENTOR(S) : Andre JACOBS

It is certified that error appears in the above-identified patent and that said Letters Patent are hereby corrected as shown below:

Please correct Fig. 1 as per attached sheet of drawing.

Please add the attached sheet of drawing of Figs. 3-5.

Signed and Sealed this

Seventeenth Day of November 1981

[SEAL]

Attest:

GERALD J. MOSSINGHOFF

Attesting Officer

Commissioner of Patents and Trademarks

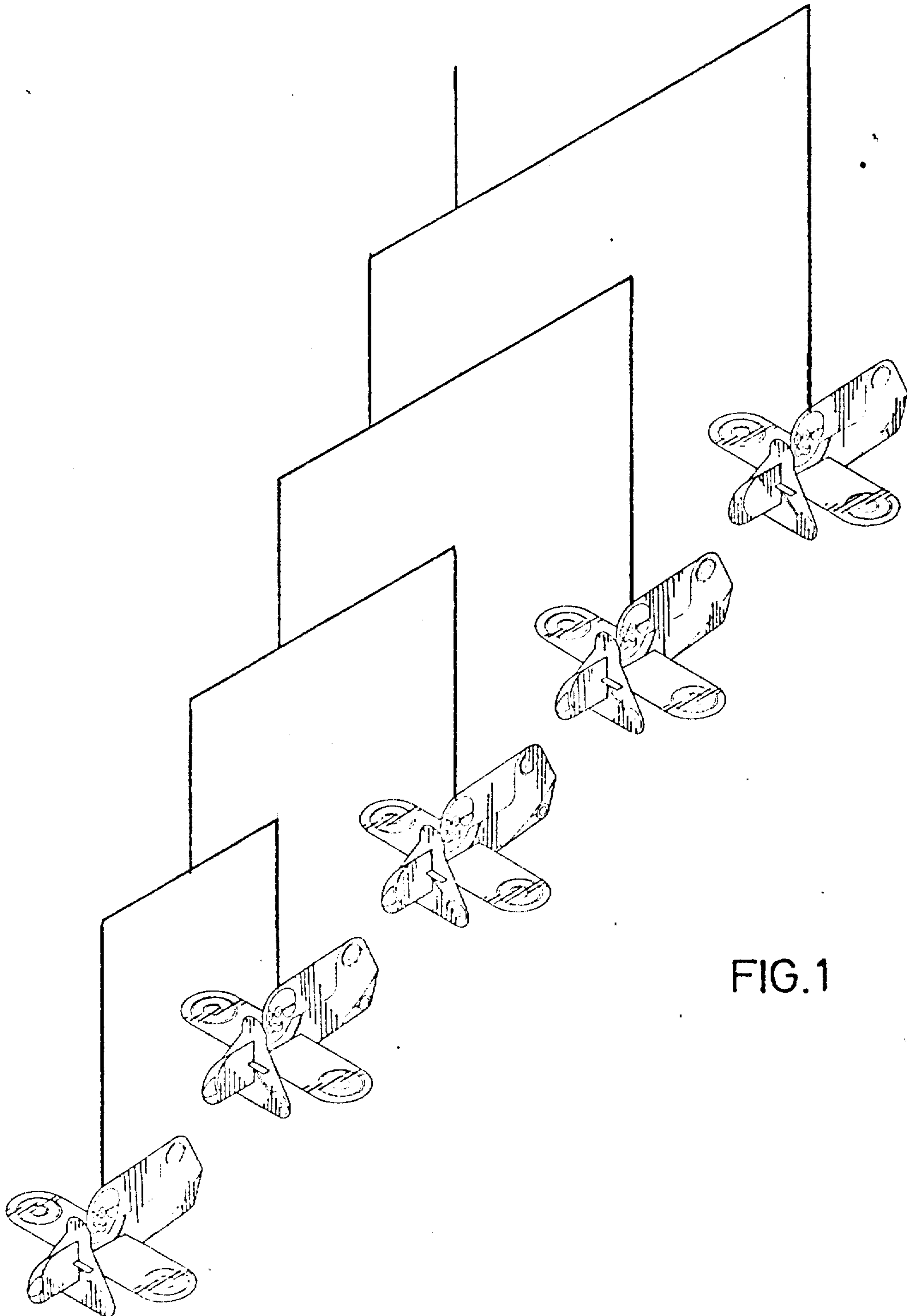

FIG.1

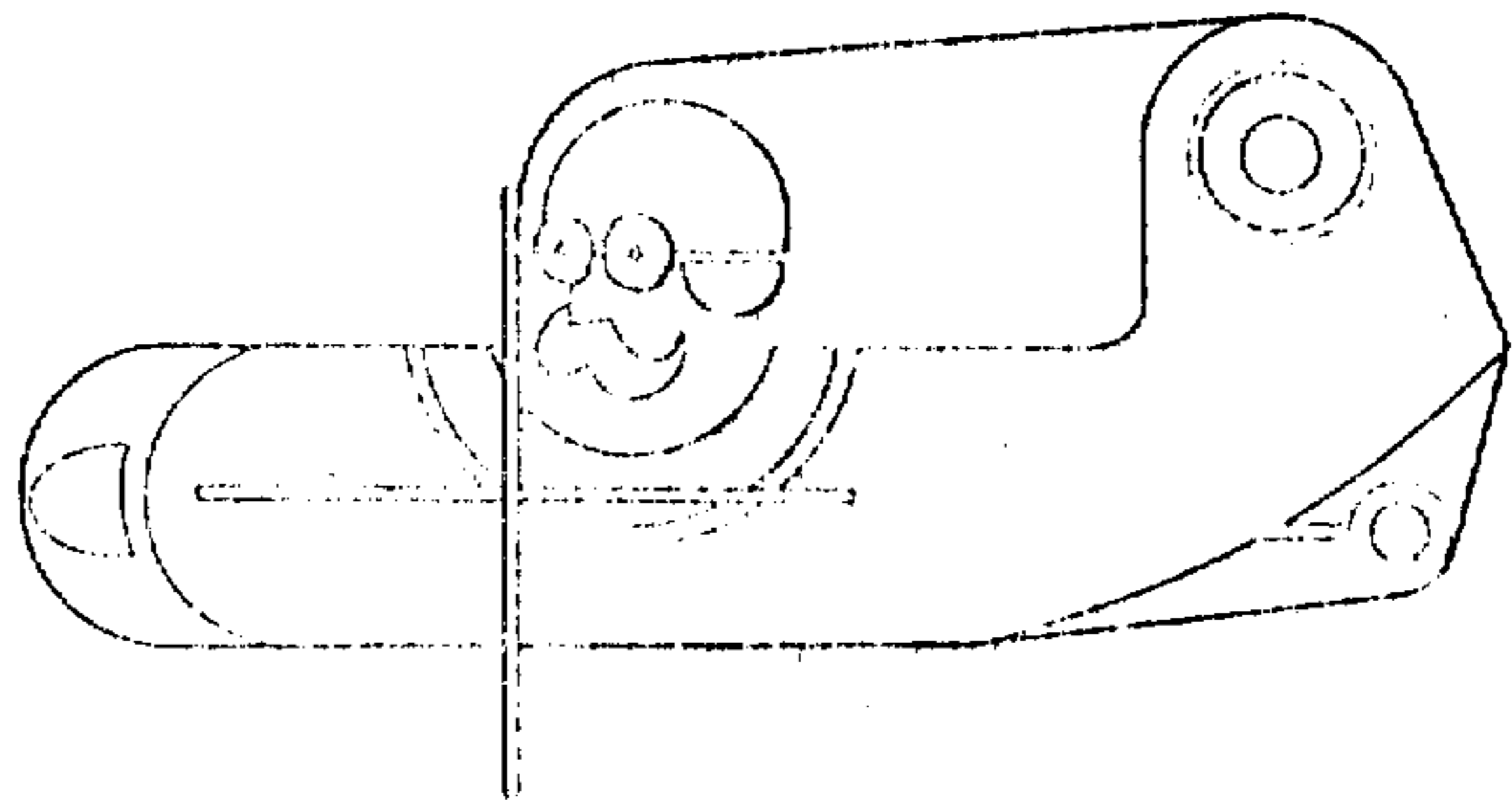

FIG. 5

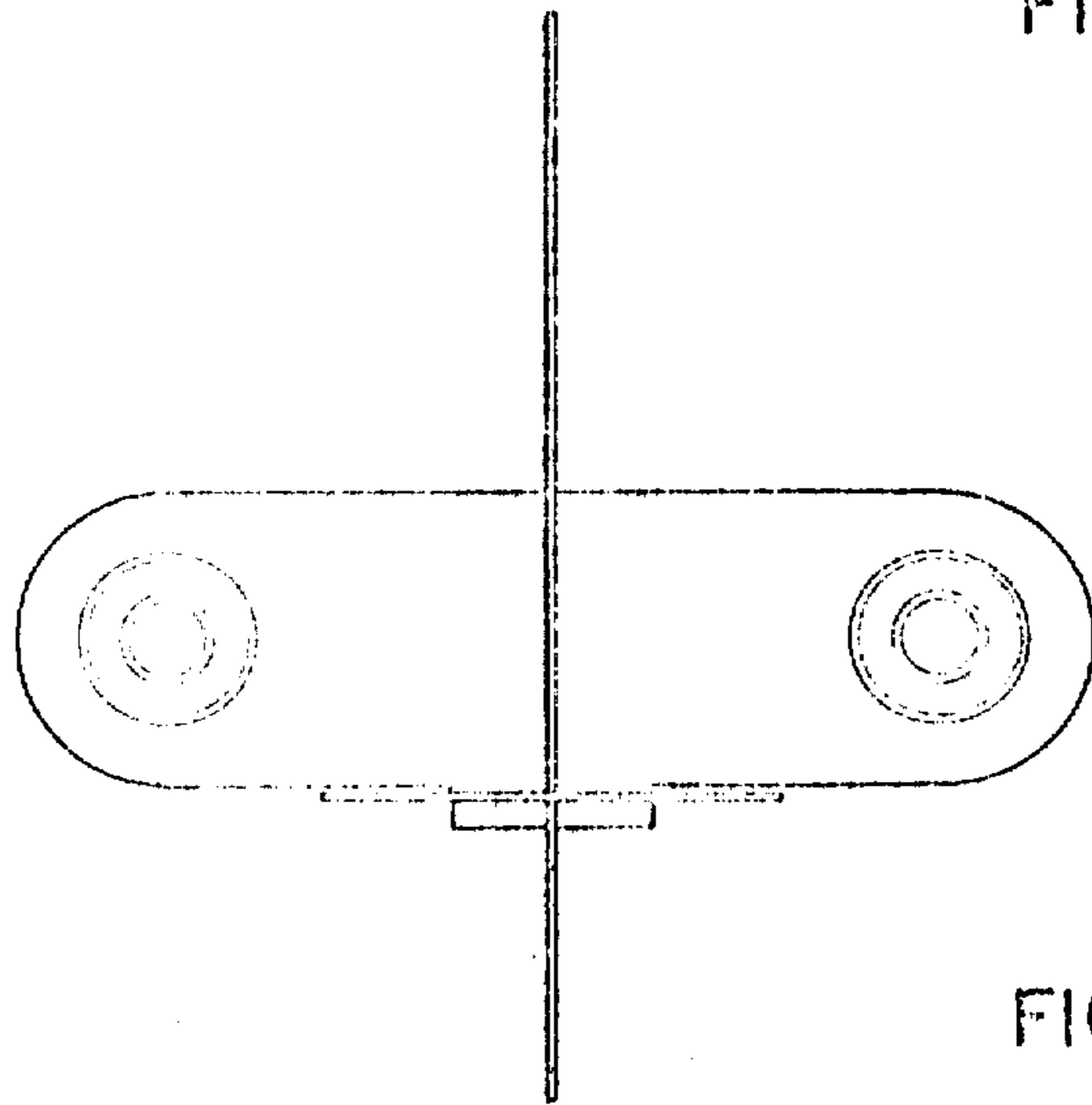

FIG. 3

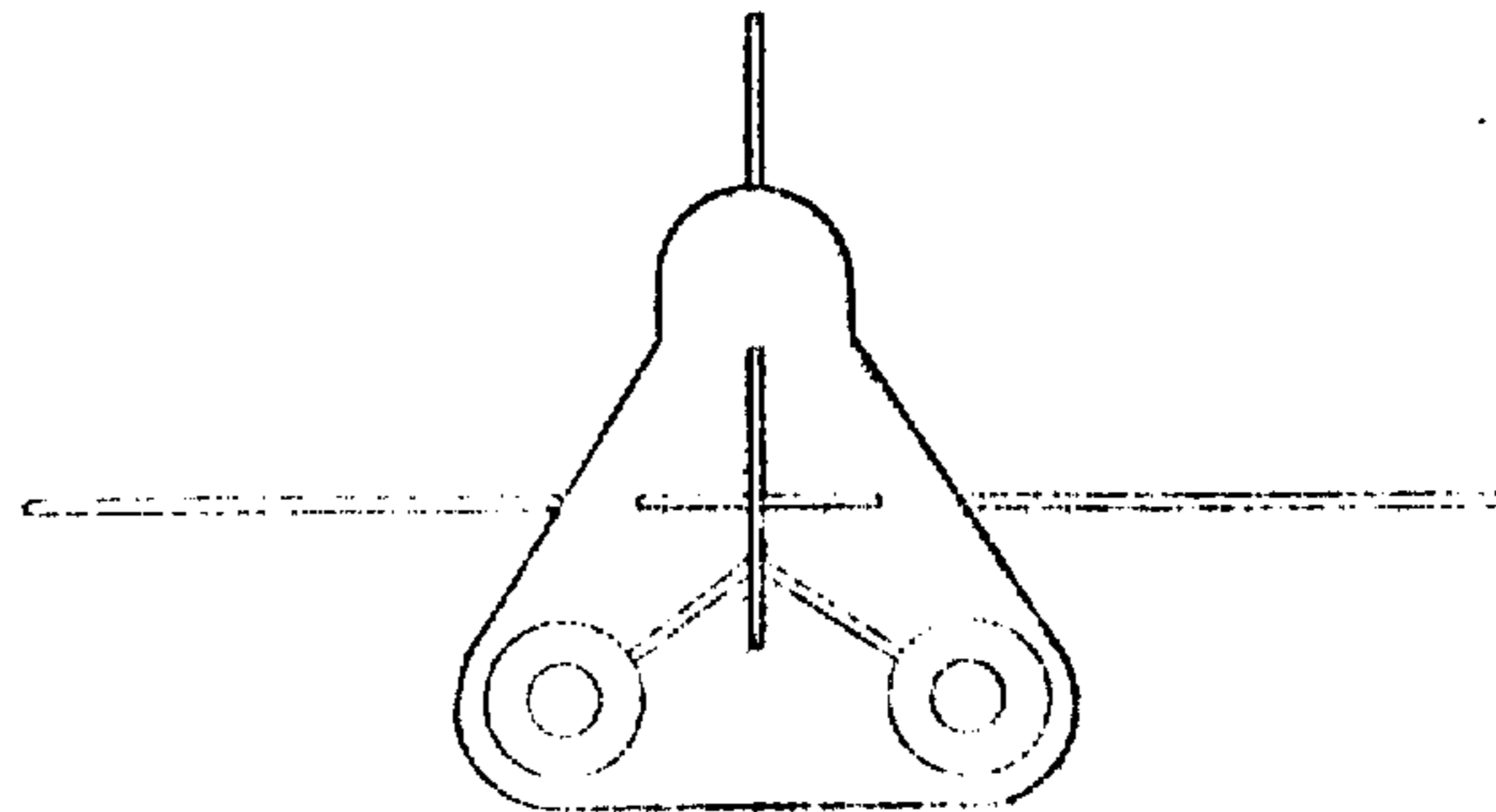

FIG. 4