

[54] STILL CAMERA WITH INTEGRAL FLASH

[75] Inventor: Samuel F. Swayze, Rochester, N.Y.

[73] Assignee: Eastman Kodak Company, Rochester, N.Y.

[\*\*] Term: 14 Years

[21] Appl. No.: 958,841

[22] Filed: Oct. 30, 1978

[51] Int. Cl. .... D16-01

[52] U.S. Cl. .... D16/06

[58] Field of Search ..... D16/1-10; 354/126, 145, 152, 158, 170, 173, 174, 187, 202, 288

[56] References Cited

U.S. PATENT DOCUMENTS

- D. 244,525 5/1977 Ishino ..... D16/9
- D. 244,851 6/1977 Masuyama ..... D16/6
- D. 246,652 12/1977 Ooya et al. .... D16/6

FOREIGN PATENT DOCUMENTS

- 2338794 2/1975 Fed. Rep. of Germany ..... 354/288
- 2725642 12/1977 Fed. Rep. of Germany ..... 354/145
- 2639443 3/1978 Fed. Rep. of Germany ..... 354/145

Primary Examiner—Catherine E. Kemper  
Attorney, Agent, or Firm—D. R. Arndt

[57] CLAIM

The ornamental design for a still camera with integral flash or similar article, as shown and described.

DESCRIPTION

FIG. 1 is a top, front and right side perspective view with the flash in the closed position;  
 FIG. 2 is a rear, bottom and left side perspective view thereof;  
 FIG. 3 is a front elevational view thereof;  
 FIG. 4 is a top plan view thereof;  
 FIG. 5 is a bottom plan view thereof;  
 FIG. 6 is a rear elevational view thereof;  
 FIG. 7 is a left side elevational view thereof;  
 FIG. 8 is a right side elevational view thereof;  
 FIG. 9 is a top, front and right side perspective view with the flash in its operative position;  
 FIG. 10 is a bottom, rear and left side perspective view of FIG. 9;  
 FIG. 11 is a front elevational view of FIG. 9;  
 FIG. 12 is a top plan view of FIG. 9;  
 FIG. 13 is a bottom plan view of FIG. 9;  
 FIG. 14 is a rear elevational view of FIG. 9; and  
 FIG. 15 is a right side elevational view of FIG. 9.

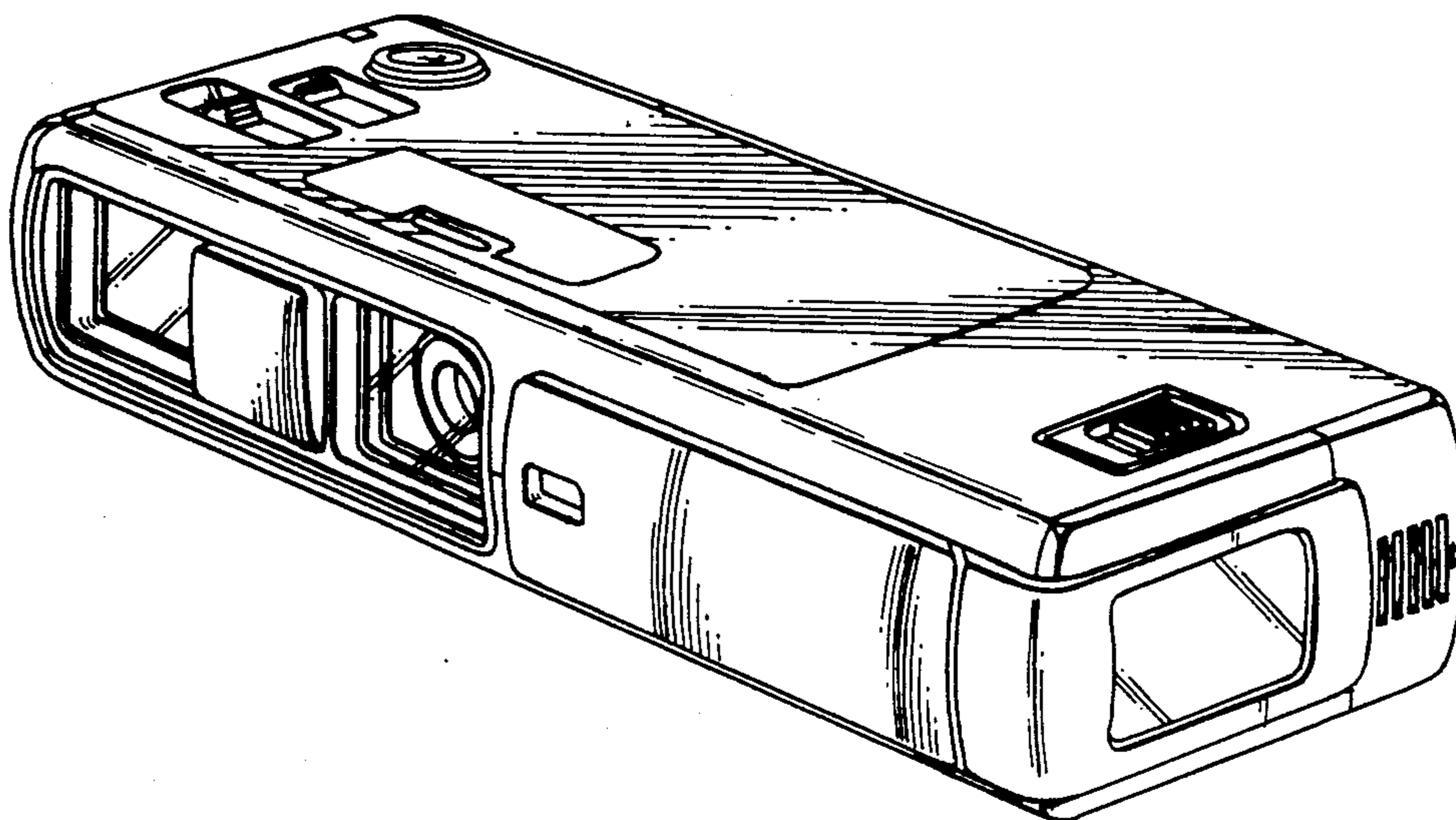

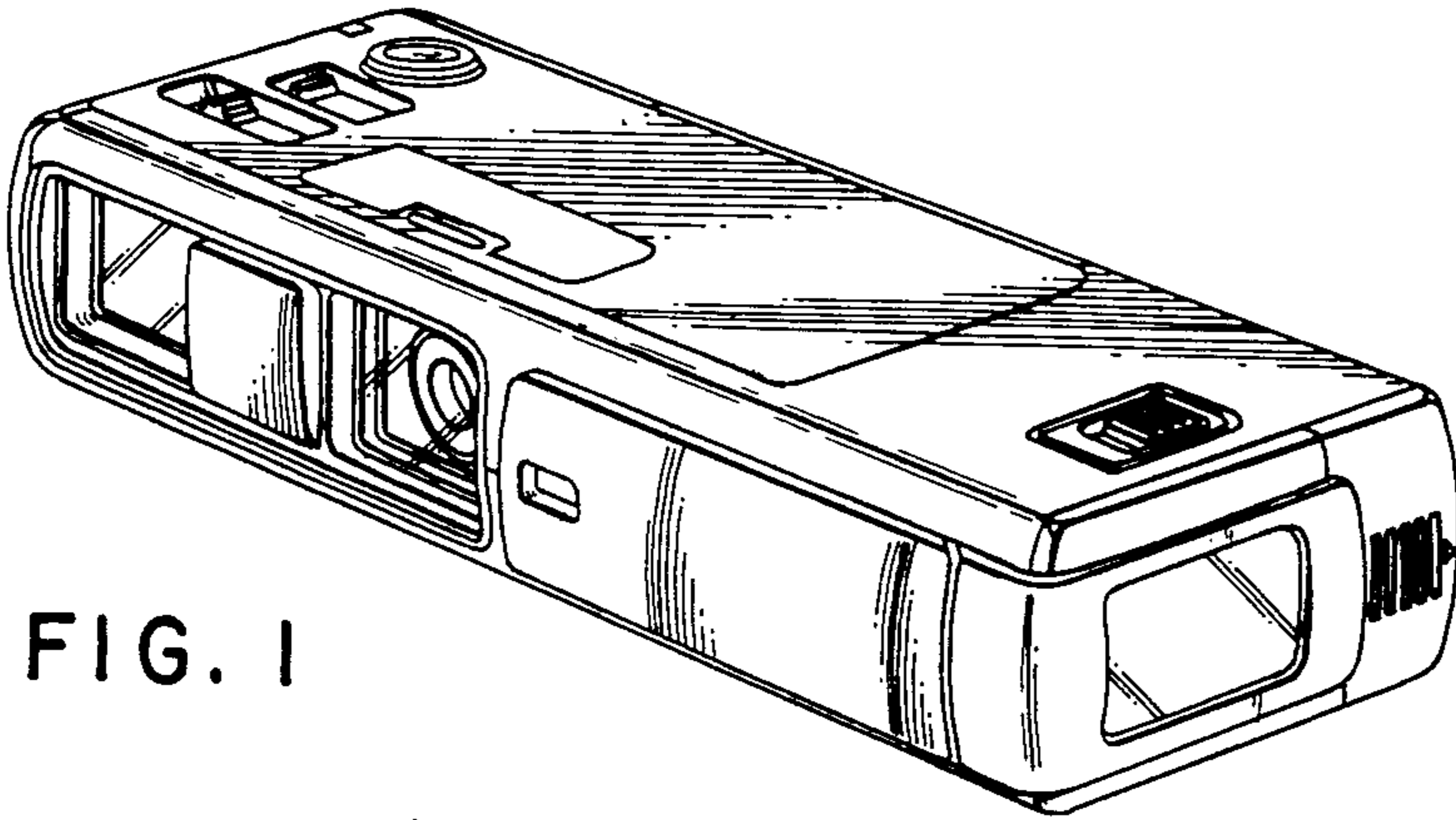

FIG. 1

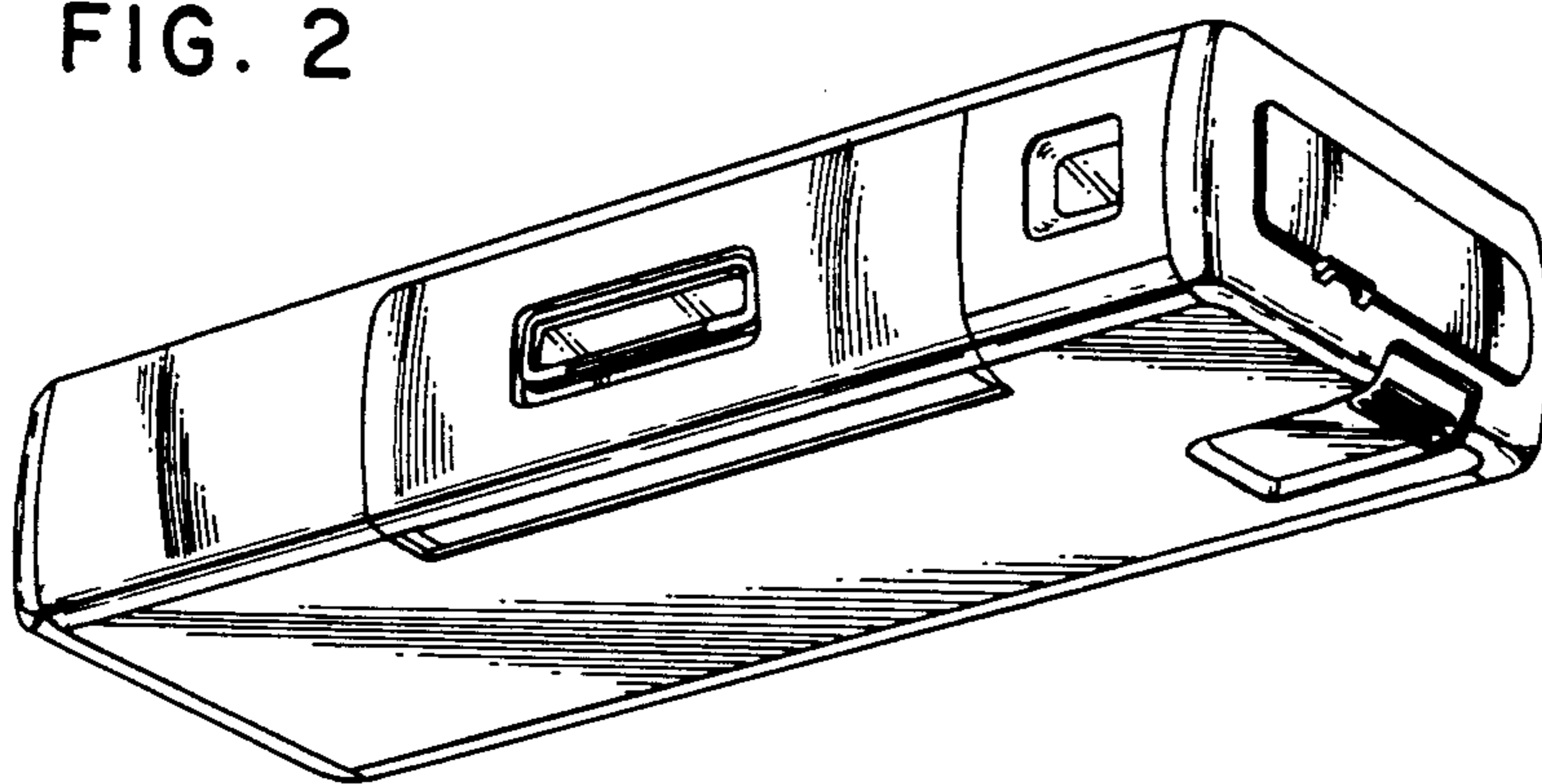
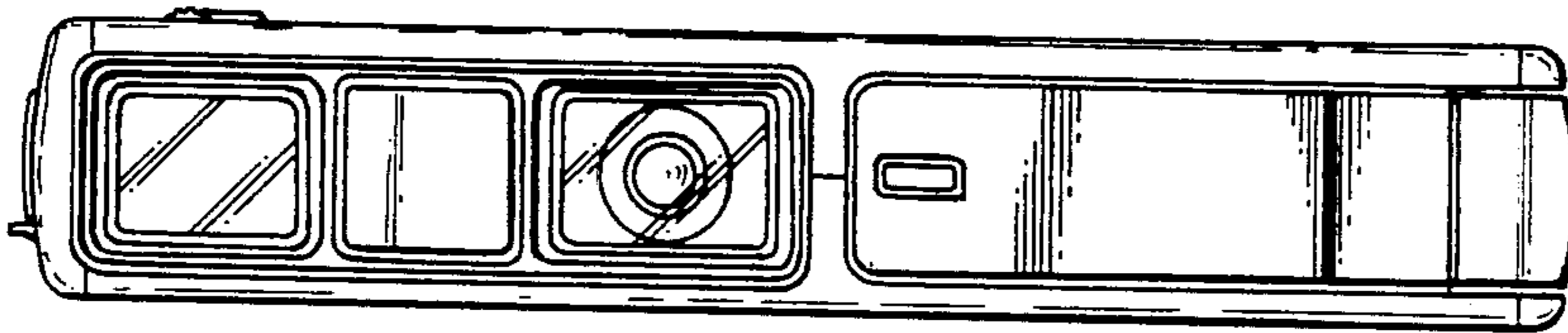

FIG. 2

FIG. 3



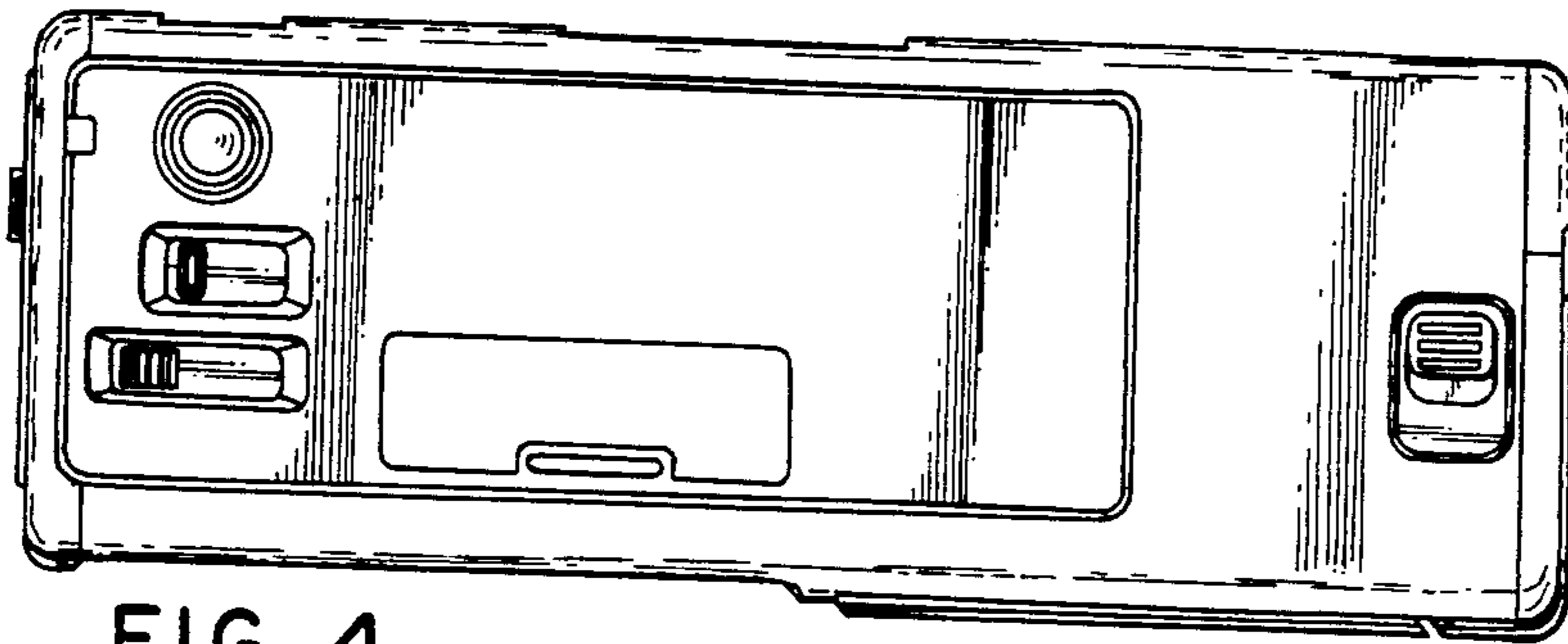

FIG. 4

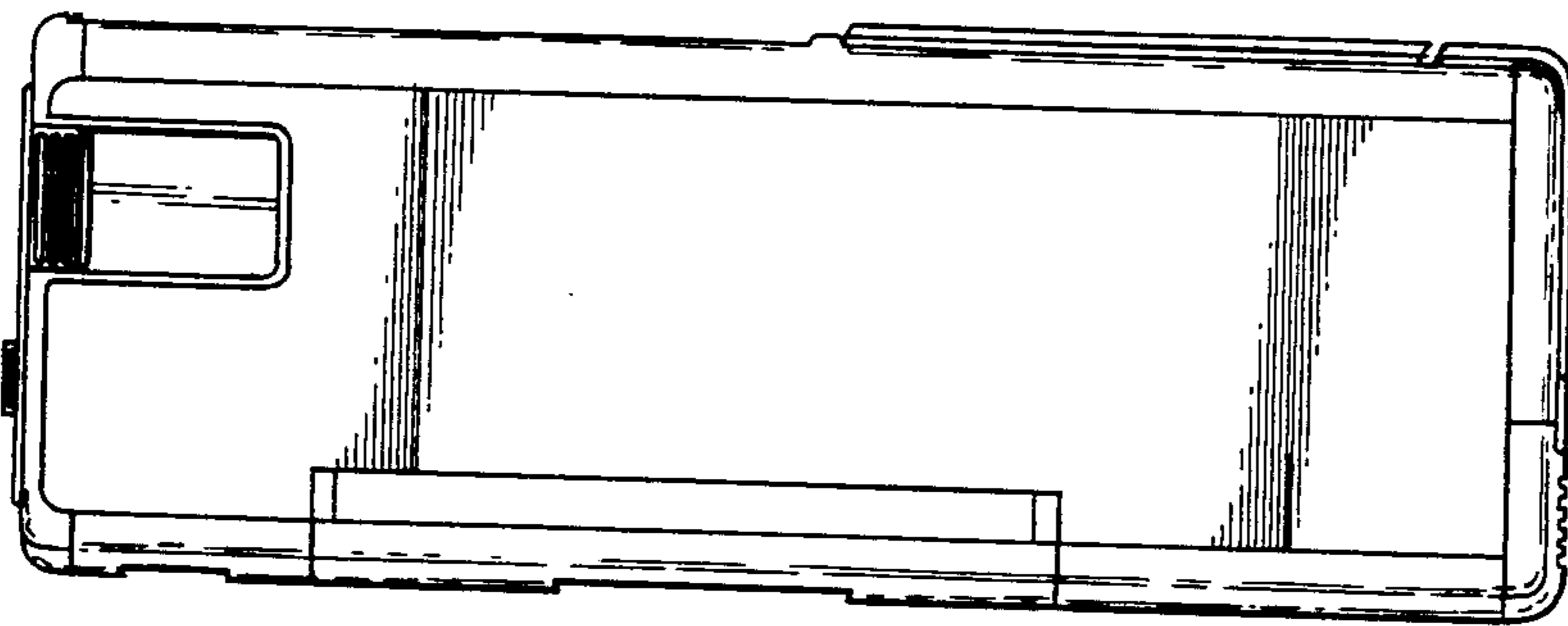

FIG. 5

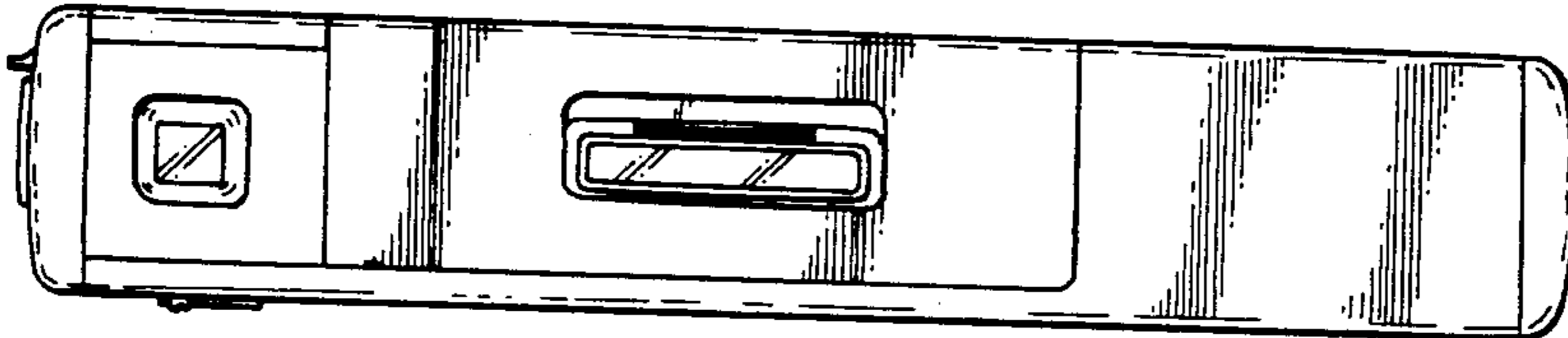

FIG. 6

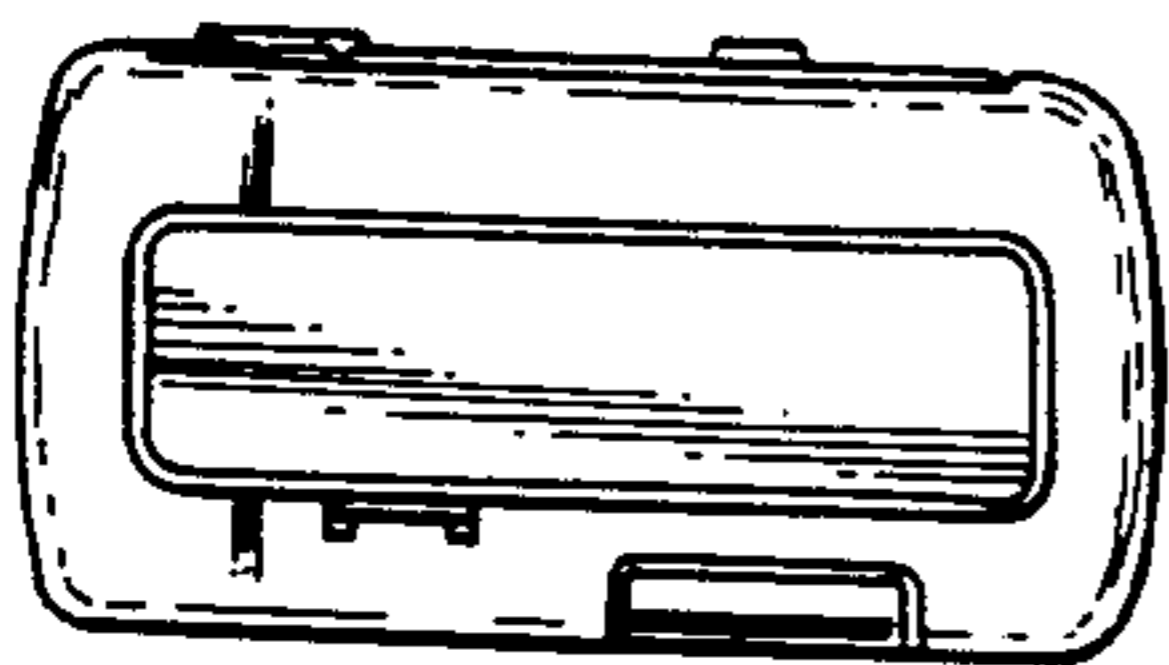

FIG. 7

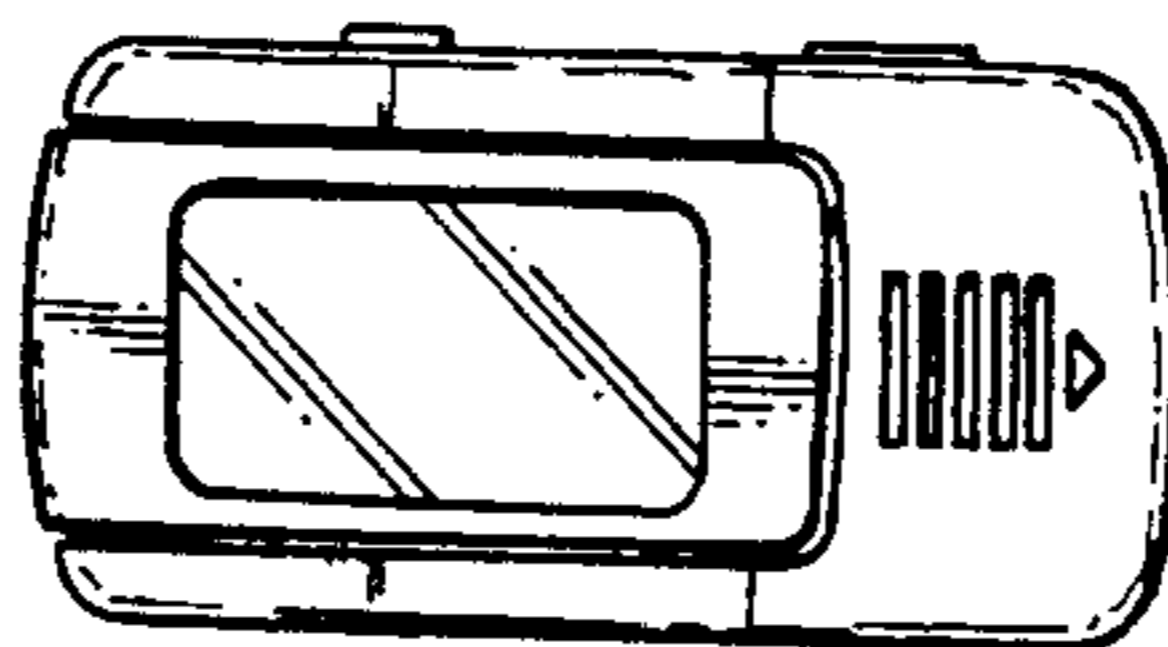

FIG. 8

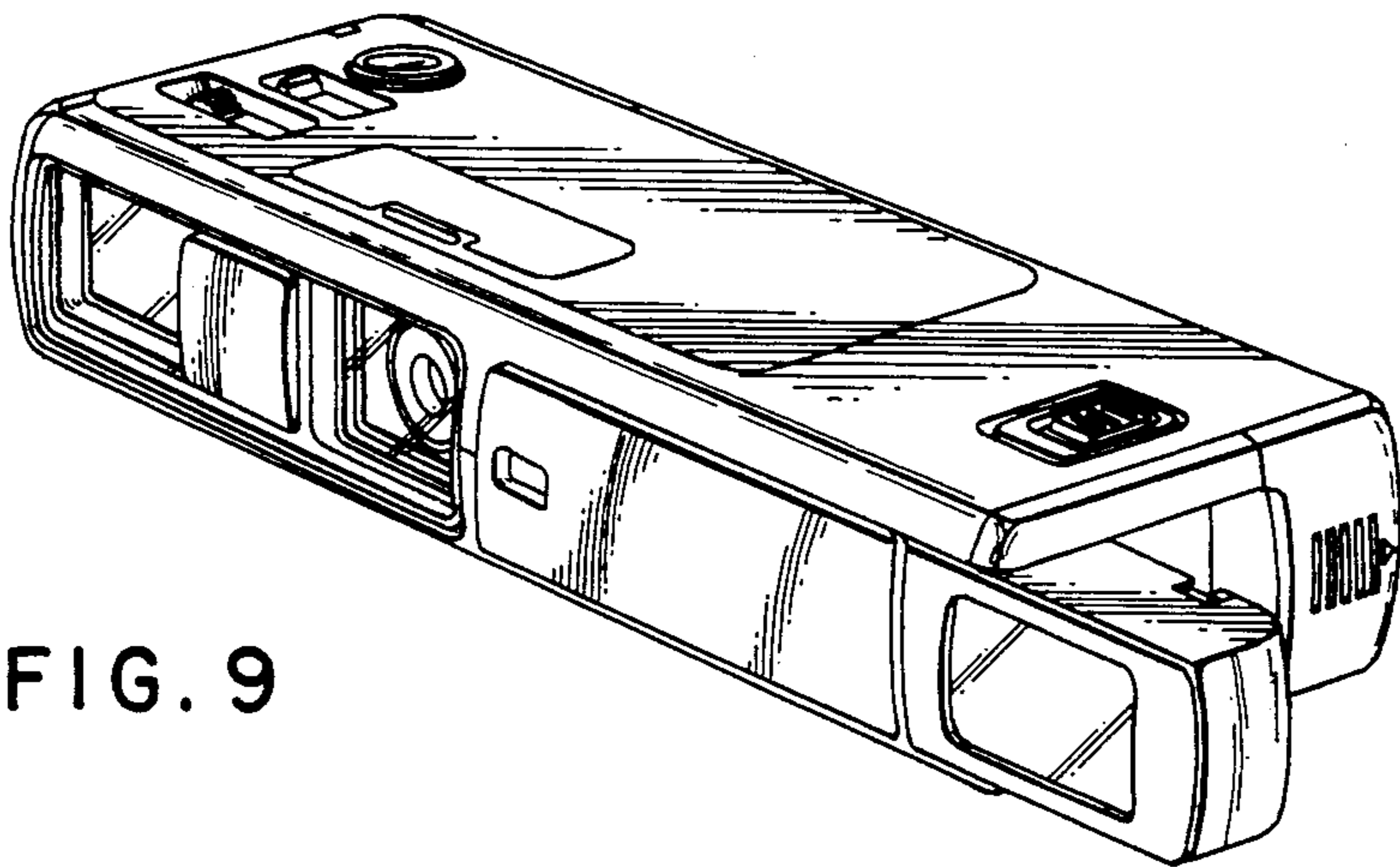

FIG. 9

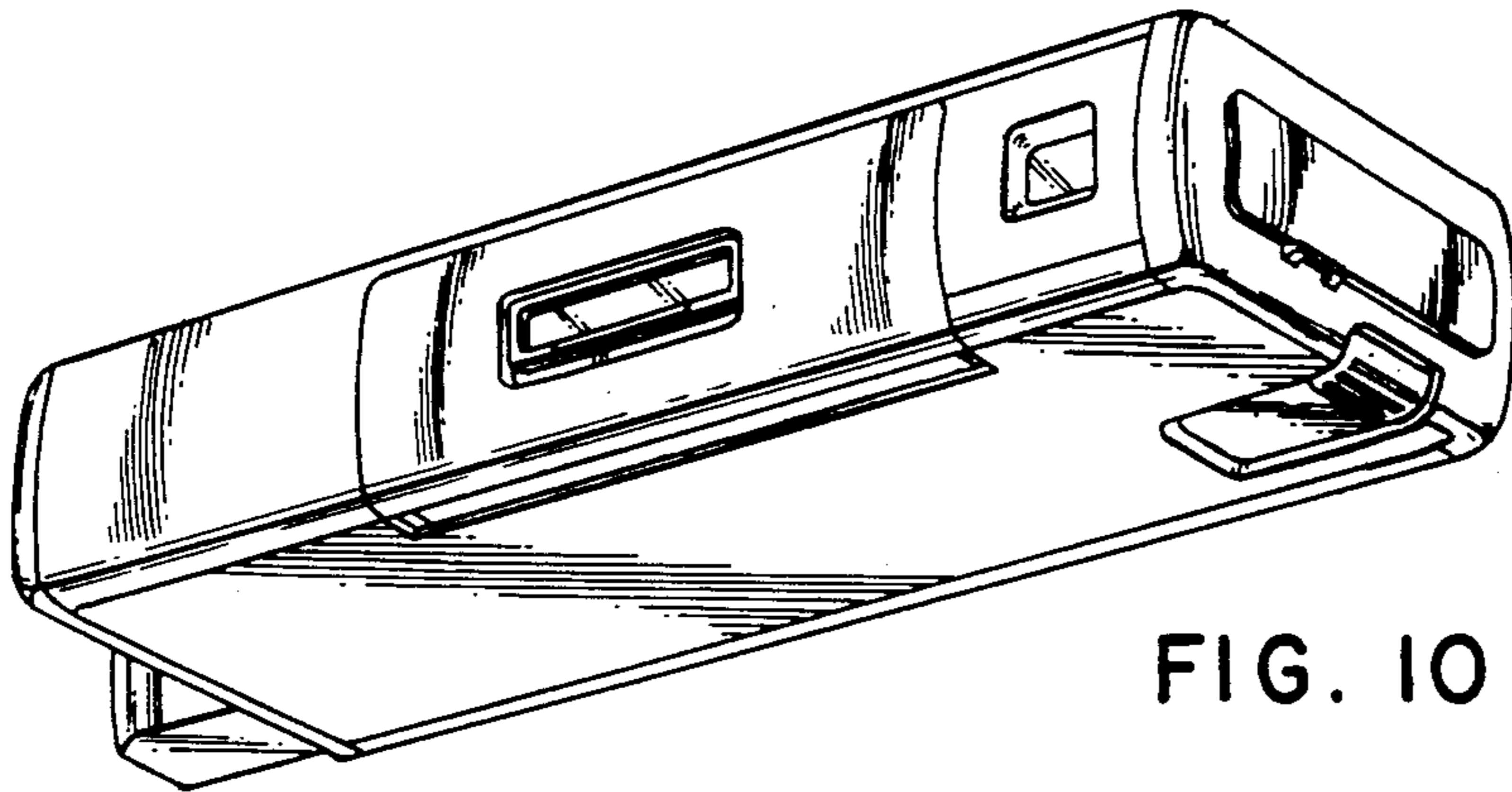

FIG. 10

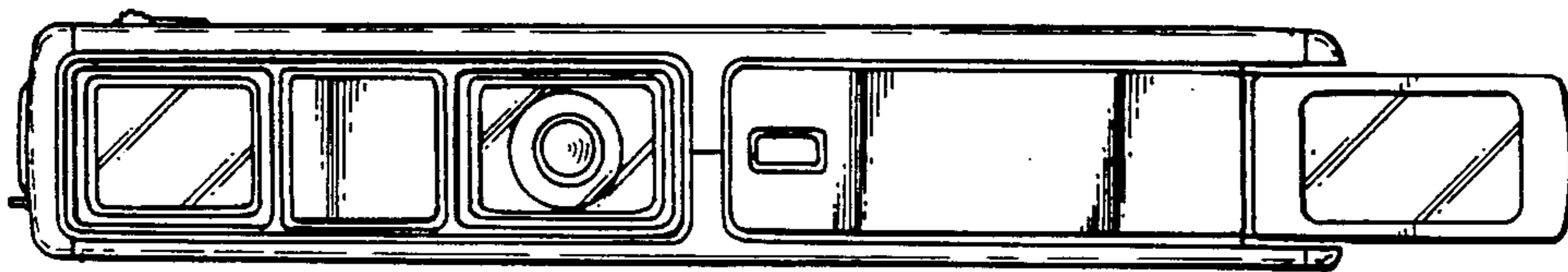

FIG. 11

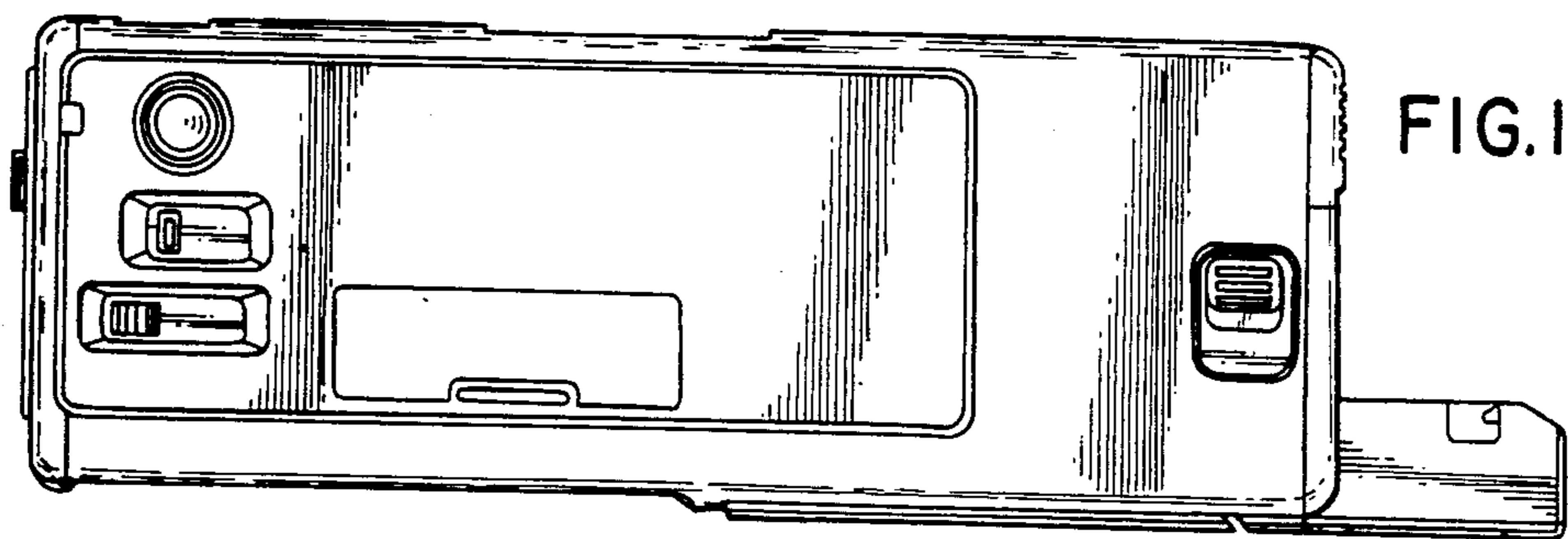

FIG. 12

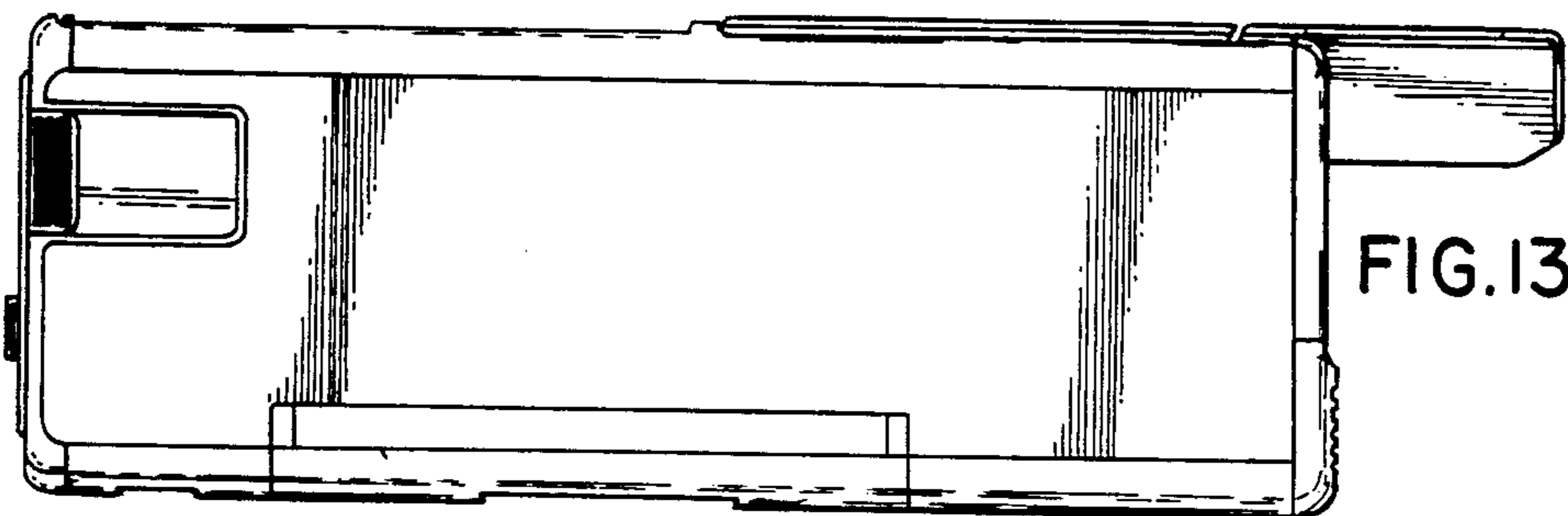

FIG. 13

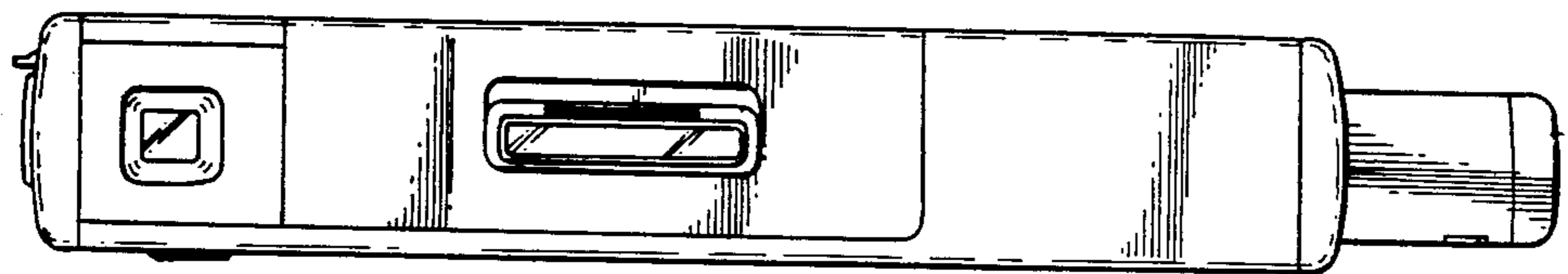

FIG. 14

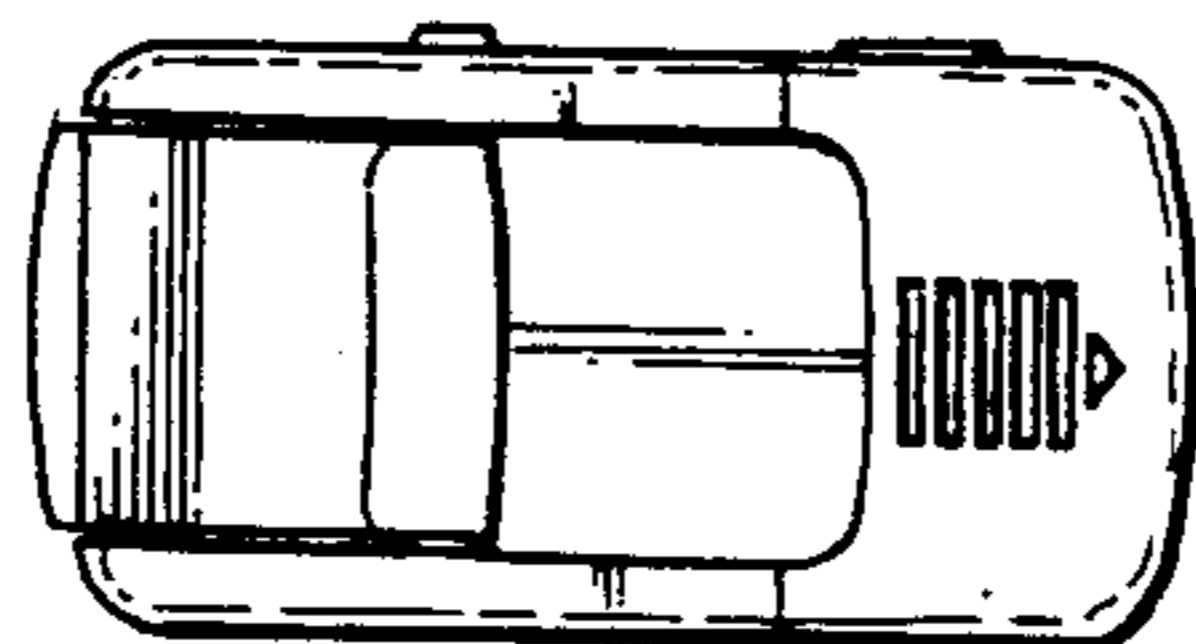

FIG. 15