

[54] WOODWORKING CLAMP

[76] Inventor: Irving Sloane, Millerton, N.Y. 12546

[**] Term: 14 Years

[21] Appl. No.: 961,395

[22] Filed: Nov. 16, 1978

[51] Int. Cl. D8-05

[52] U.S. Cl. D8/72; D8/74

[58] Field of Search D8/71, 72, 74; 269/166, 269/236, 239

[56] References Cited

U.S. PATENT DOCUMENTS

D. 134,313	11/1942	Yates	D8/72
D. 193,736	10/1962	Yandt	D8/72
3,575,405	4/1971	Harding	D8/72
4,143,869	3/1979	Paterson et al.	269/166

Primary Examiner—Sam Rosen

Attorney, Agent, or Firm—S. Stephen Baker

[57] CLAIM

The ornamental design for a woodworking clamp, as shown.

DESCRIPTION

FIG. 1 is a front elevational view of a woodworking clamp showing my new design;

FIG. 2 is an enlarged top plan view thereof;

FIG. 3 is an enlarged side elevational view thereof with the guide partly broken away for convenience of illustration;

FIG. 4 is an enlarged side elevational view of the side opposite that shown in FIG. 3 with the guide partly broken away for convenience of illustration;

FIG. 5 is an enlarged bottom plan view thereof;

FIG. 6 is a front elevational view thereof showing the upper jaw raised and the cam lever in engaging position; and

FIG. 7 is a reduced perspective view thereof showing the upper jaw raised and the cam lever in non-engaging position.

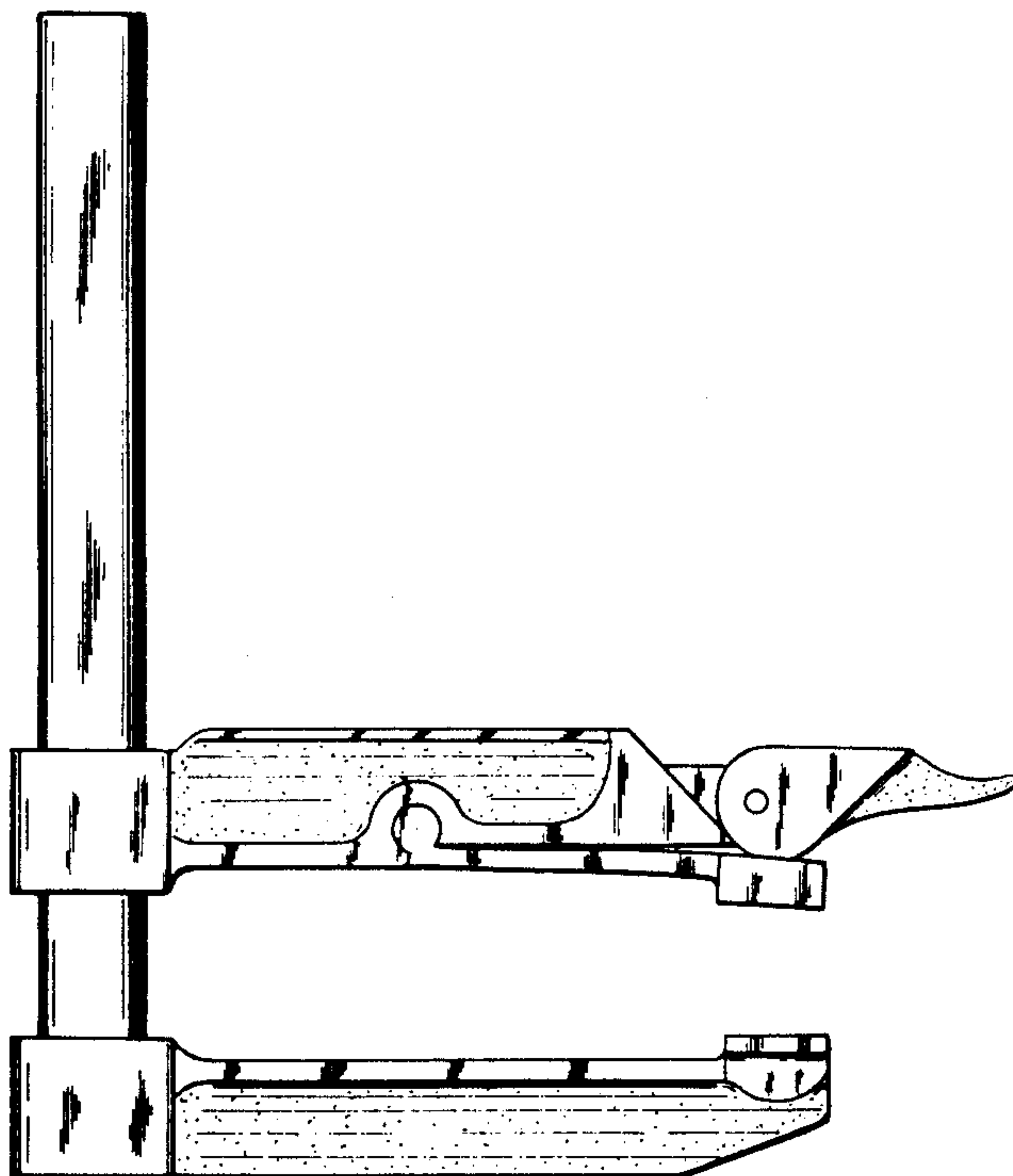

FIG. 2

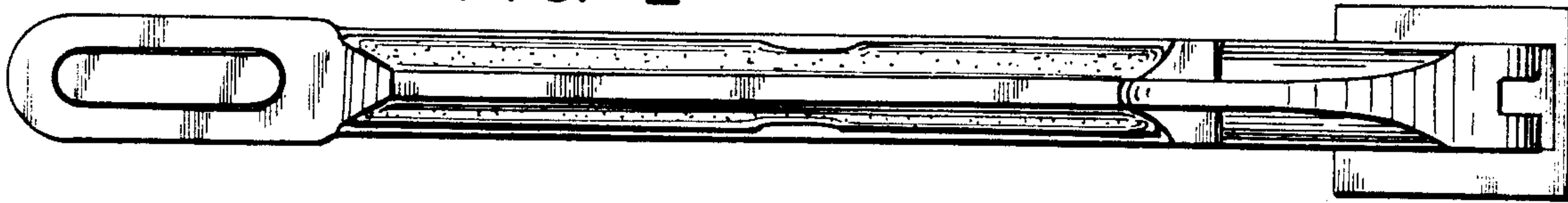

FIG. 4

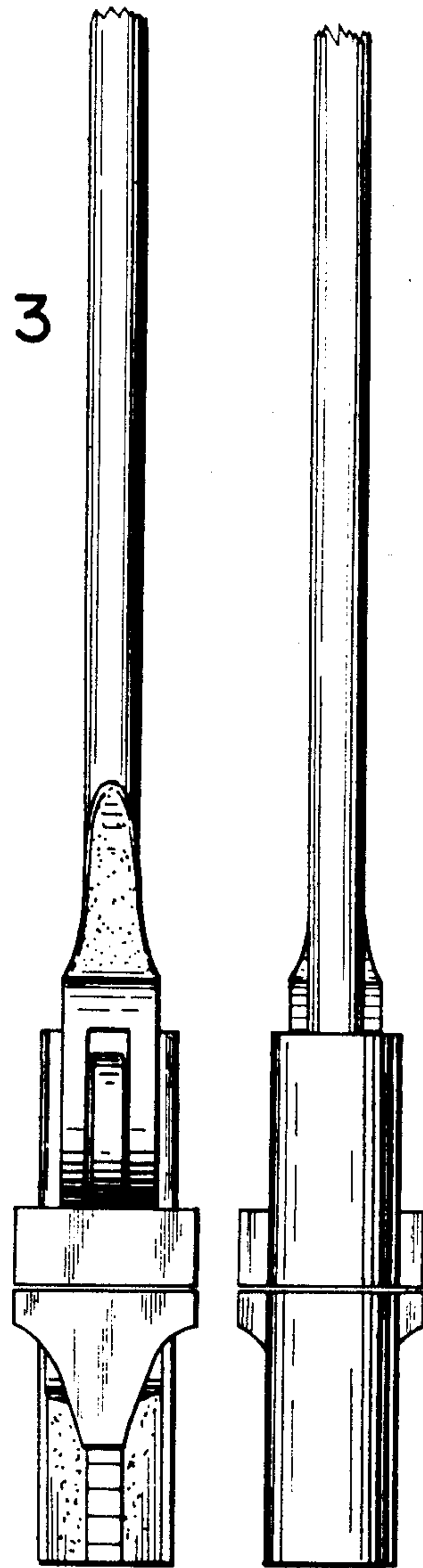

FIG. 3

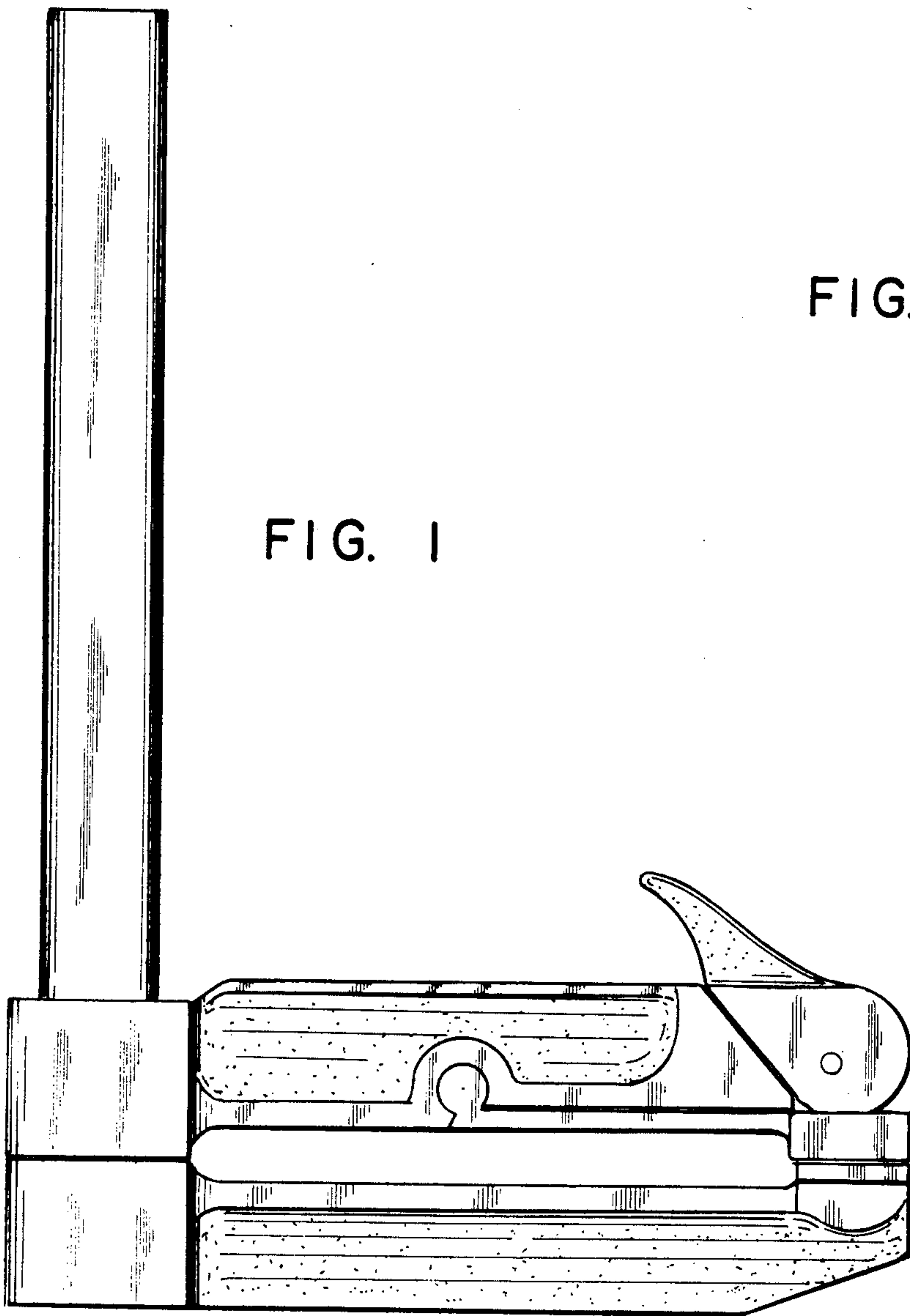

FIG. 1

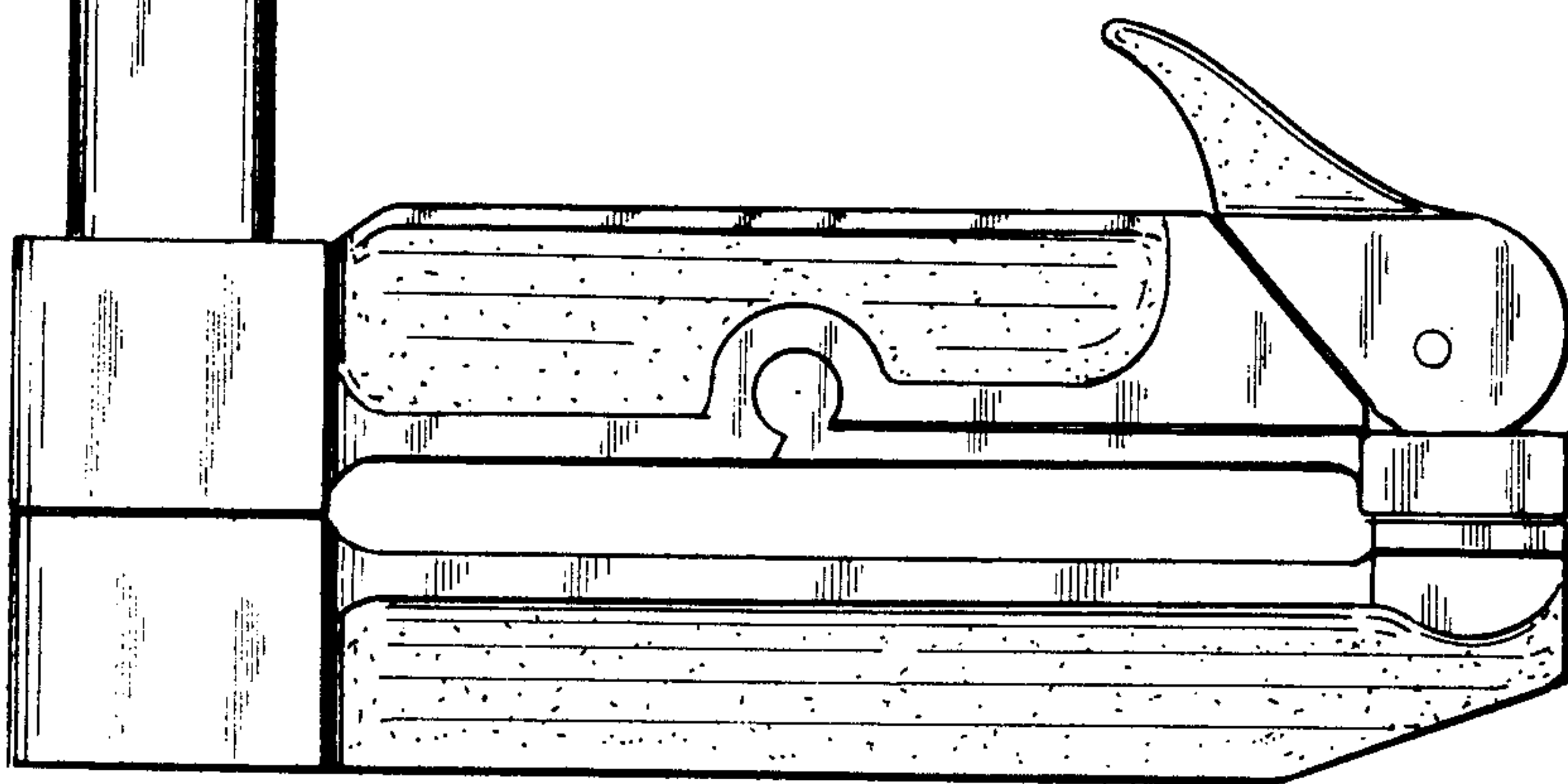

FIG. 5

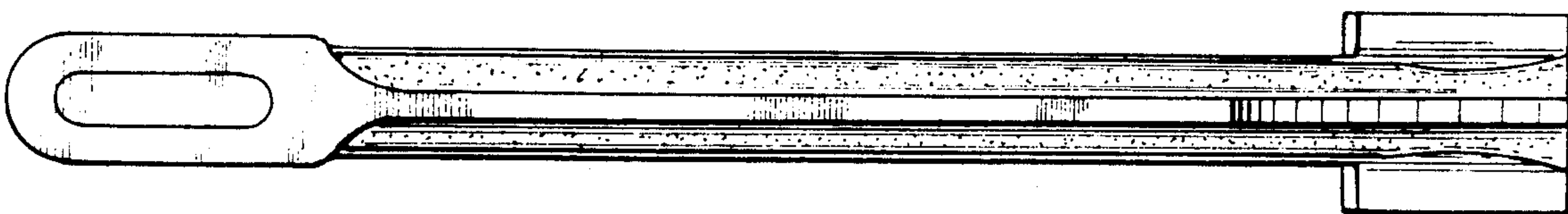

FIG. 7

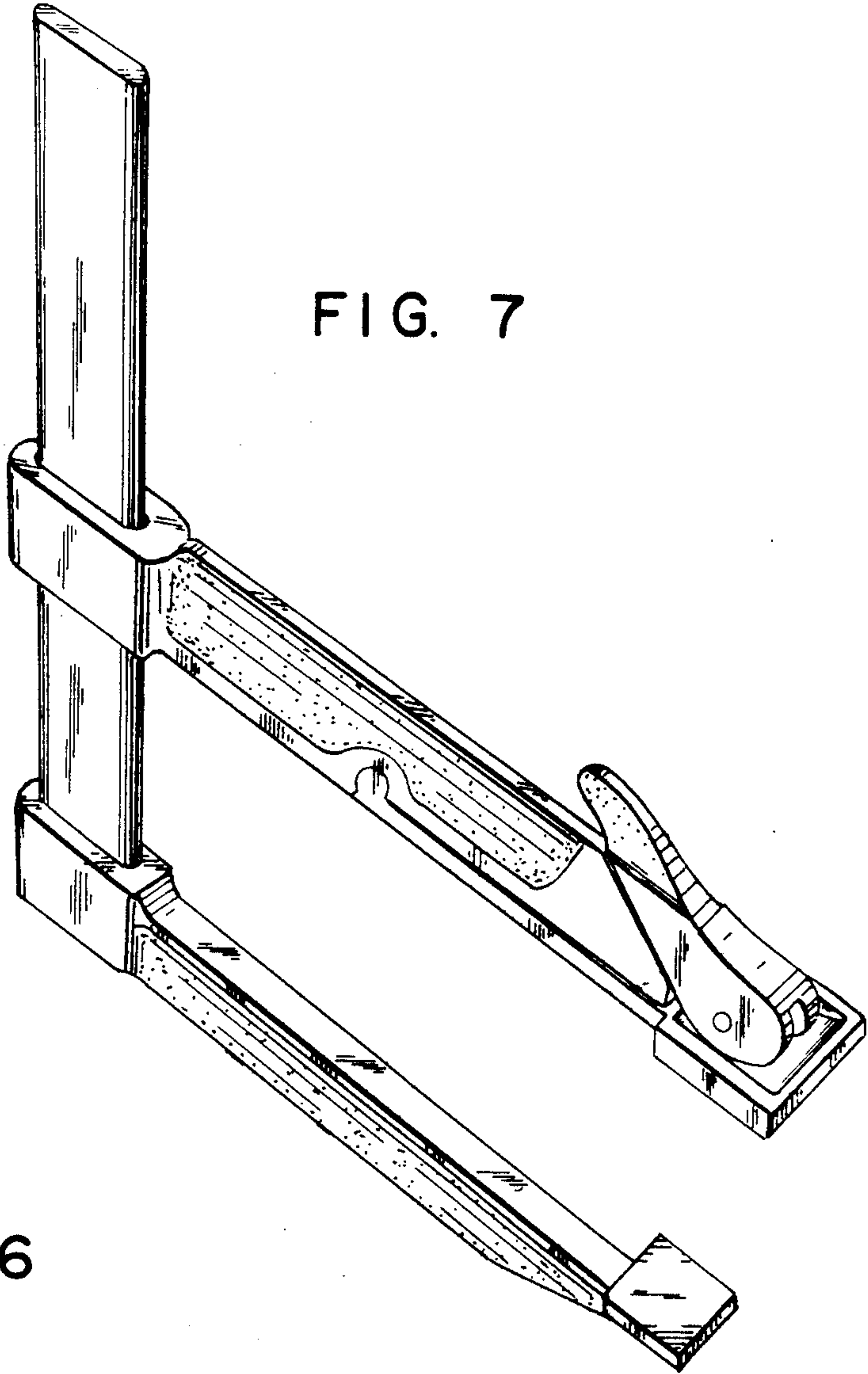

FIG. 6

