

[54] ELECTRONIC BASEBALL GAME CASING

[75] Inventors: Jeffrey P. Heuel, Riverside; William F. Palisek, Mundelein, both of Ill.

[73] Assignee: Interstate Industries, Inc., Mundelein, Ill.

[\*\*] Term: 14 Years

[21] Appl. No.: 52,001

[22] Filed: Jun. 28, 1979

[51] Int. Cl. .... D21-01

[52] U.S. Cl. .... D21/13; D21/28

[58] Field of Search ..... D21/13, 28; D18/7; D19/62; 273/85 G, 88, 1 E, 138 A

[56] References Cited

U.S. PATENT DOCUMENTS

D. 123,677 11/1940 Lyman ..... D21/28

OTHER PUBLICATIONS

Montgomery Ward Xmas Cat., 1977, p. 429, top, item No. 11, "Tiger Tank."

Primary Examiner—Melvin B. Feifer  
Attorney, Agent, or Firm—Henry S. Kaplan

[57] CLAIM

The ornamental design for an electronic baseball game casing, substantially as shown.

DESCRIPTION

FIG. 1 is a top perspective view of the electronic baseball game casing showing our new design.

FIG. 2 is a top plan view thereof;

FIG. 3 is a left side elevational view showing the bottom thereof, the right side view being a mirror image of the left side view.

FIG. 4 is a front view thereof;

FIG. 5 is a bottom plan view;

FIG. 6 is a rear elevational view thereof.

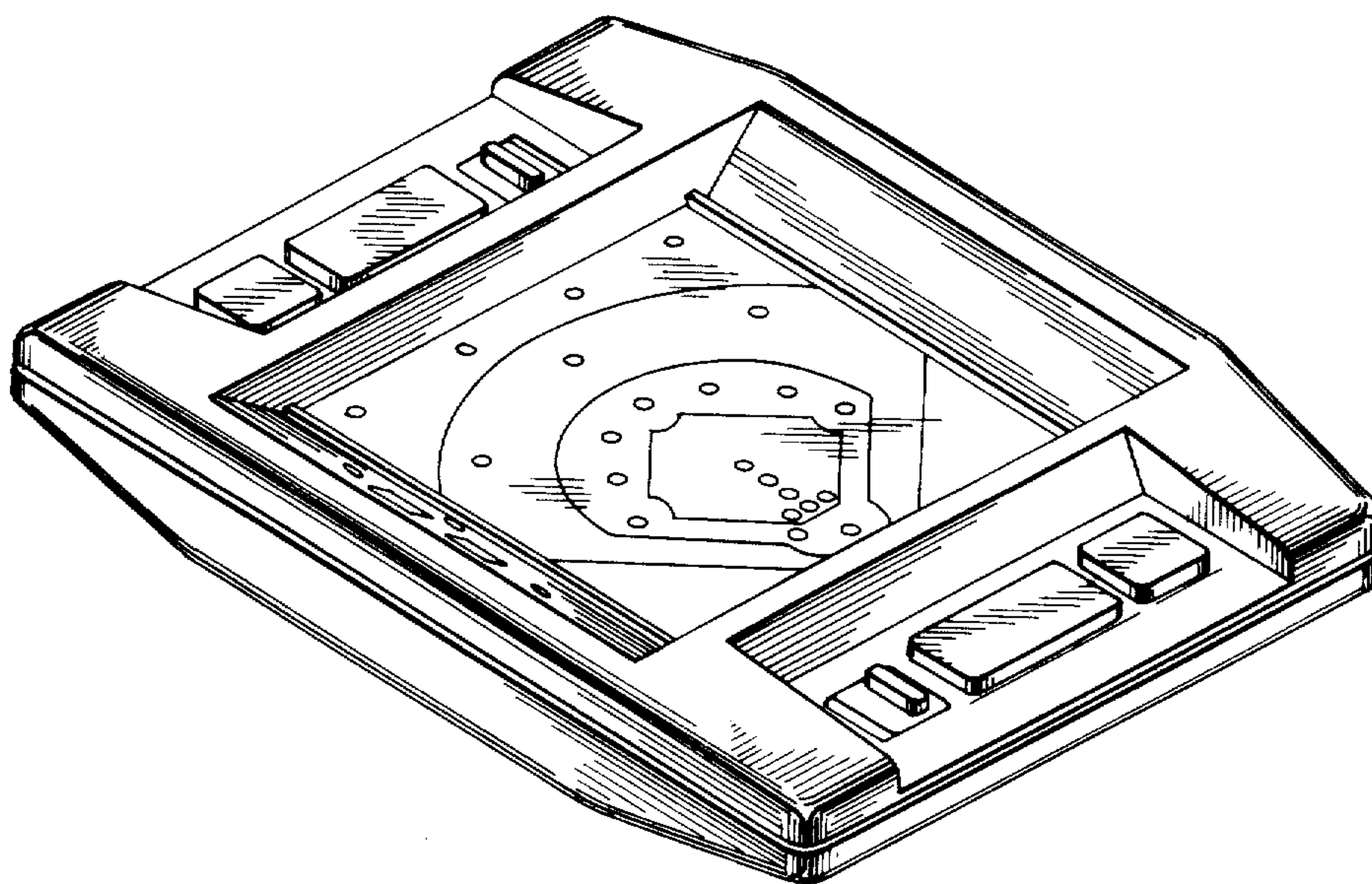

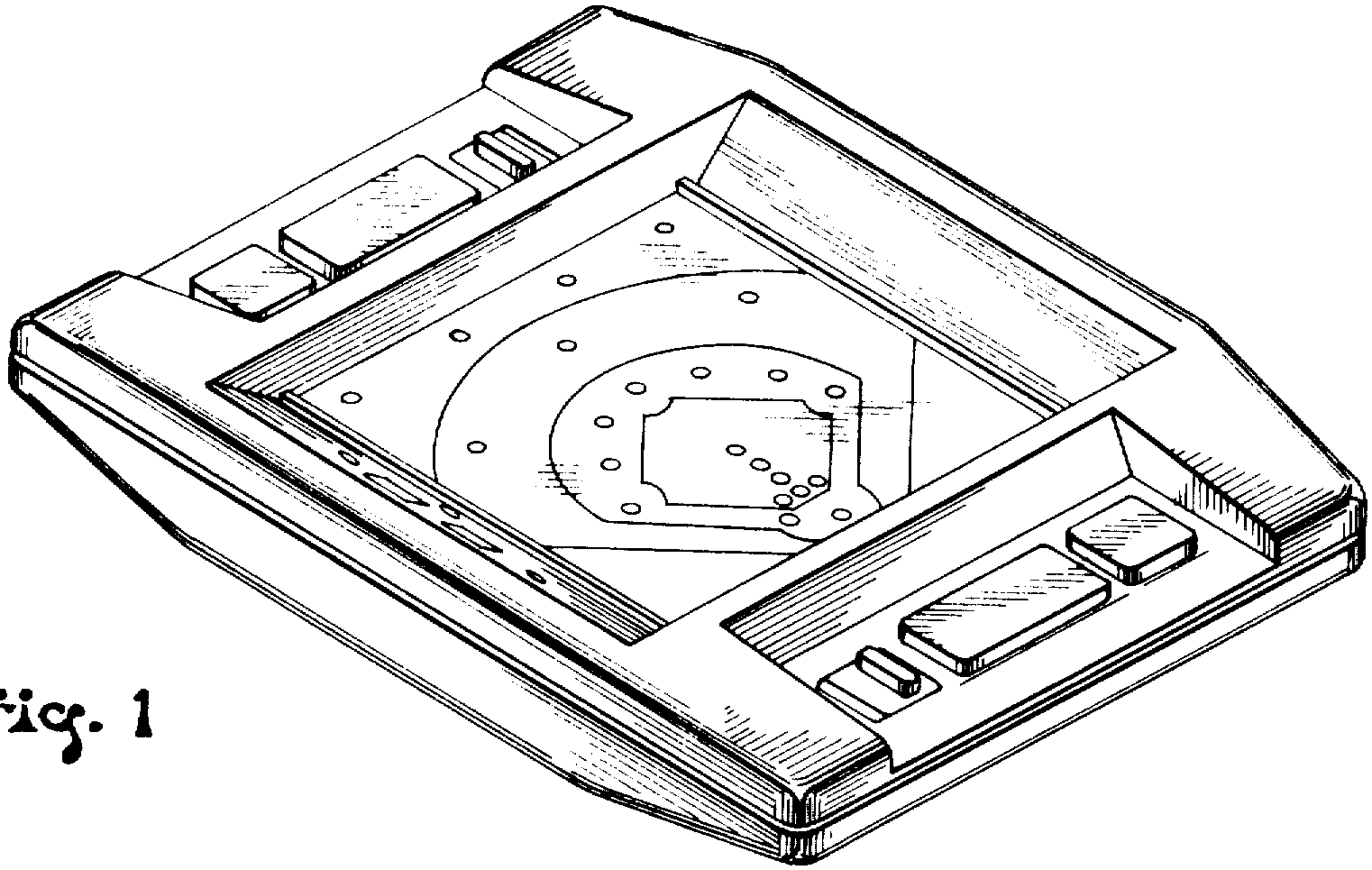

Fig. 1

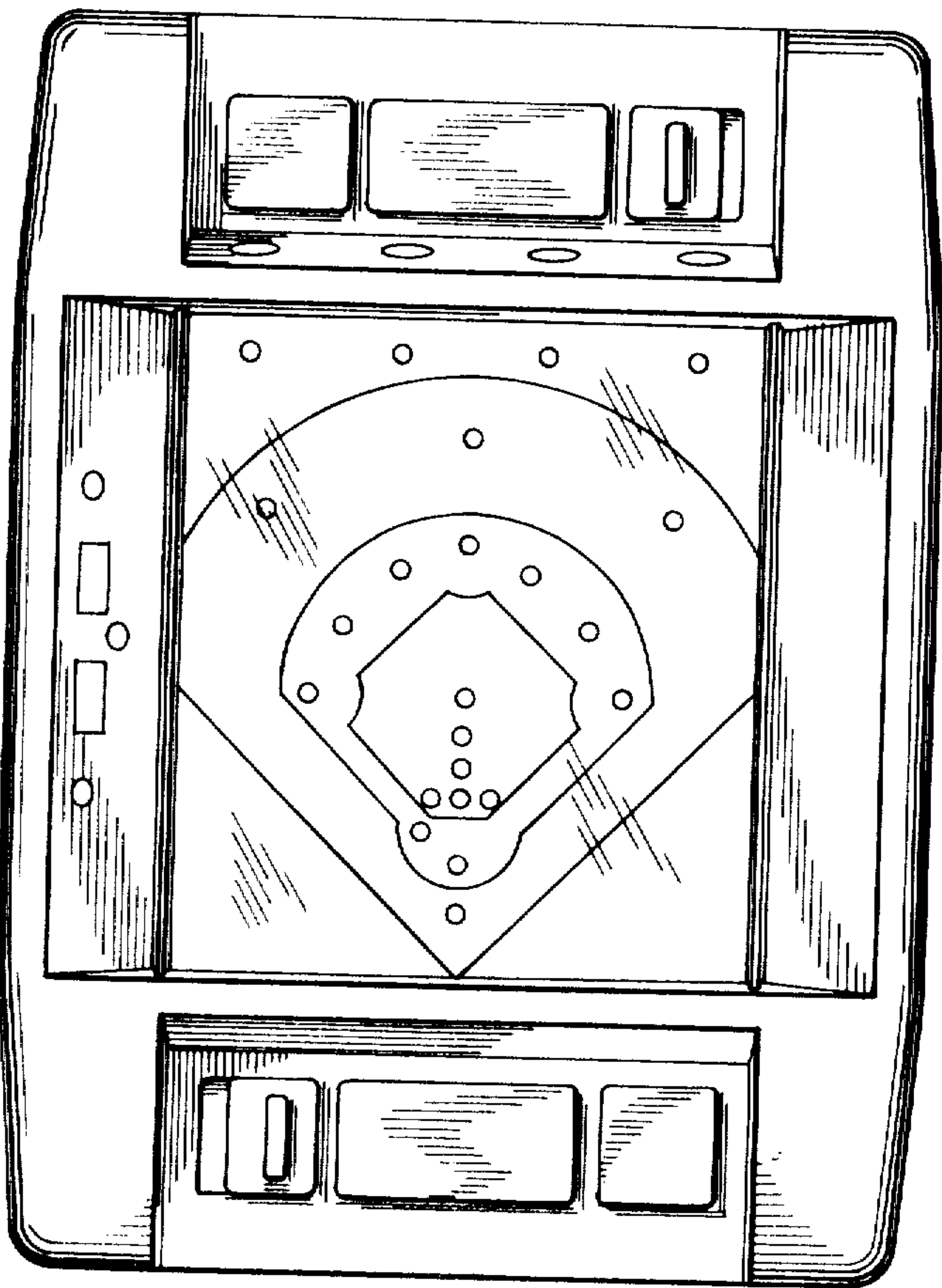

Fig. 2

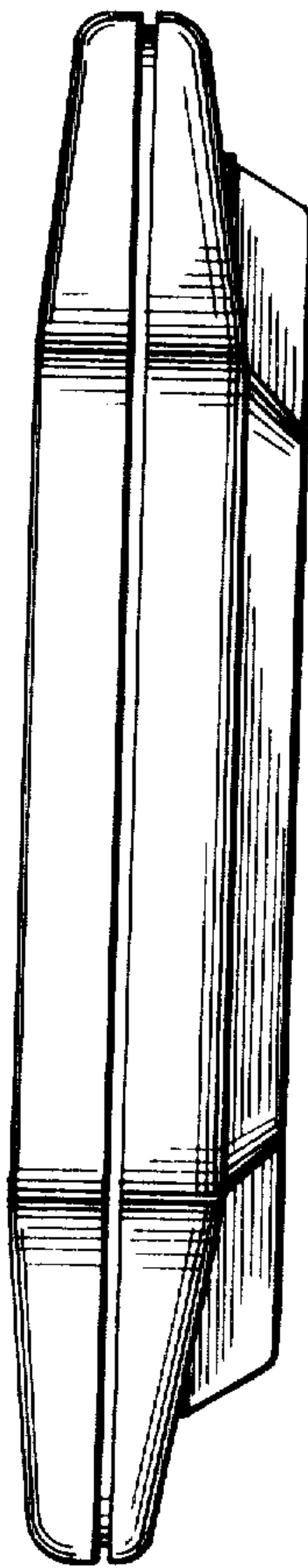

Fig. 3

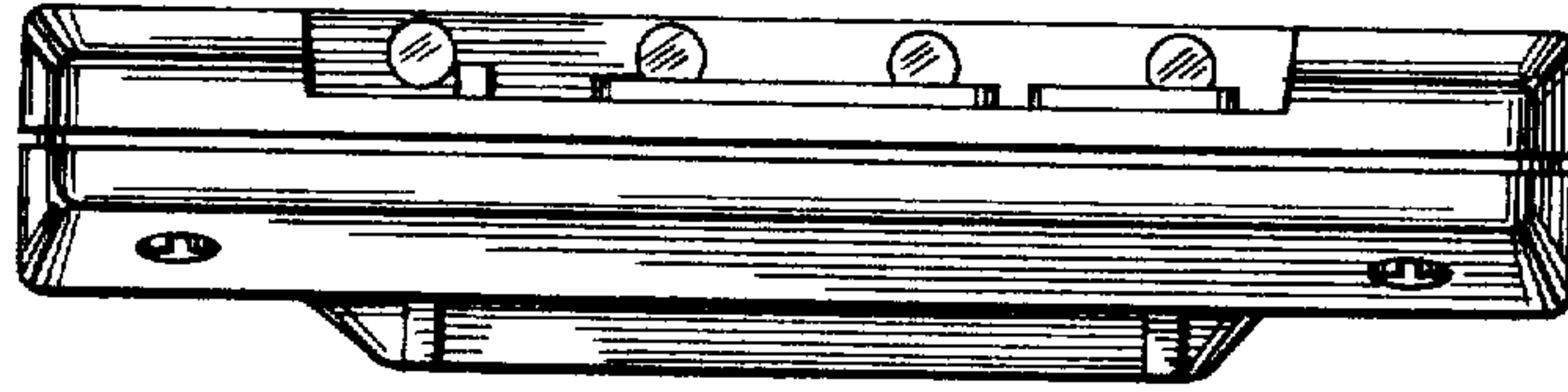

Fig. 4

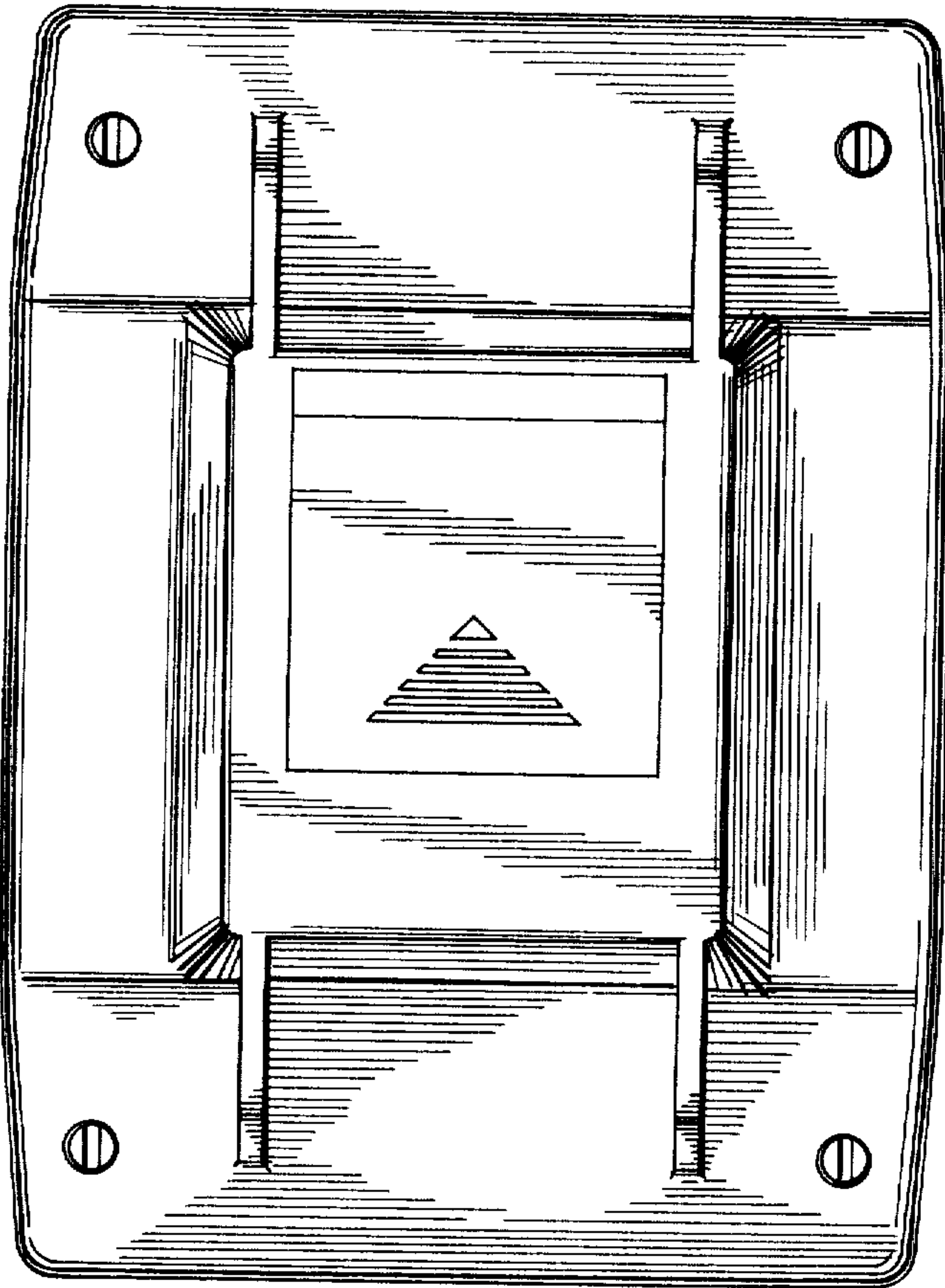

Fig. 5

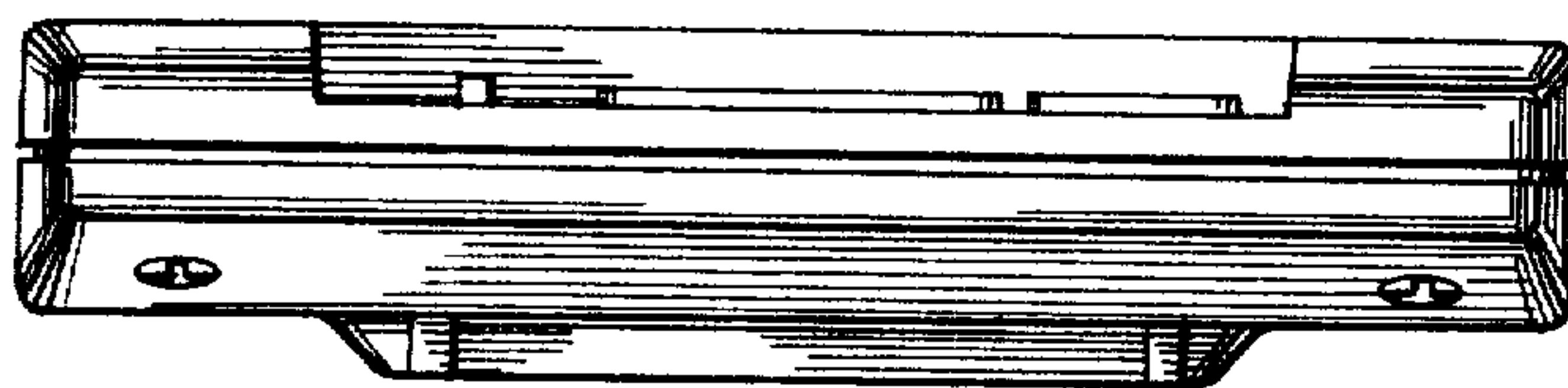

Fig. 6