

[54] TELESCOPIC SIGHT MOUNT FOR 22 CALIBER RIFLE

[76] Inventor: Gerald T. Weast, 20821 Grand River, Detroit, Mich. 48226

[**] Term: 14 Years

[21] Appl. No.: 936,341

[22] Filed: Aug. 24, 1978

[51] Int. Cl. D22-05

[52] U.S. Cl. D22/7

[58] Field of Search 248/205 R; D22/7

[56] References Cited

U.S. PATENT DOCUMENTS

D. 220,483	4/1971	Rubin et al.	D22/7
D. 232,633	9/1974	Weast	D22/7
3,724,800	4/1973	Rubin et al.	248/205 R
3,734,437	5/1973	Underwood	248/205 R

Primary Examiner—A. Hugo Word
Attorney, Agent, or Firm—Charles W. Chandler

[57] CLAIM

The ornamental design for a telescopic sight mount for 22 caliber rifle, as shown and described.

DESCRIPTION

FIG. 1 is a perspective exploded view of a sight mount illustrating my new design;

FIG. 2 is a perspective view of my new design;

FIG. 3 is a view from one end thereof, the opposite end being a mirror image thereof;

FIG. 4 is a view from the right side of FIG. 3, the opposite side being a mirror image thereof;

FIG. 5 is a top view thereof;

FIG. 6 is a bottom view thereof; and

FIG. 7 is a side view of a modified version thereof, the opposite side being a mirror image thereof and both end views looking similar to FIG. 3.

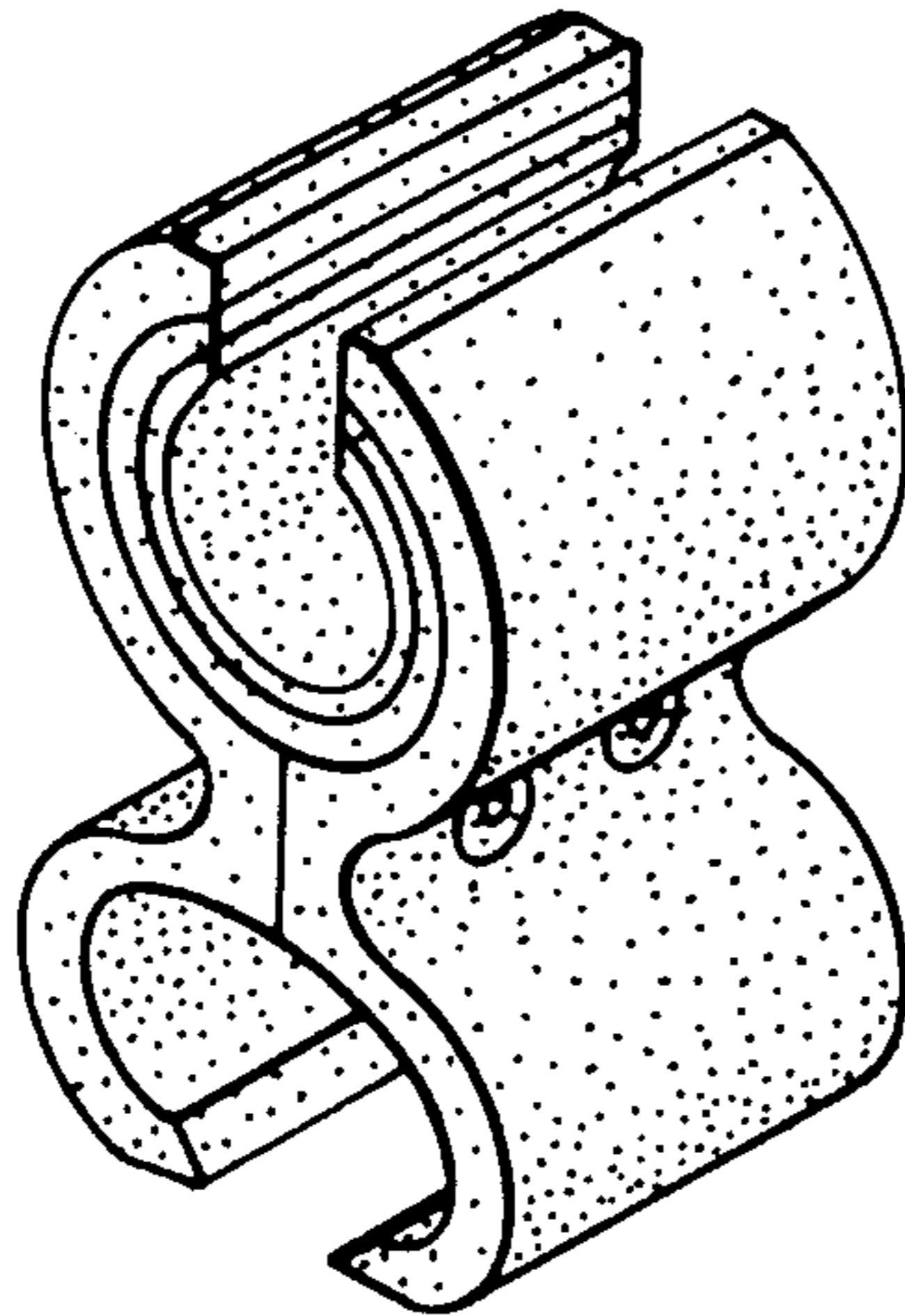

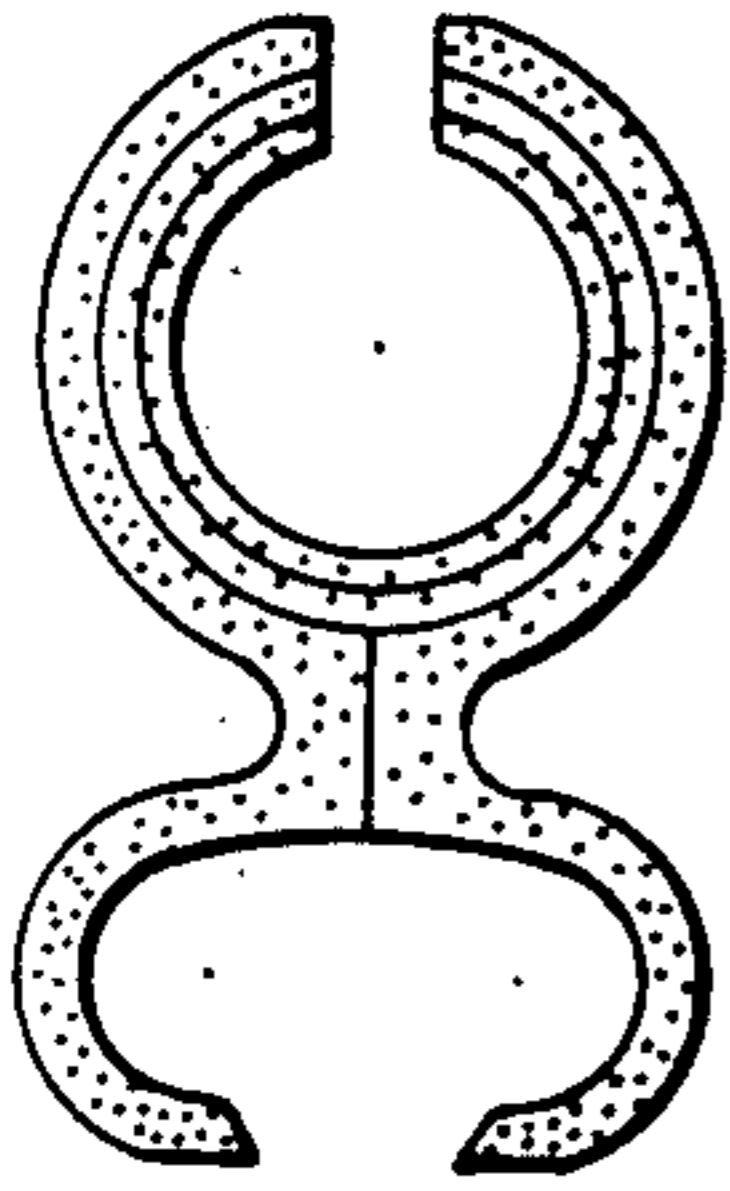
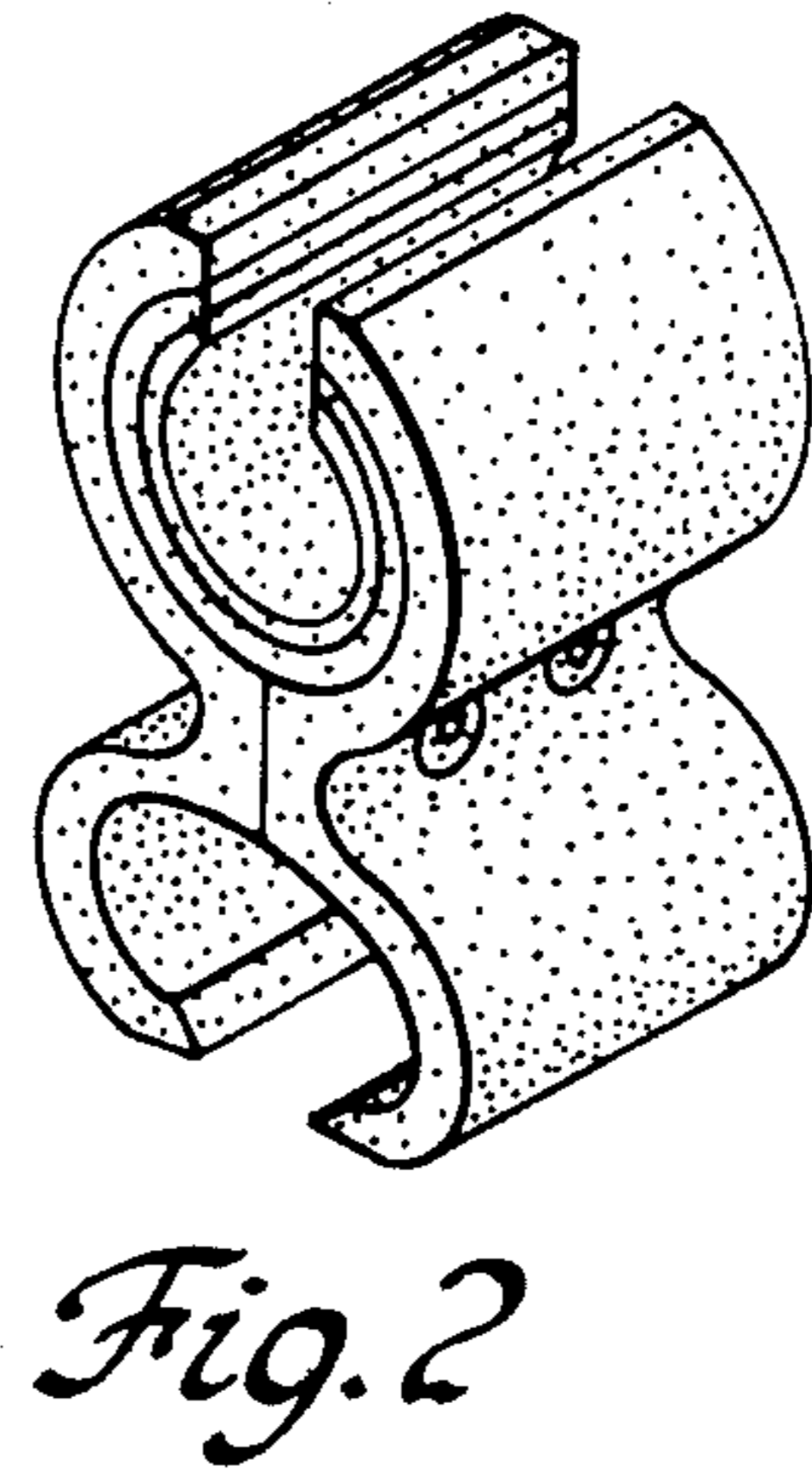
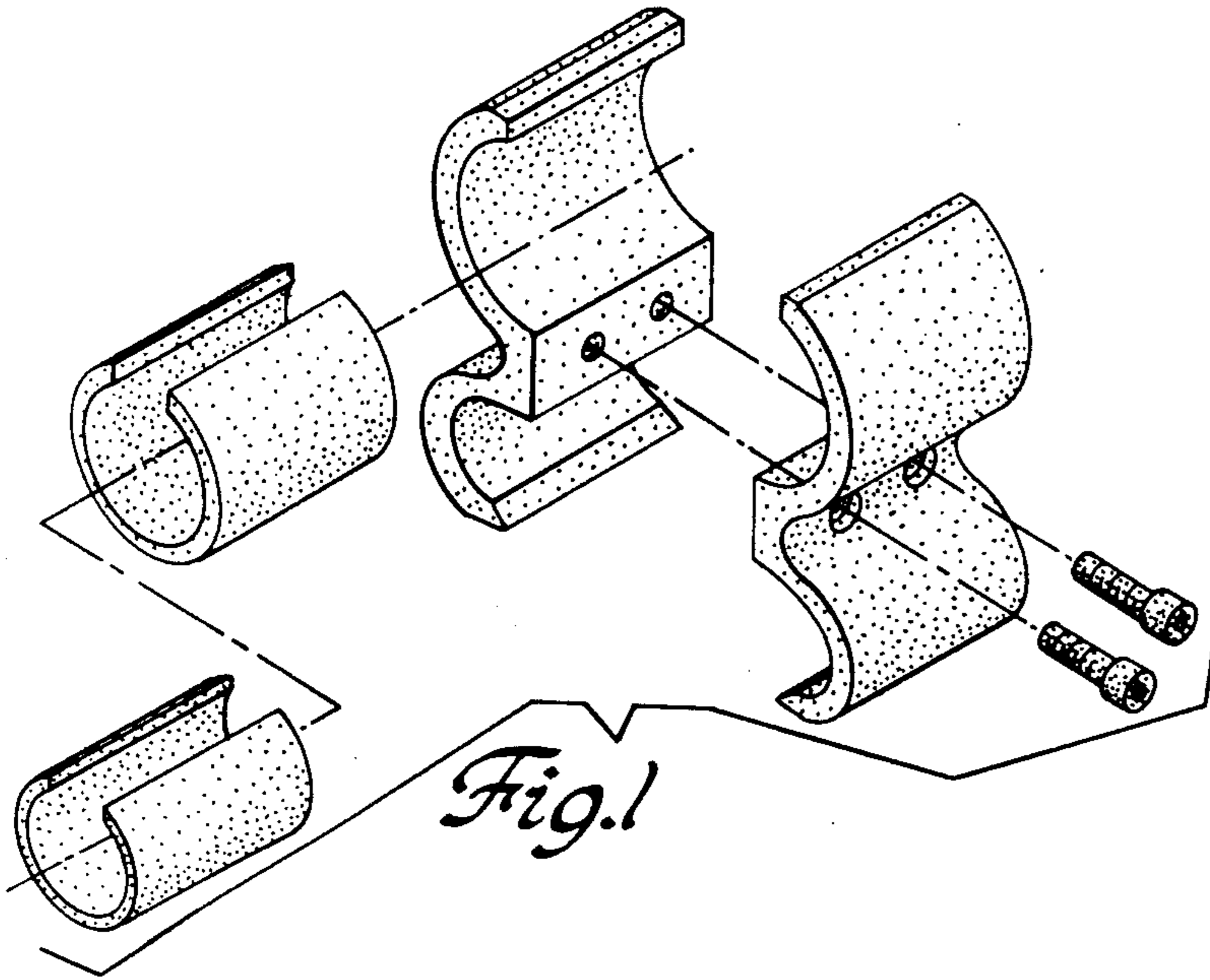

Fig. 3

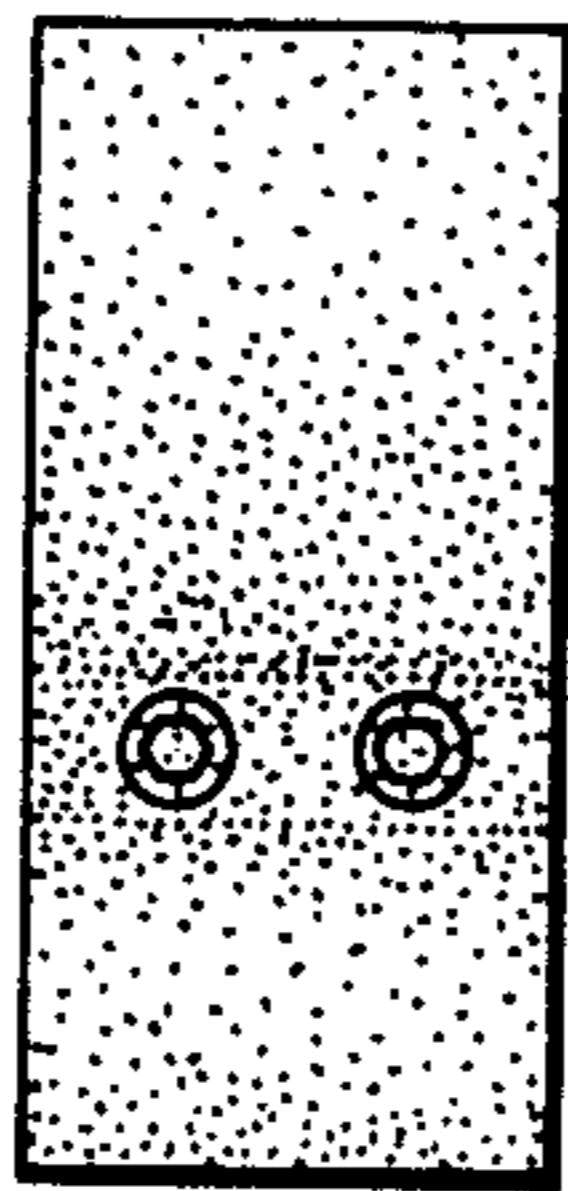

Fig. 4

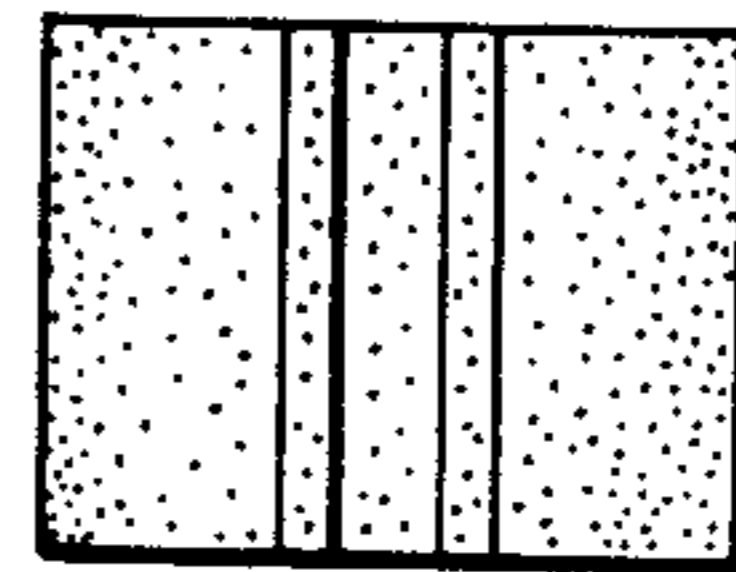

Fig. 5

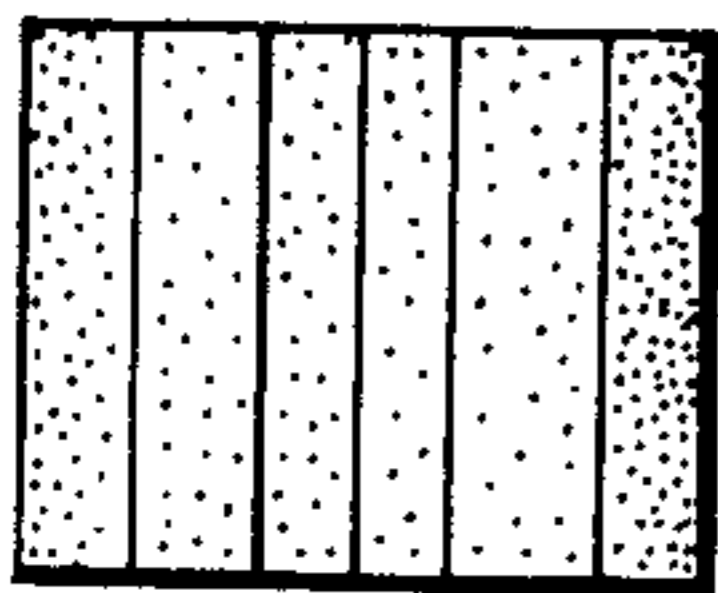

Fig. 6

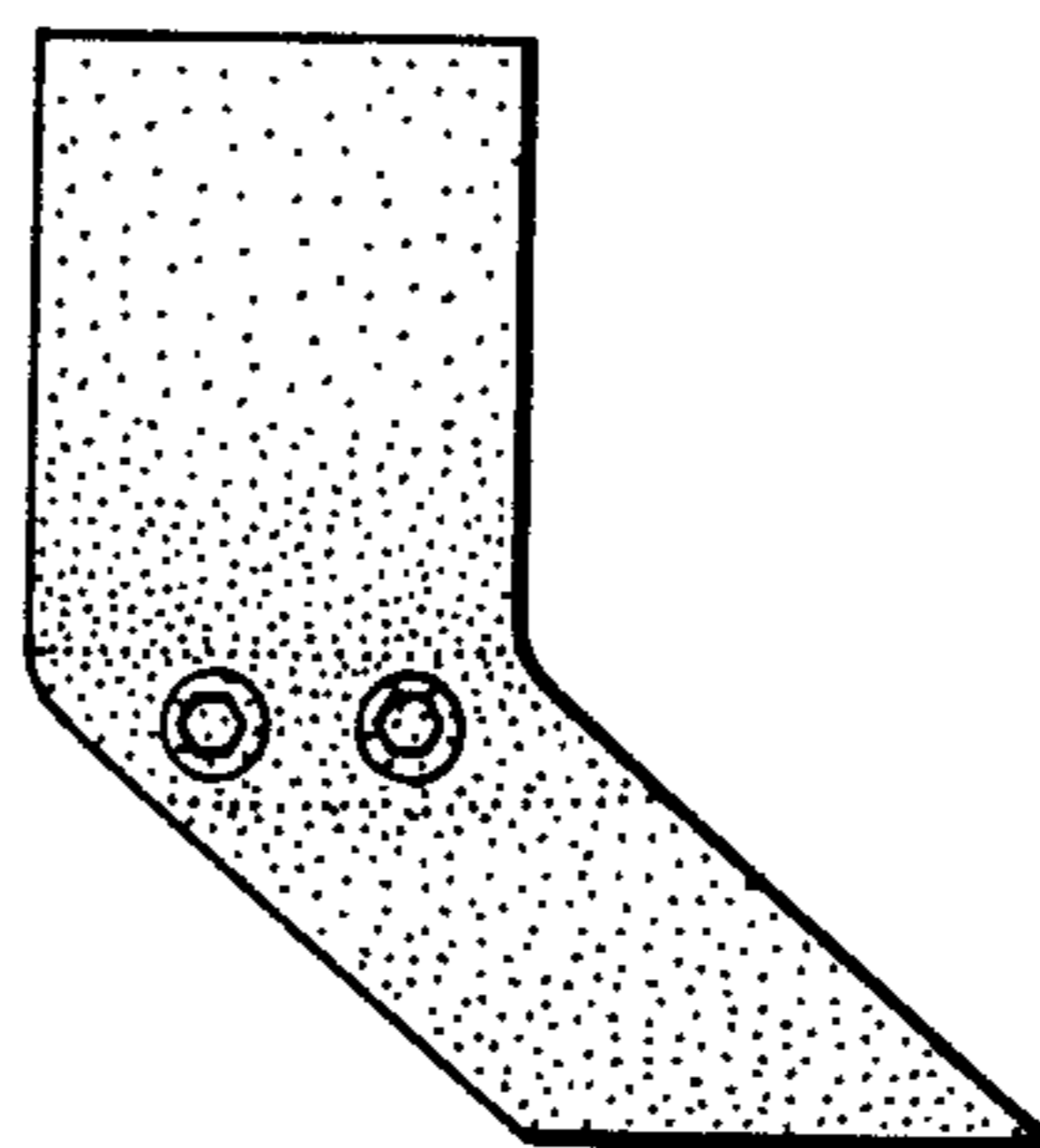

Fig. 7