

[54] TEST TUBE HOLDER

[76] Inventor: Louise I. Oliver, 538 W. 79th St., Los Angeles, Calif. 90044

[**] Term: 14 Years

[21] Appl. No.: 11,532

[22] Filed: Feb. 12, 1979

[51] Int. Cl. D24-02; D24-99

[52] U.S. Cl. D24/32; D11/147; D6/125

[58] Field of Search D11/147; 211/74, 71, 211/69, 73; D24/32; D6/125, 137

[56] References Cited

U.S. PATENT DOCUMENTS

D. 190,506	6/1961	Saks et al.	D11/147
D. 200,965	4/1965	Erbguth	D11/147
D. 204,258	4/1966	Barrantes et al.	D24/32

D. 231,734	6/1974	Sendra et al.	D24/32
3,674,198	7/1972	Eberle	211/74
3,727,771	4/1973	Hoffman	211/69
4,068,798	1/1978	Rohde	211/74 X

Primary Examiner—Bernard Ansher
Attorney, Agent, or Firm—Ralph B. Pastoriza

[57] CLAIM

The ornamental design for a test tube holder, substantially as shown.

DESCRIPTION

FIG. 1 is an exploded perspective view of a test tube holder showing my new design; FIG. 2 is a perspective view of the elements of FIG. 1 in assembled relationship; FIG. 3 is a side elevational view thereof; FIG. 4 is a cross section looking in the direction of the arrows 4-4 of FIG. 2 thereof; FIG. 5 is a bottom plan view thereof; and FIG. 6 is a top plan view thereof.

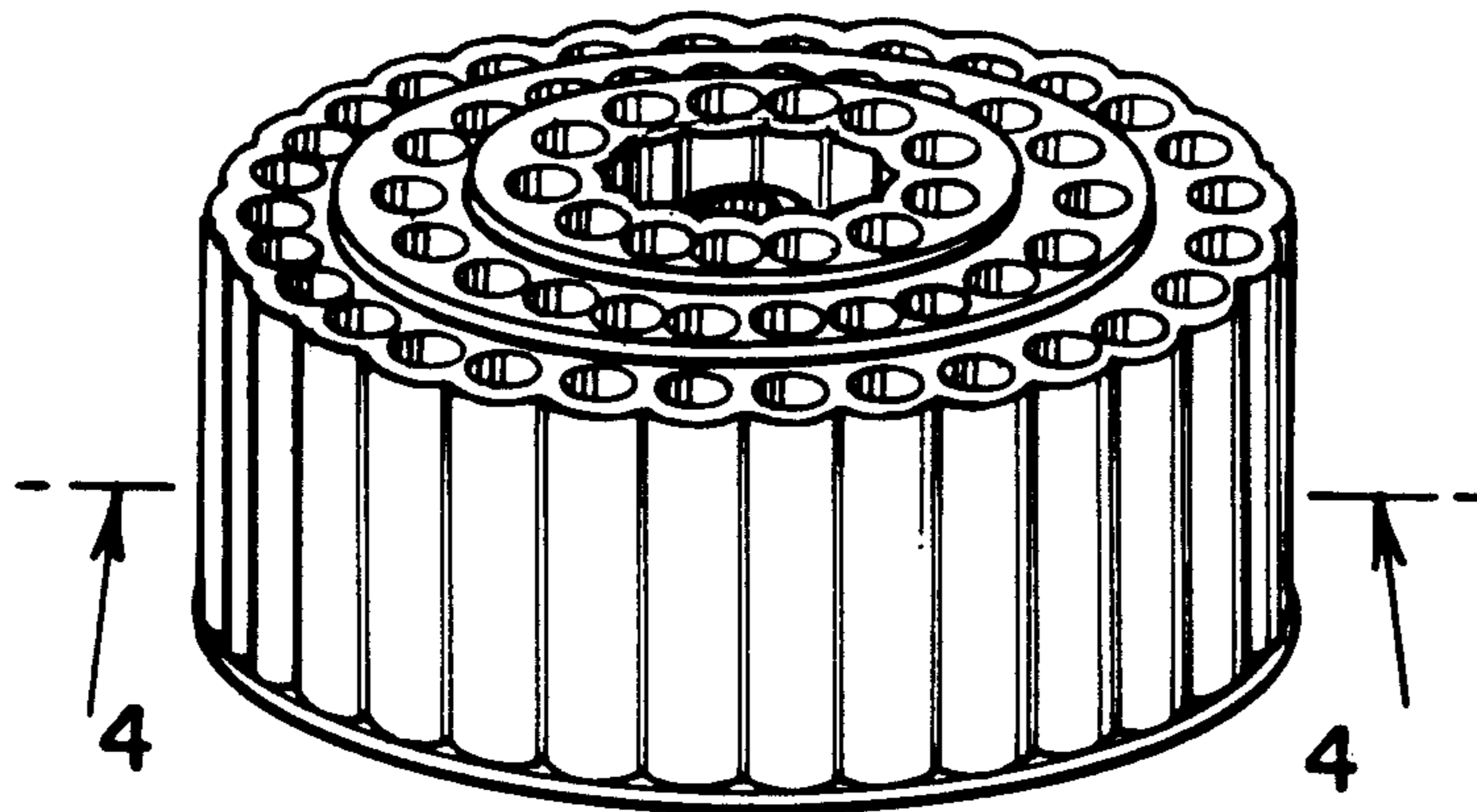

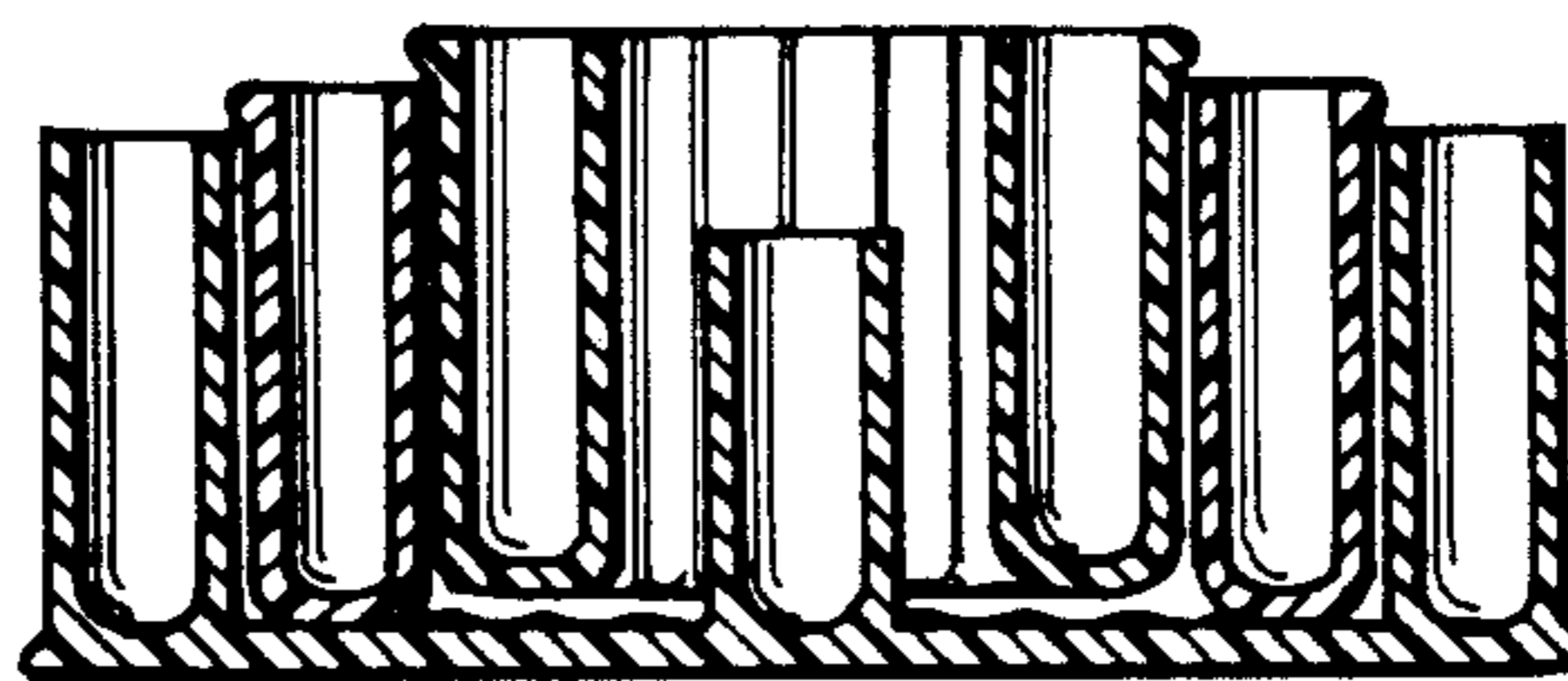
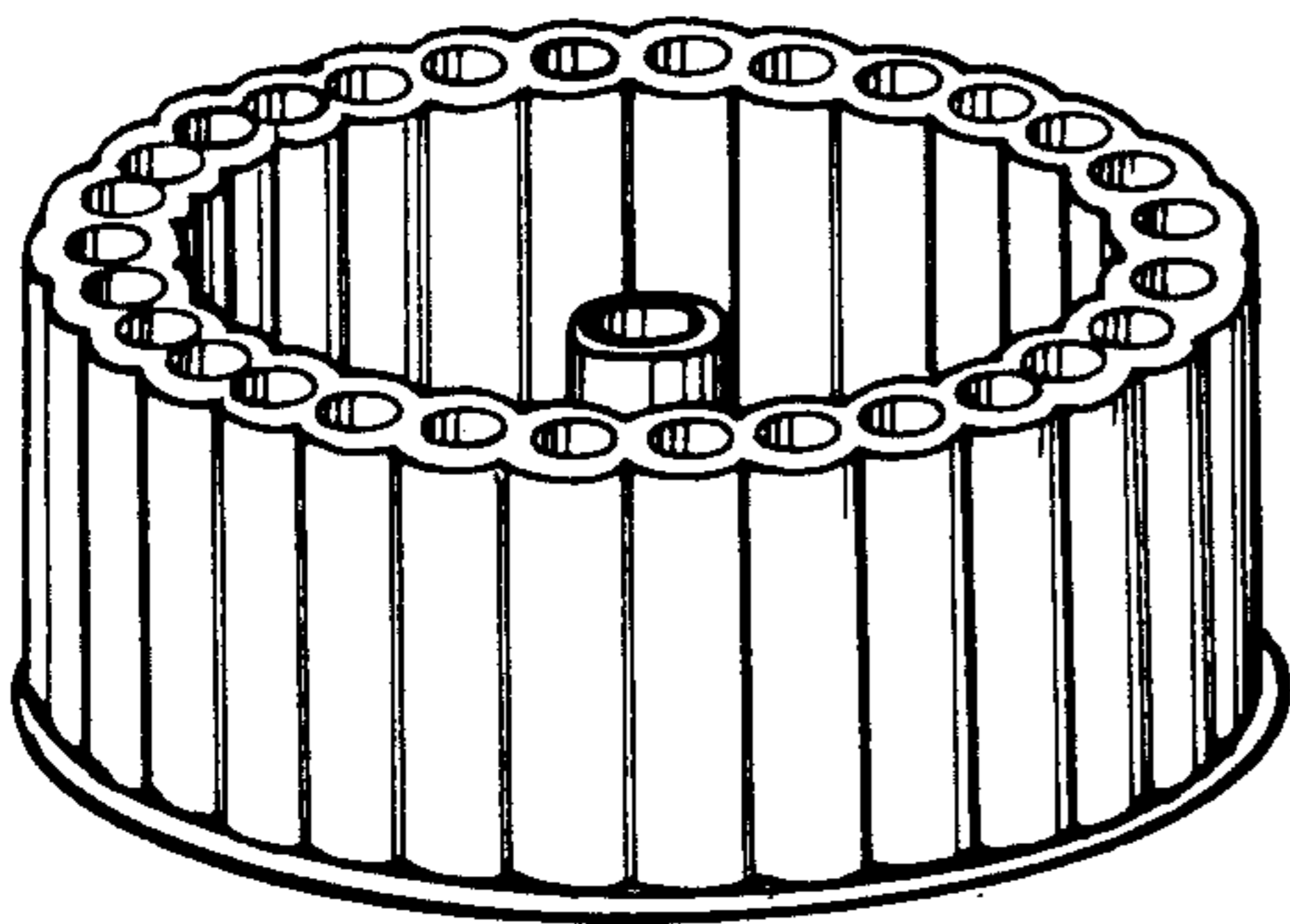
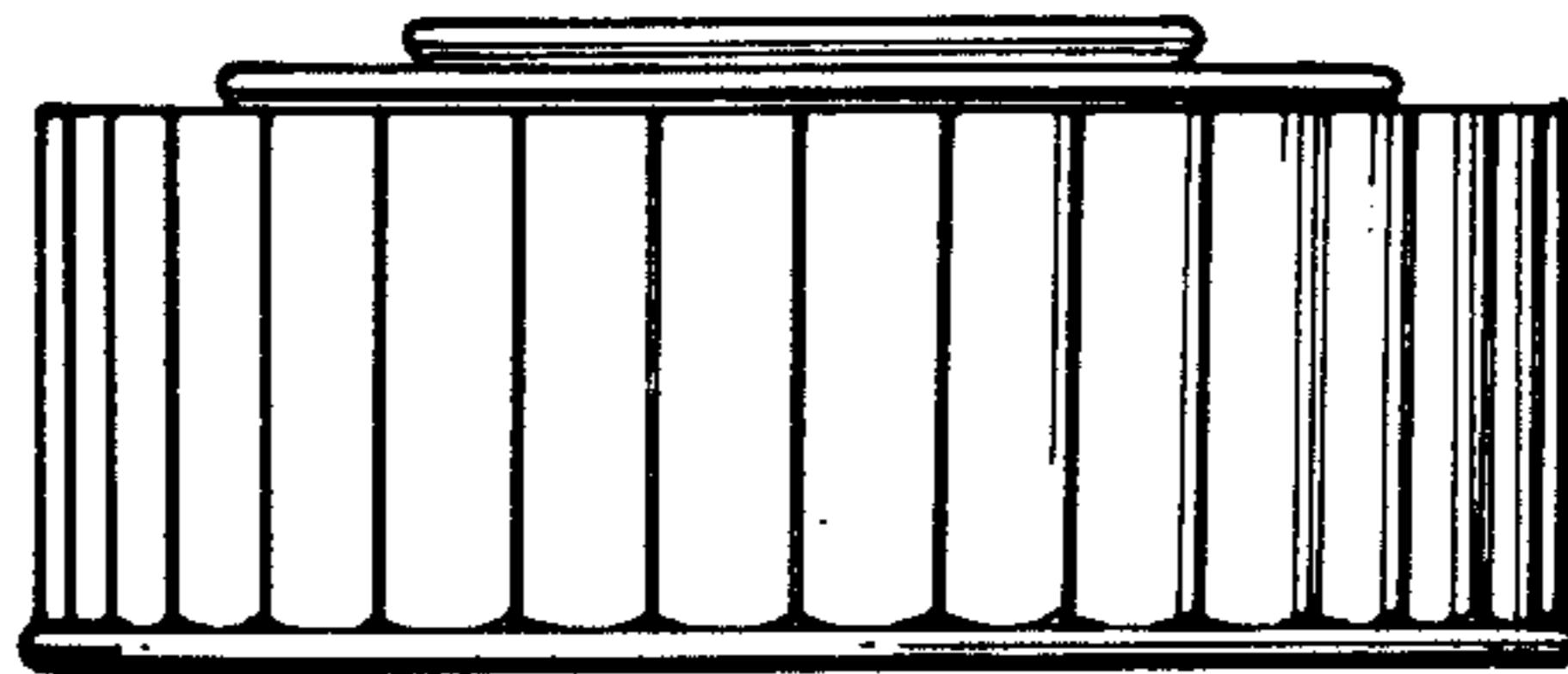
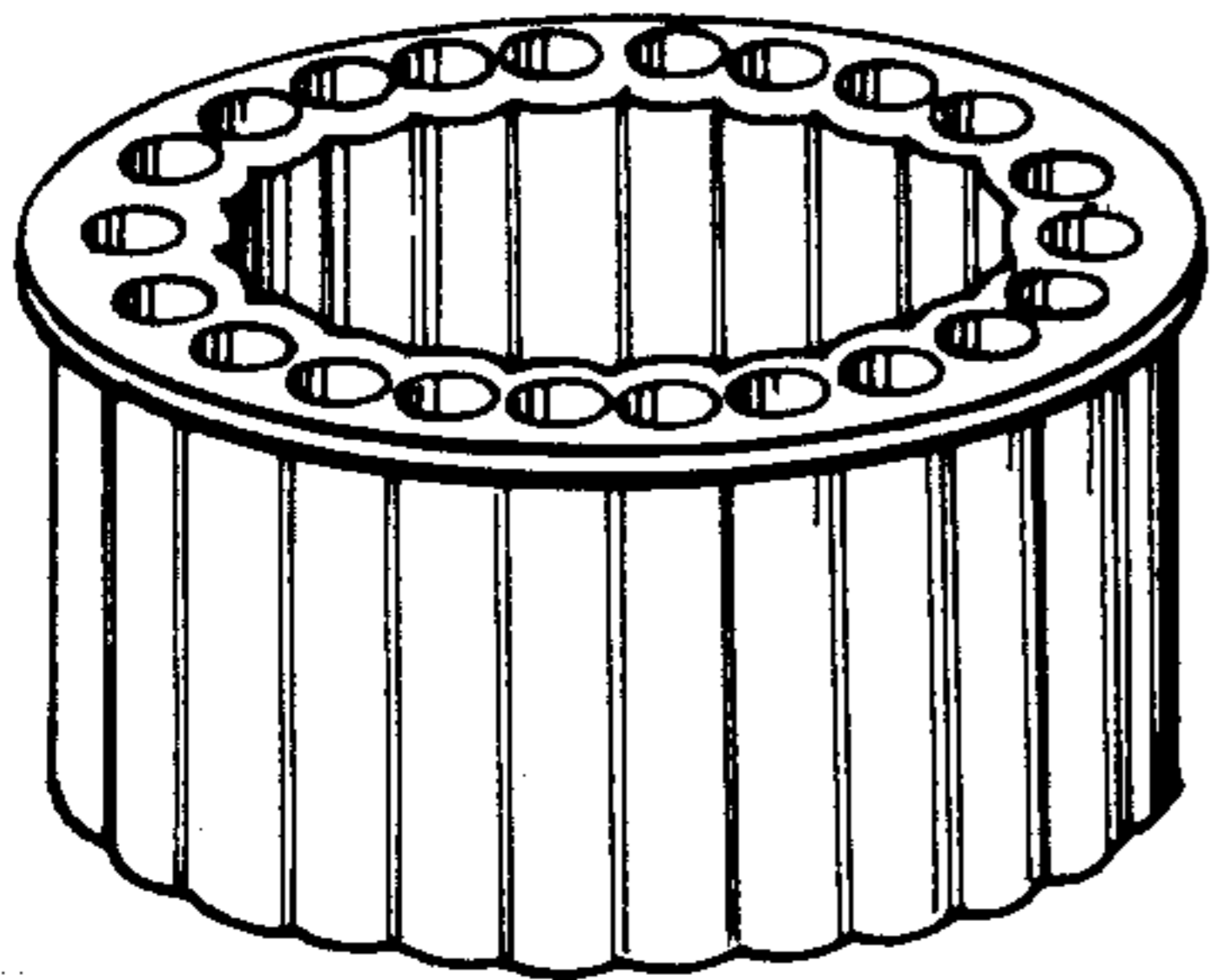
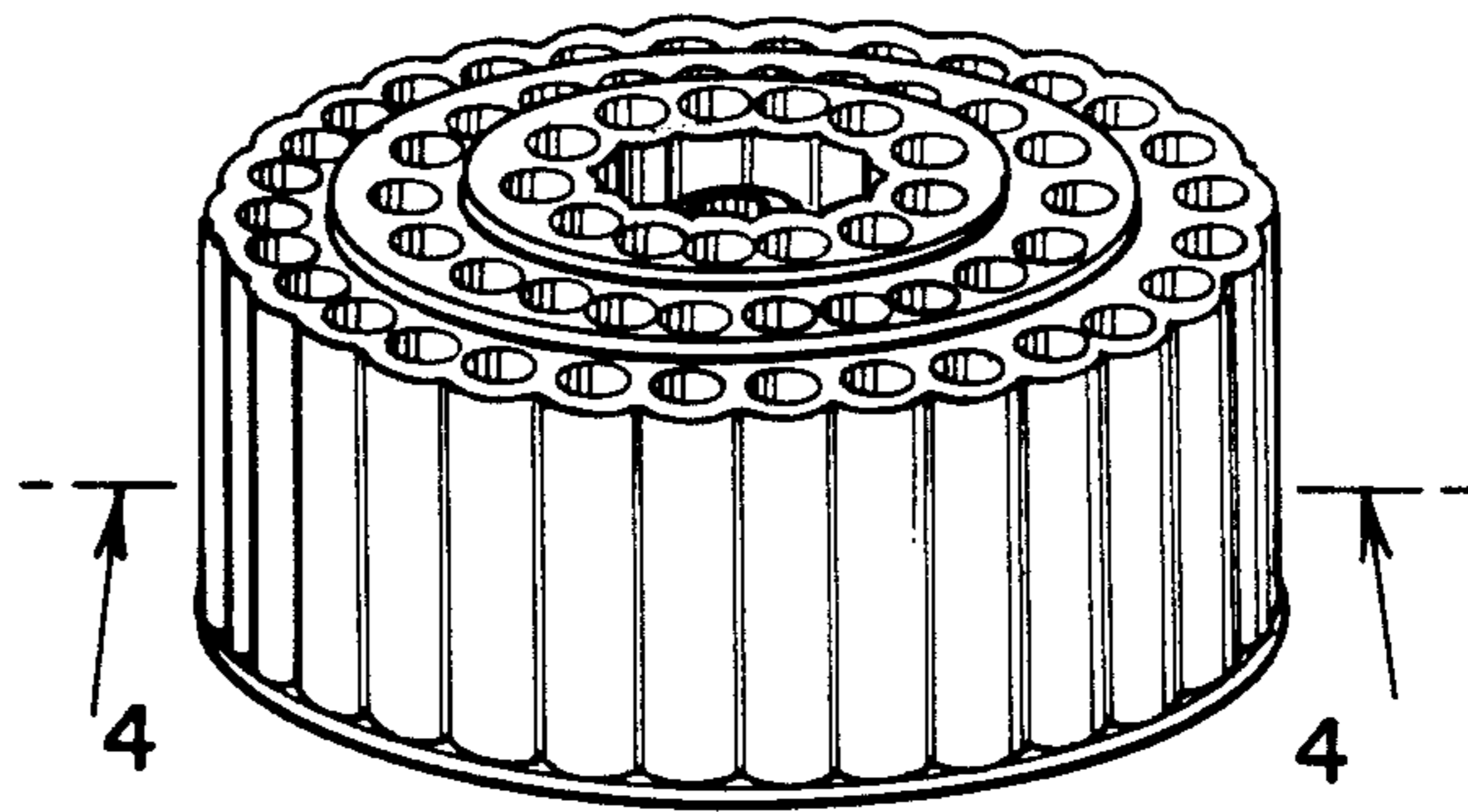
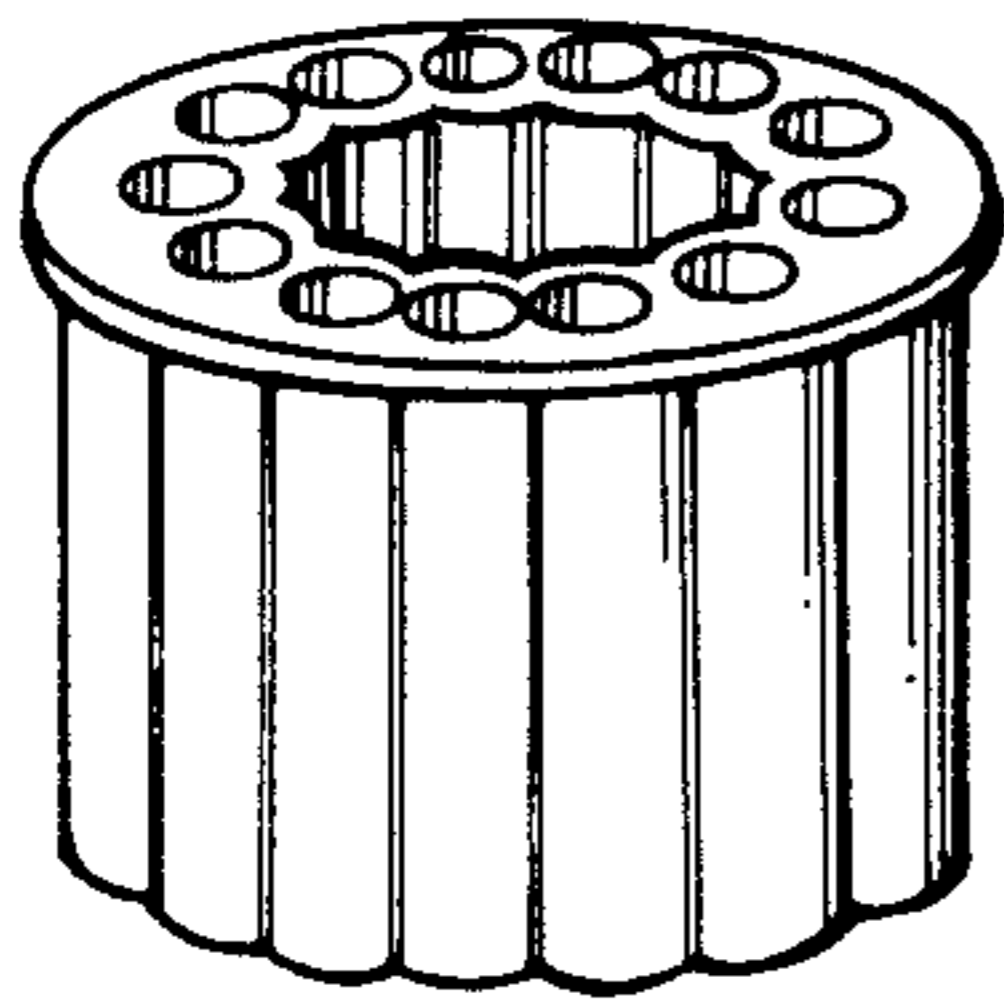

FIG. 1

FIG. 2

FIG. 3

FIG. 4

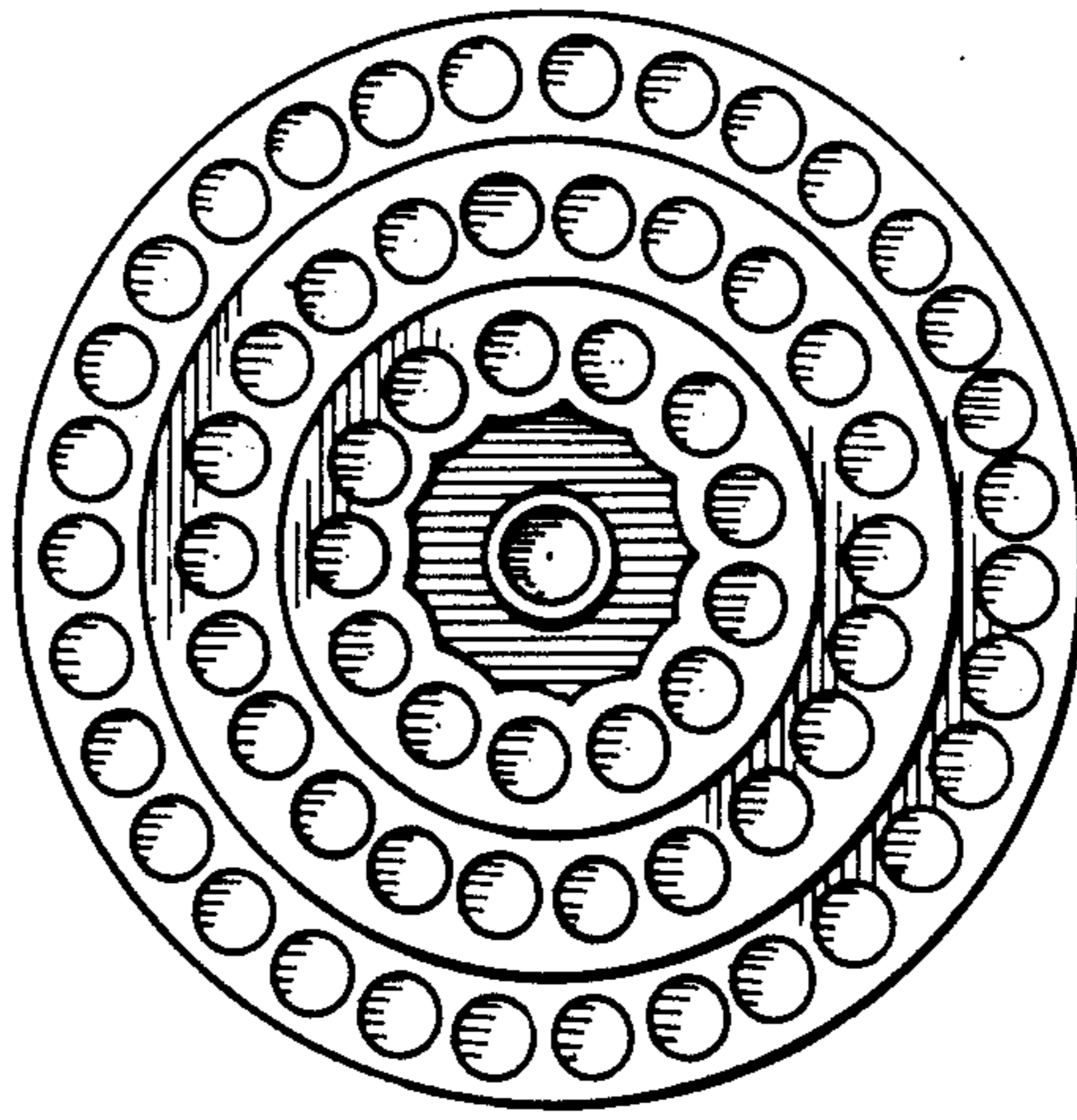
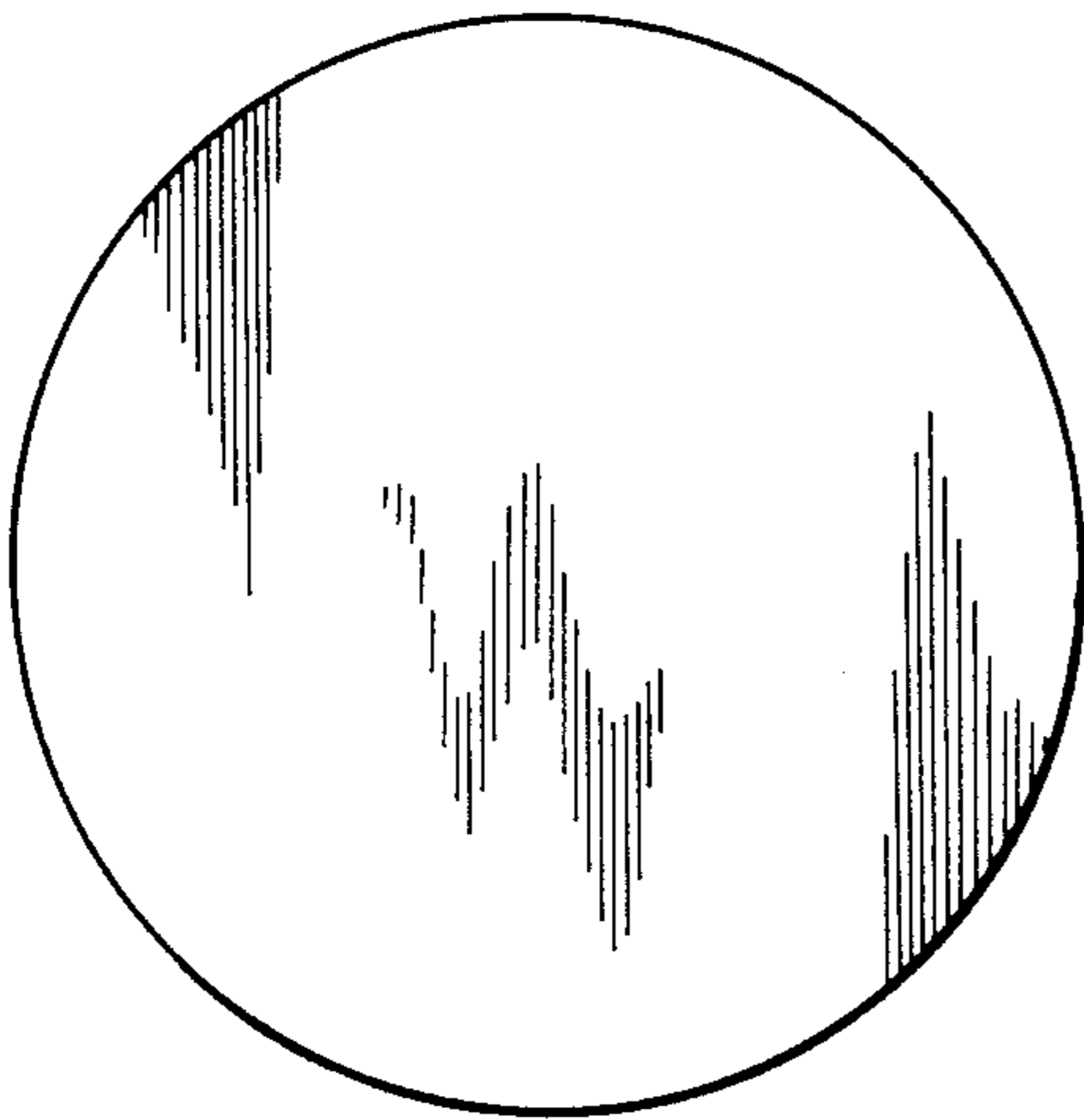

FIG. 5

FIG. 6