

[54] BOTTLE CARRIER

3,531,014	9/1970	Lane	206/203
4,040,517	8/1977	Torokvei	206/203 X
4,204,596	5/1980	Davis	206/203

[76] Inventor: Frank E. Davis, 3103 Westador Dr., Arlington, Tex. 76015

Primary Examiner—Robert C. Spangler  
Attorney, Agent, or Firm—Charles W. McHugh

[\*\*] Term: 14 Years

[21] Appl. No.: 4,688

[57] CLAIM

[22] Filed: Jan. 19, 1979

The ornamental design for a bottle carrier, as shown.

[51] Int. Cl. D9—03

[52] U.S. Cl. D99/48; D9/341

[58] Field of Search D9/176-179,  
D9/246-248; 220/DIG. 2; 206/139, 162, 201,  
203

DESCRIPTION

FIG. 1 is a perspective view of a bottle carrier showing my new design;

FIG. 2 is a top view thereof;

FIG. 3 is an end view thereof;

FIG. 4 is a sectional elevation view, taken from one end of the bottle carrier, along line 4—4 in FIG. 2;

FIG. 5 is a bottom view thereof;

FIG. 6 is a side elevational view thereof; and

FIG. 7 is a sectioned elevational view taken in the plane 7—7 in FIG. 2.

[56] References Cited

U.S. PATENT DOCUMENTS

D. 209,624	12/1967	Hirota	D9/177
D. 216,676	3/1970	Currie	D9/176

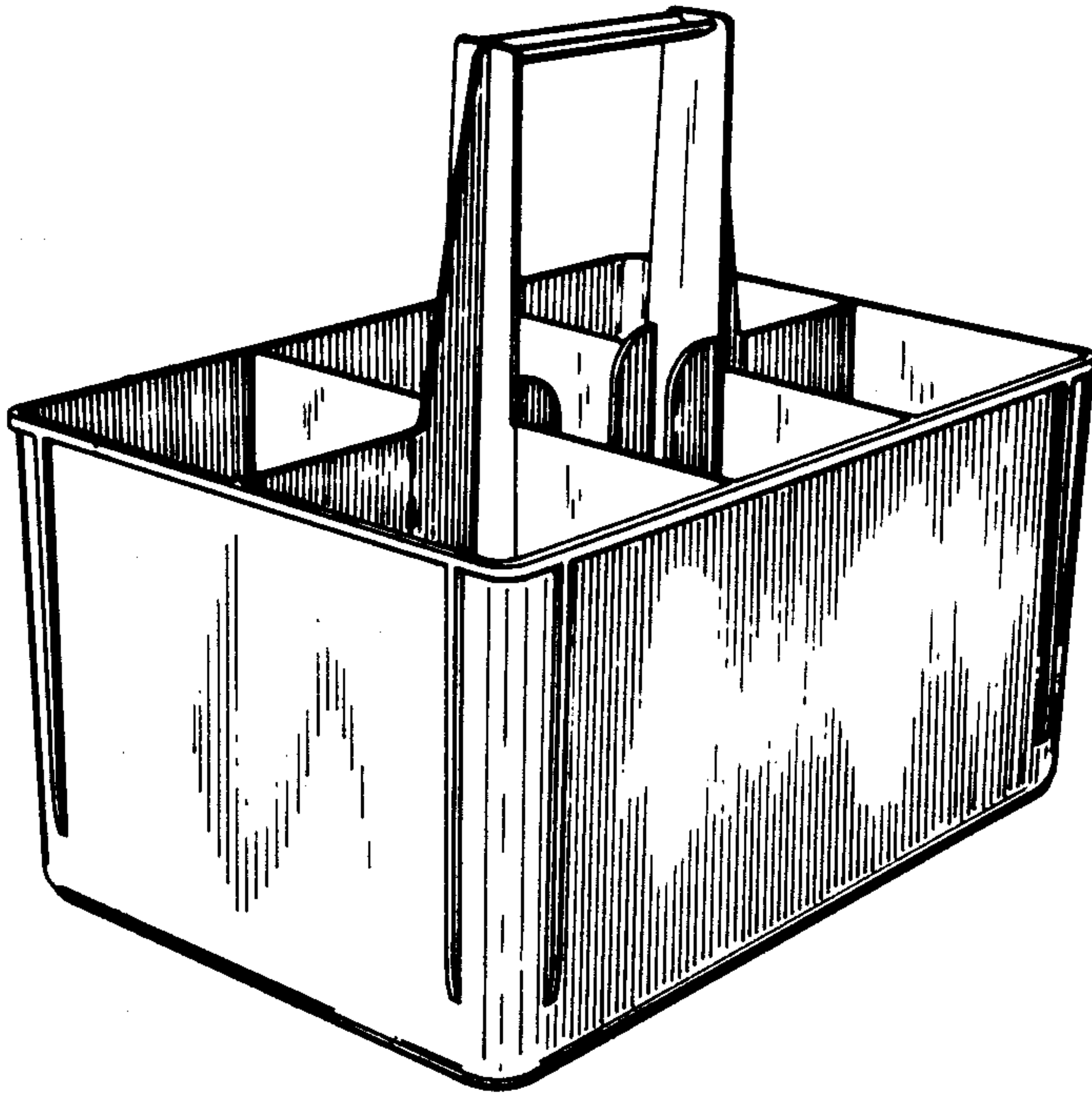

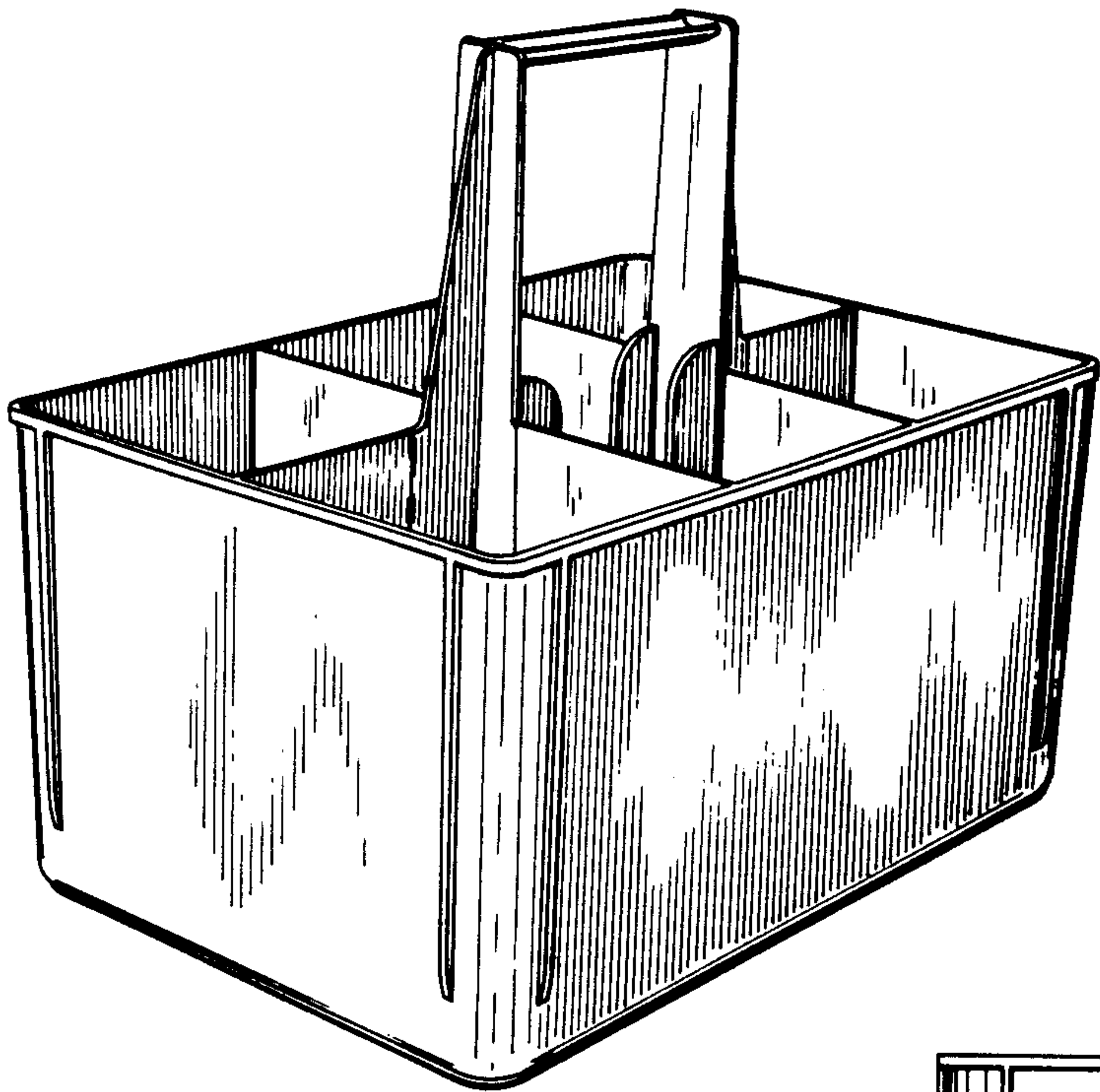

FIG. 1

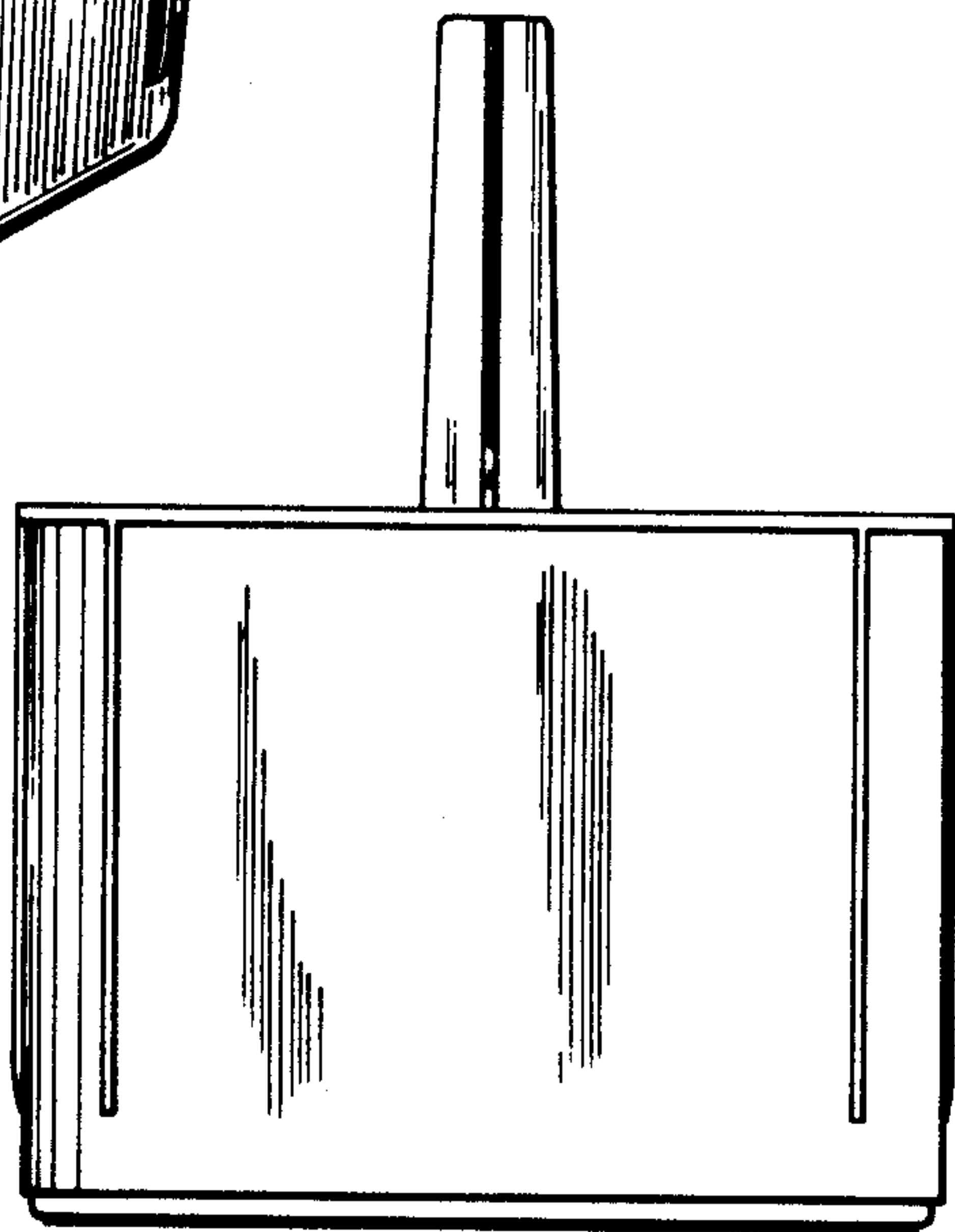

FIG. 3

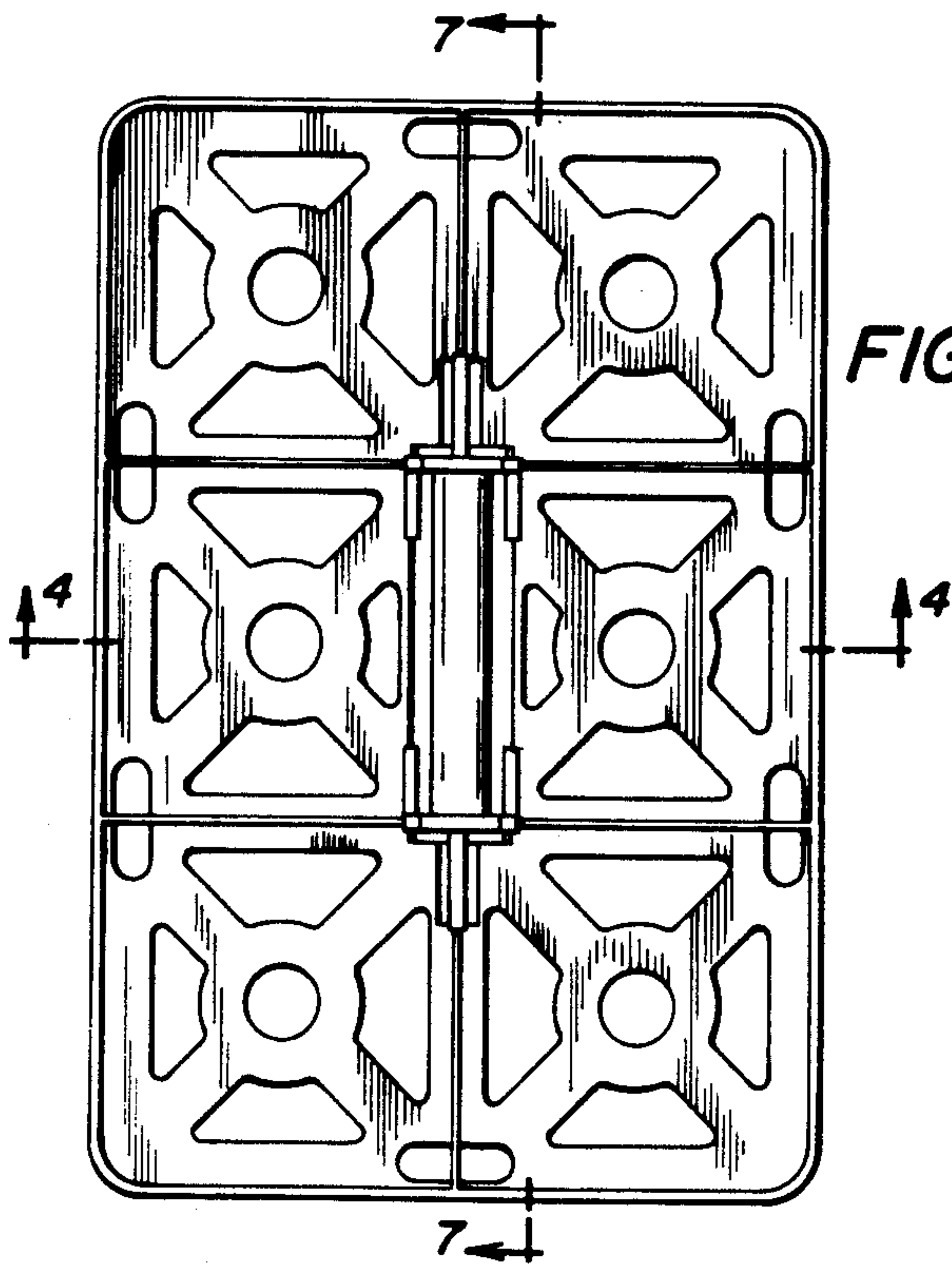

FIG. 2

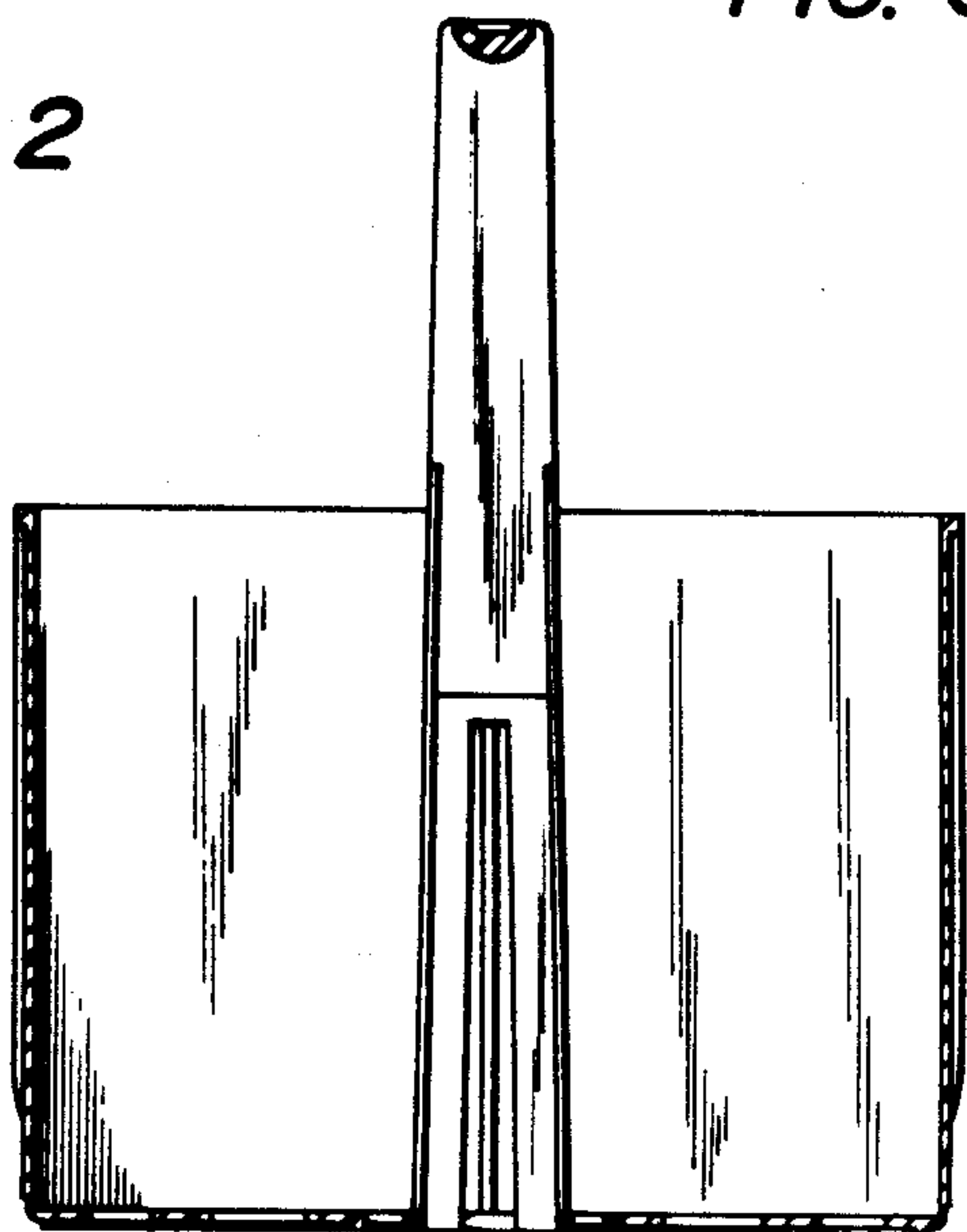
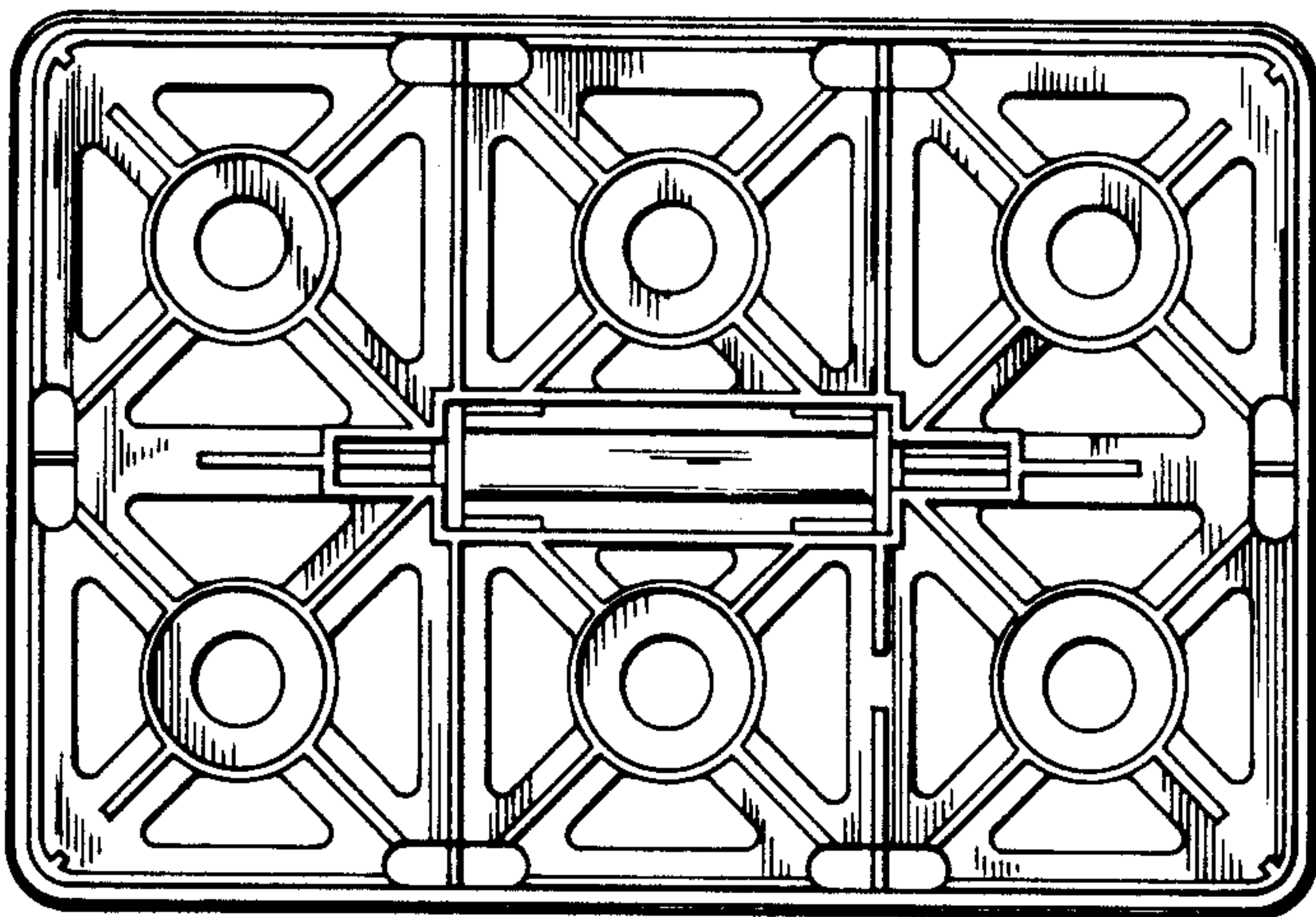
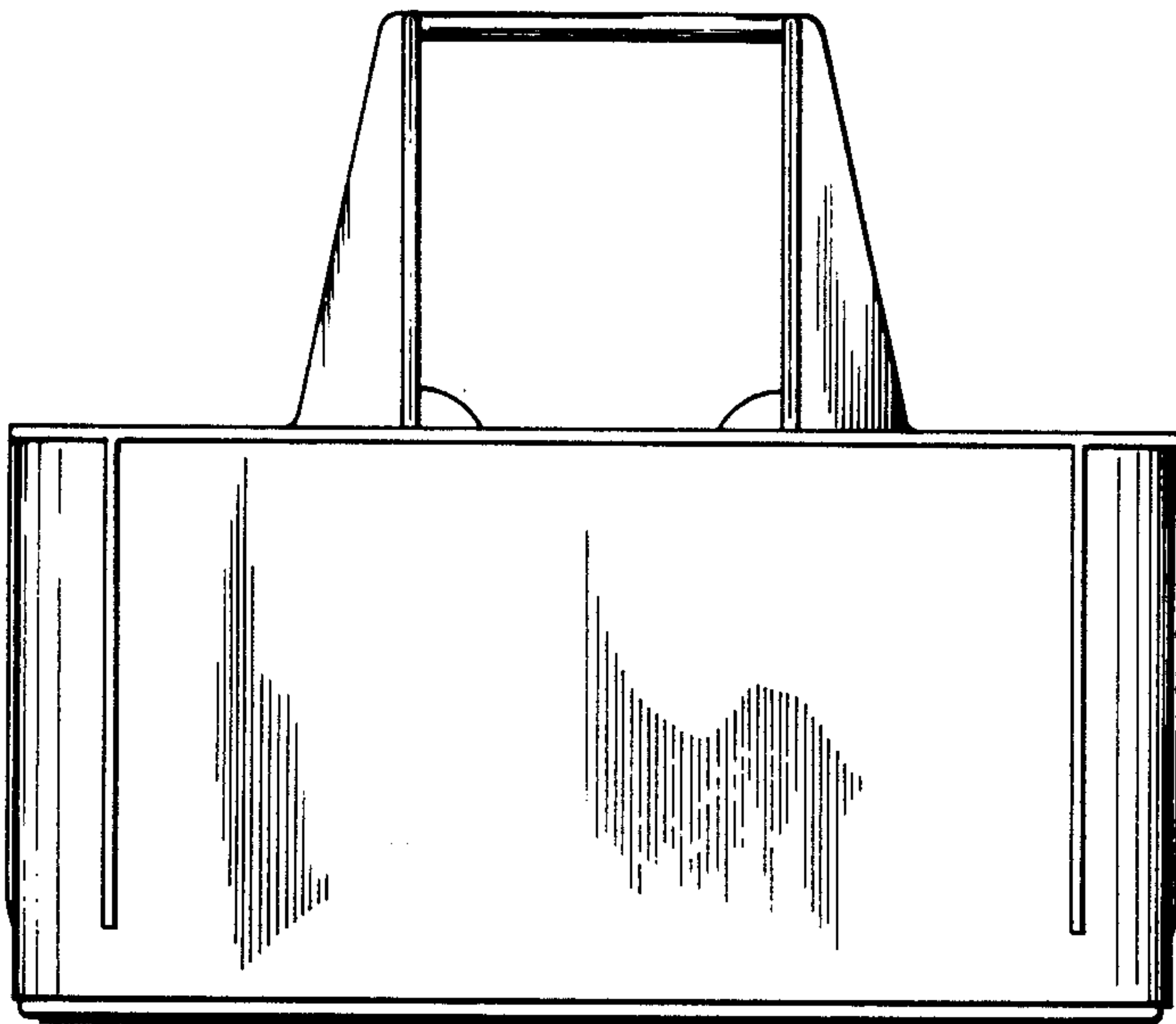

FIG. 4



*FIG. 5*



*FIG. 6*

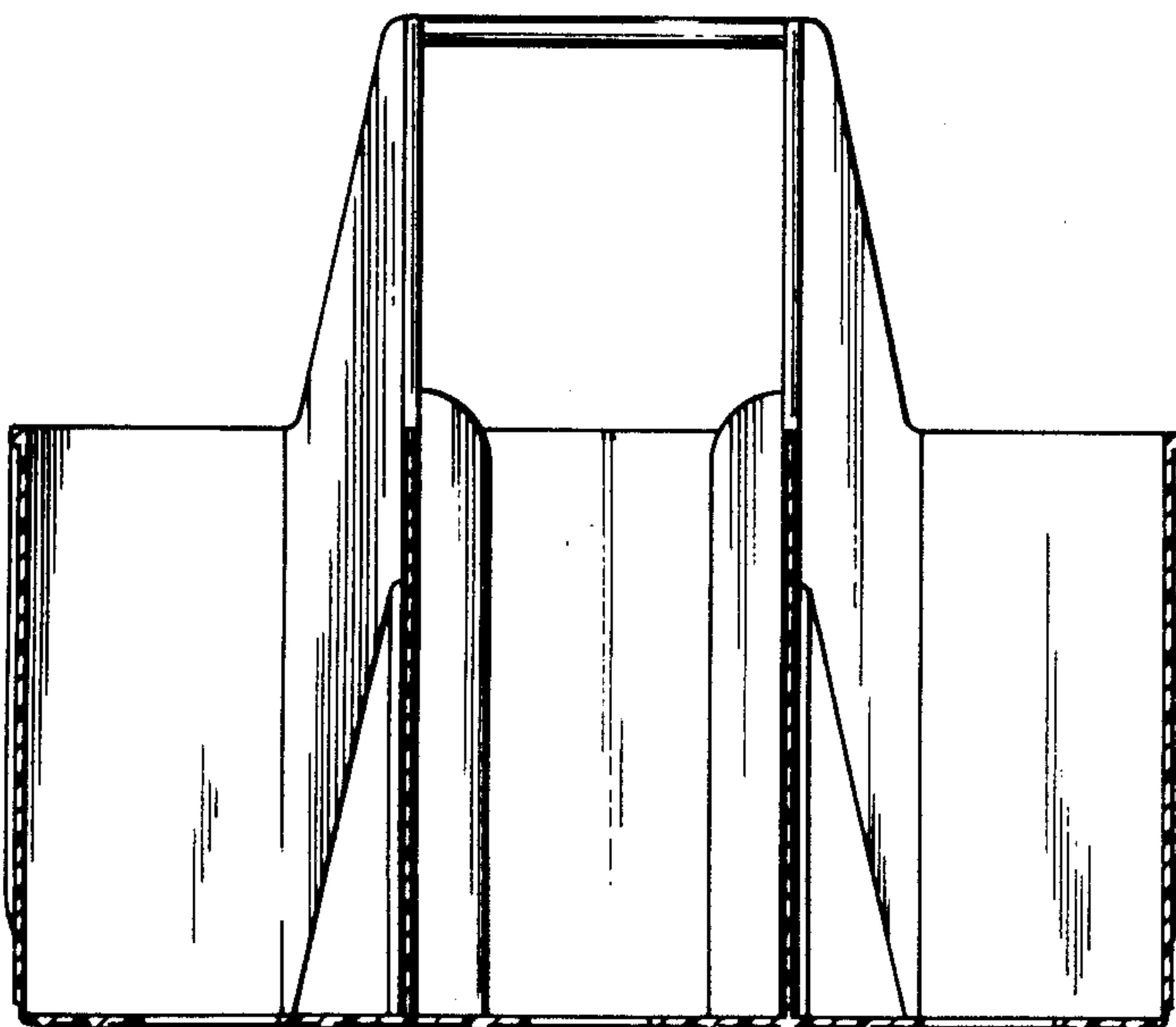

*FIG. 7*