

[54] **DISINFECTANT TRAY OR SIMILAR ARTICLE**

[76] Inventors: **Joseph J. Lancellotti**, 8 Starr Rd., East Brunswick, N.J. 08816; **Michel S. Schwartz**, 14 Clover Dr., Great Neck, N.Y. 11021

[**] Term: **14 Years**

[21] Appl. No.: **891,928**

[22] Filed: **Mar. 30, 1978**

[51] Int. Cl. **D24-02**

[52] U.S. Cl. **D24/31; D24/9; D24/30**

[58] Field of Search **D24/9, 31, 30; 422/297, 422/300, 310**

[56] **References Cited**

U.S. PATENT DOCUMENTS

D. 180,178	4/1957	Duray et al.	D24/9
1,309,117	7/1919	Darnall	422/310
2,786,245	3/1957	Steinbock	422/310

Primary Examiner—Sam Rosen
Attorney, Agent, or Firm—Arthur L. Plevy

[57] **CLAIM**

The ornamental design for a disinfectant tray or similar article, substantially as shown and described.

DESCRIPTION

FIG. 1 is a perspective view of the disinfectant tray or similar article showing our new design, with the handle in the closed position;

FIG. 2 is a perspective view thereof showing the handle in an open position;

FIG. 3 is a top plan view of the tray of FIG. 1;

FIG. 4 is a bottom plan view of the tray of FIG. 1;

FIG. 5 is a front elevational view of the tray of FIG. 1;

FIG. 6 is a rear elevational view of the tray of FIG. 1; and

FIG. 7 is a left side elevational view of the tray of FIG. 1 with the opposite side being a mirror image.

The apertures of FIGS. 2 and 4 are incompletely shown for ease of illustration but form a repeating pattern such as shown in FIG. 3.

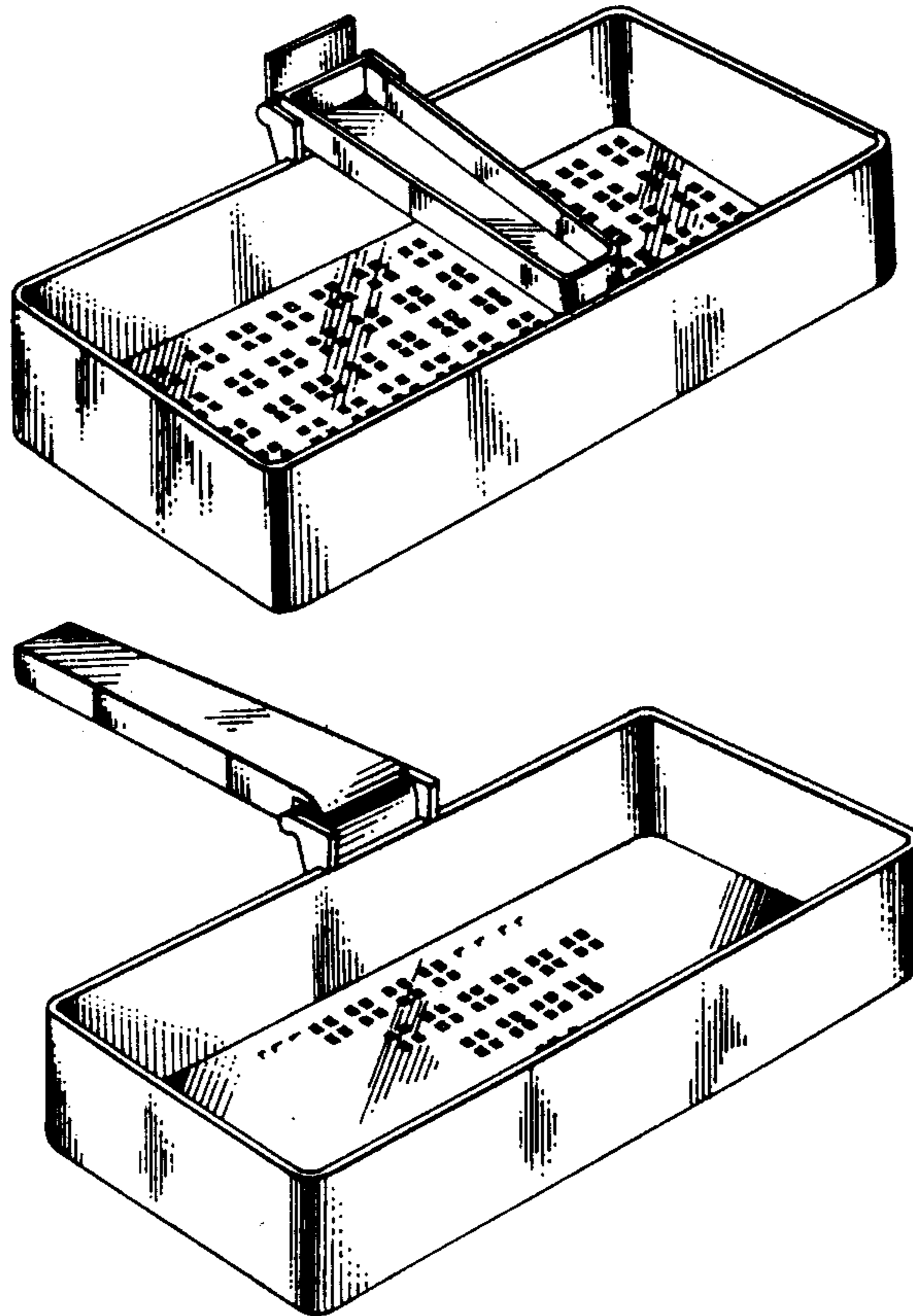

Fig. 1.

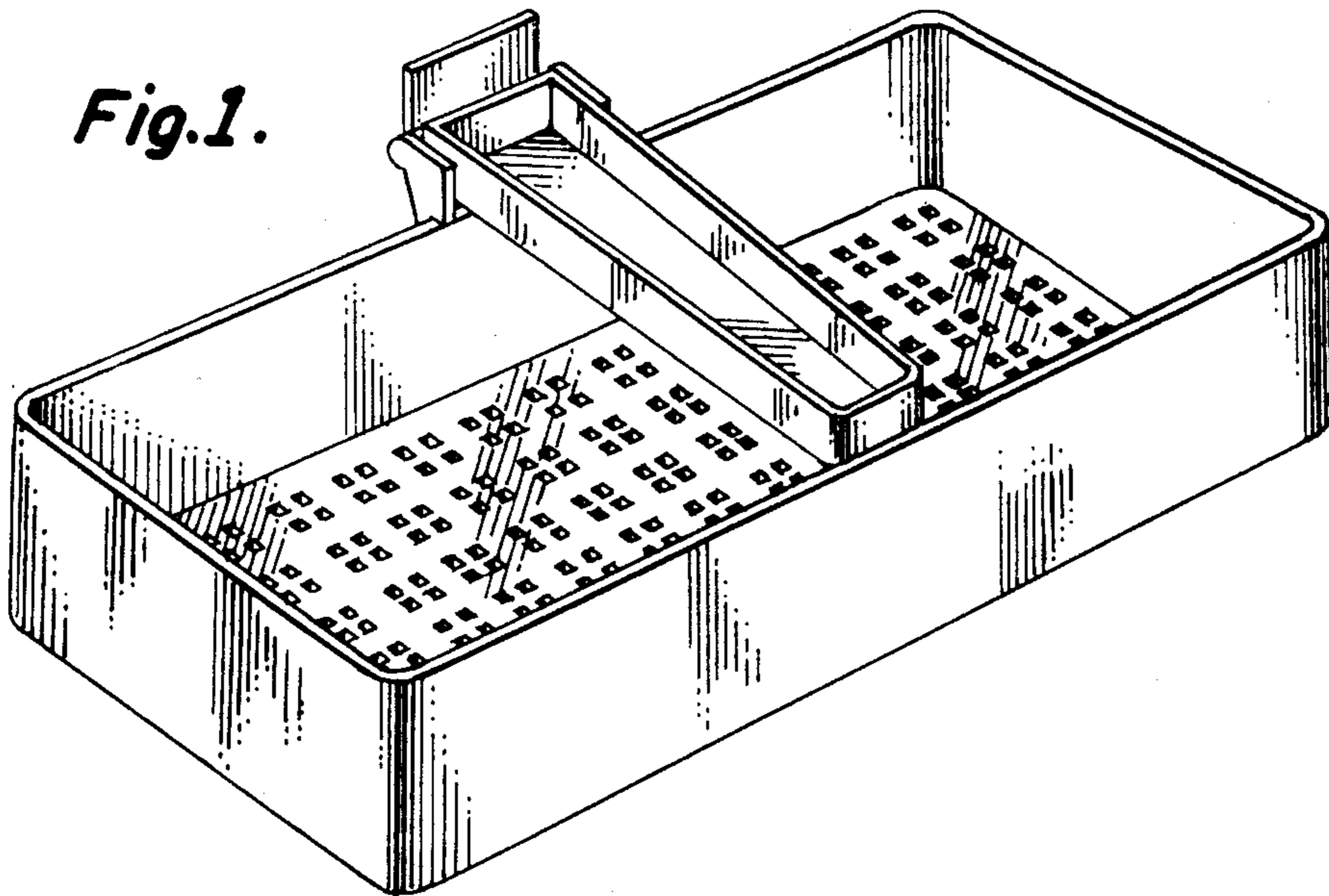

Fig. 2.

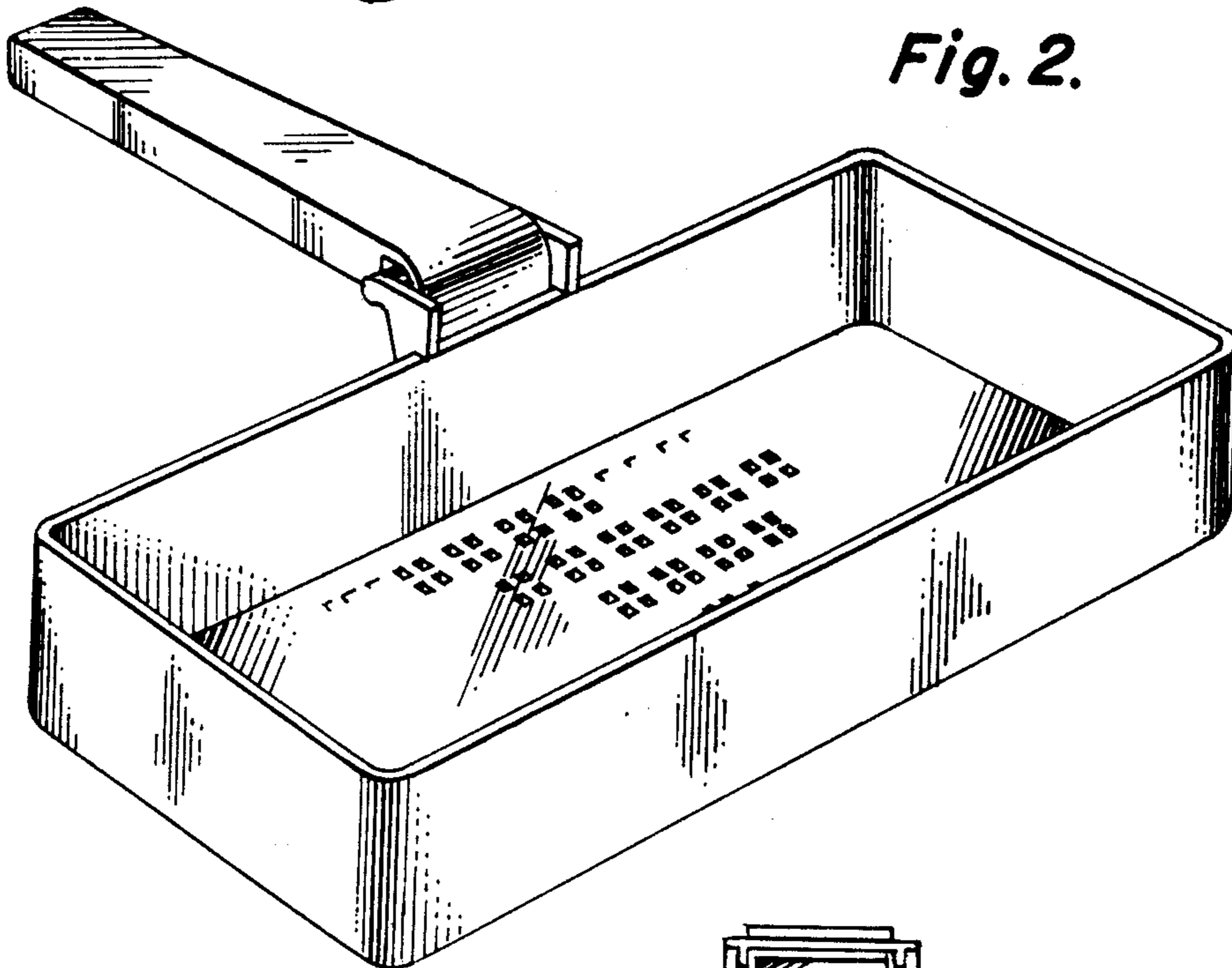

Fig. 3.

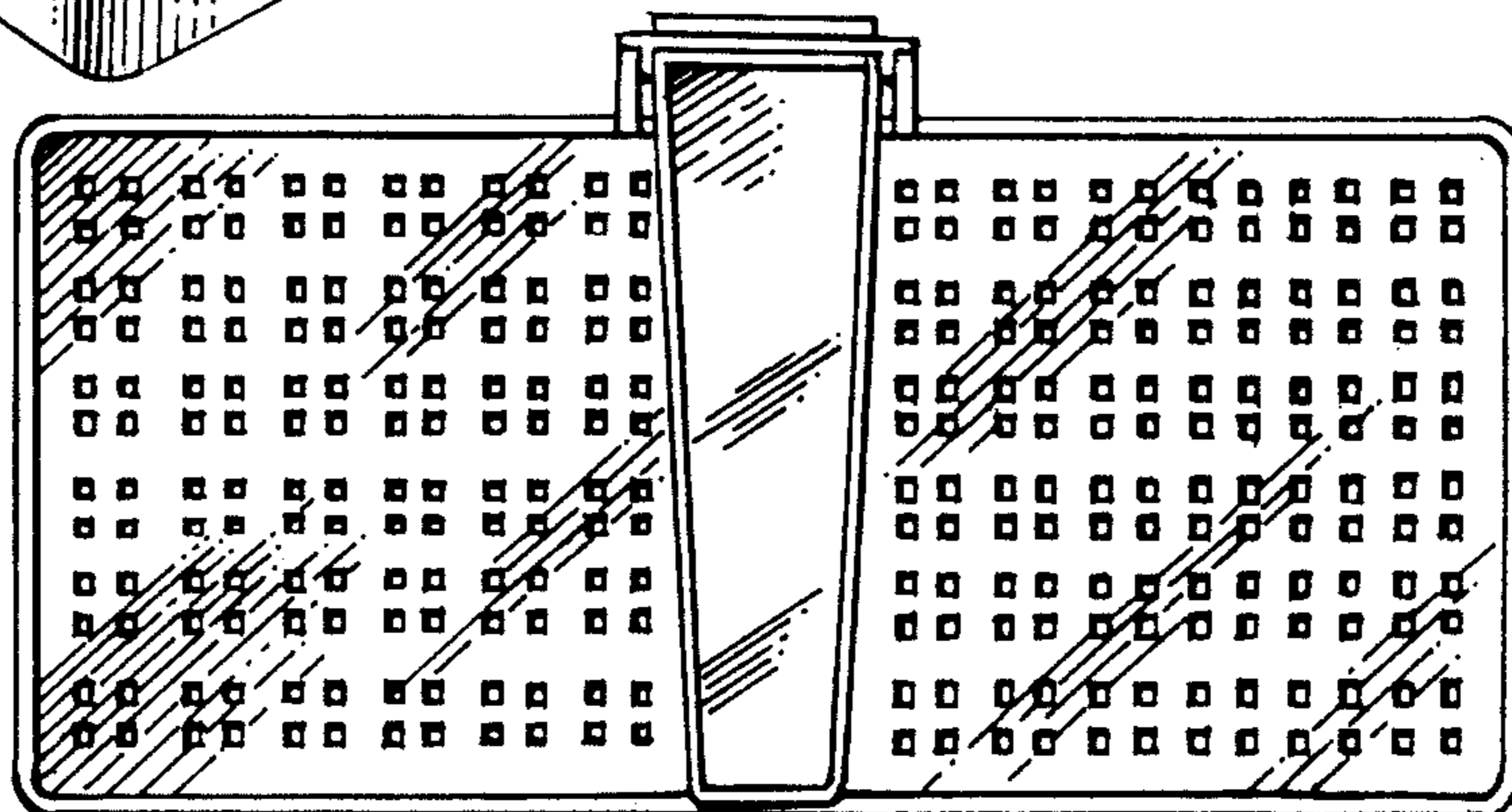

Fig. 4.

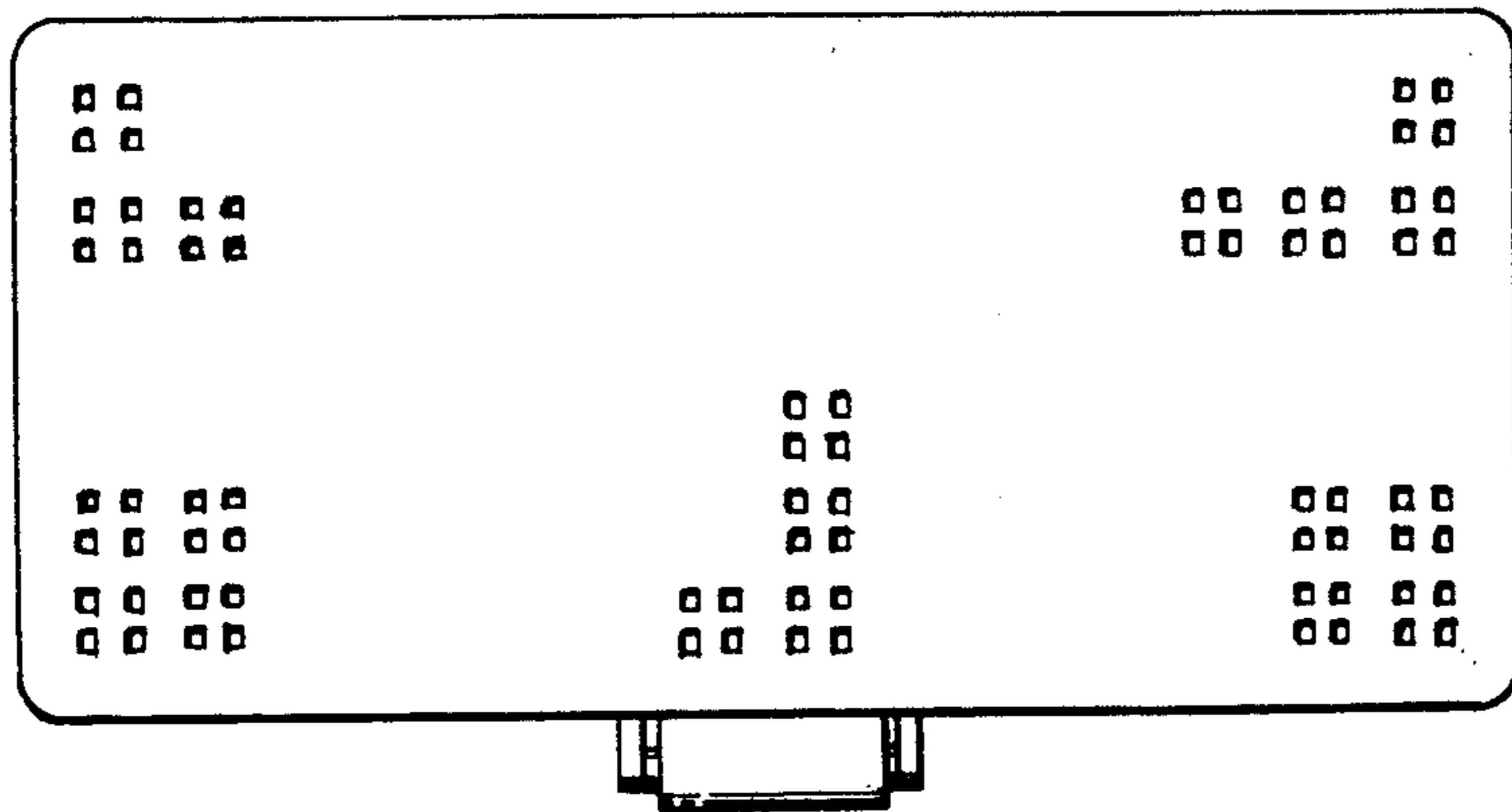

Fig. 5.

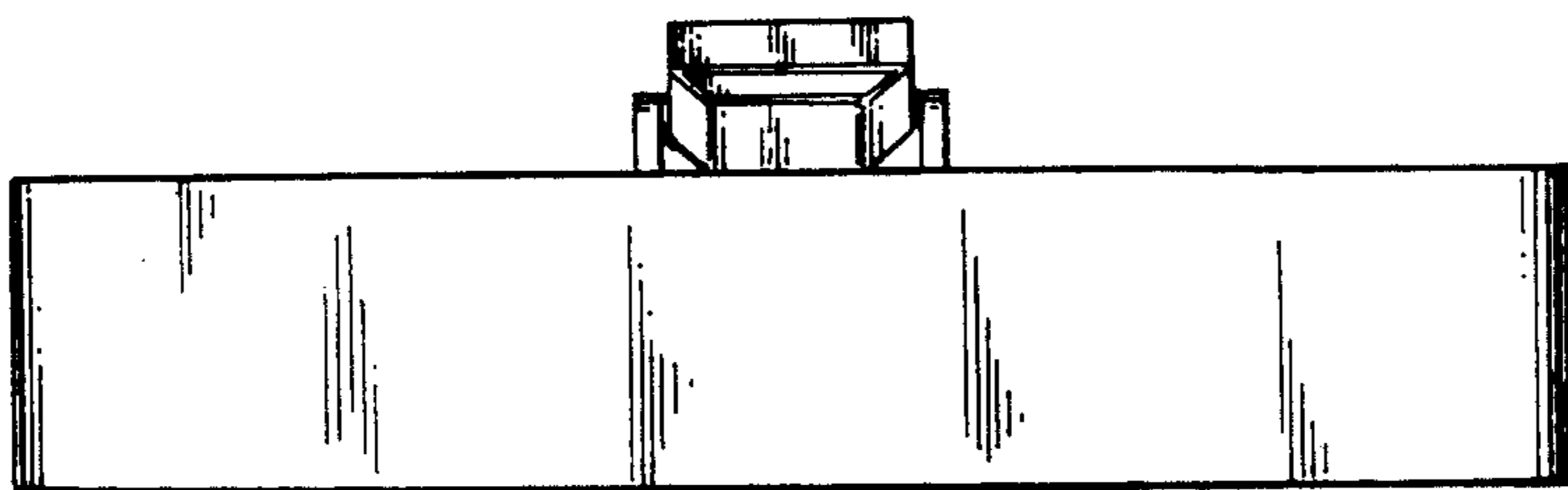

Fig. 6.

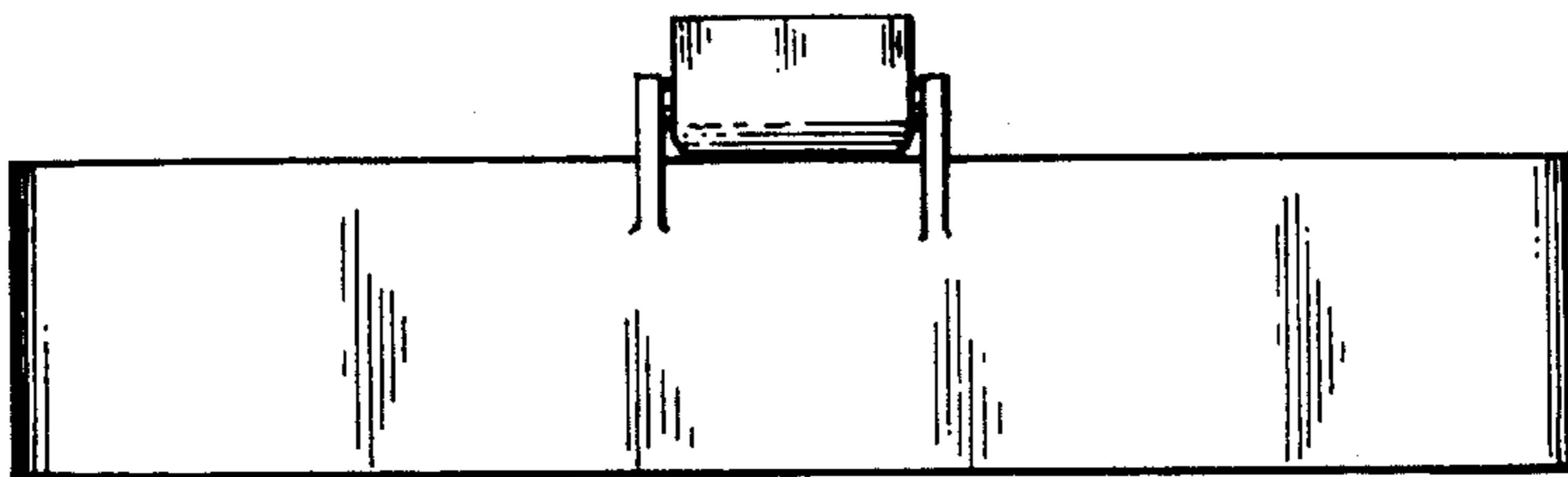

Fig. 7.

