

[54] PEDESTAL LAVATORY

3,881,200 5/1975 Gerber 4/639

[75] Inventor: Donald W. Doman, Janesville, Wis.

OTHER PUBLICATIONS

[73] Assignee: Kohler Co., Kohler, Wis.

Design, Aug. 1961, p. 10.
Stile Industria, Oct. 1960, p. VII, Pedestal Lavatory Item.

[**] Term: 14 Years

Primary Examiner—James R. Largen
Attorney, Agent, or Firm—Quarles & Brady

[21] Appl. No.: 42,208

[22] Filed: May 24, 1979

[57] CLAIM

[51] Int. Cl. D23-02

The ornamental design for a pedestal lavatory, as shown.

[52] U.S. Cl. D23/61

[58] Field of Search D23/48, 58-64;
4/619, 624, 643, 649

DESCRIPTION

[56] References Cited

U.S. PATENT DOCUMENTS

D. 41,842	10/1911	Gavin	D23/61
D. 45,283	2/1914	Allen	D23/61
D. 75,583	6/1928	McFeely	D23/61
D. 77,934	3/1929	Burbank	D23/61 W
D. 101,446	10/1936	Dreyfuss et al.	D23/61
D. 125,054	2/1941	Lewb	D23/61
D. 201,344	6/1965	Stairs, Jr.	D23/58
D. 202,410	9/1965	Sundberg et al.	D23/58
1,136,091	4/1915	Bloom	4/194

FIG. 1 is a perspective view of a pedestal lavatory showing my new design;
FIG. 2 is a top plan view thereof;
FIG. 3 is a front elevational view thereof;
FIG. 4 is a side elevational view thereof;
FIG. 5 is a cross sectional view of the bowl portion of the pedestal lavatory taken on line 5-5 of FIG. 2;
FIG. 6 is a cross sectional view of the bowl portion of the pedestal lavatory taken on line 6-6 of FIG. 2; and
FIG. 7 is a cross sectional view taken on line 7-7 of FIG. 4.

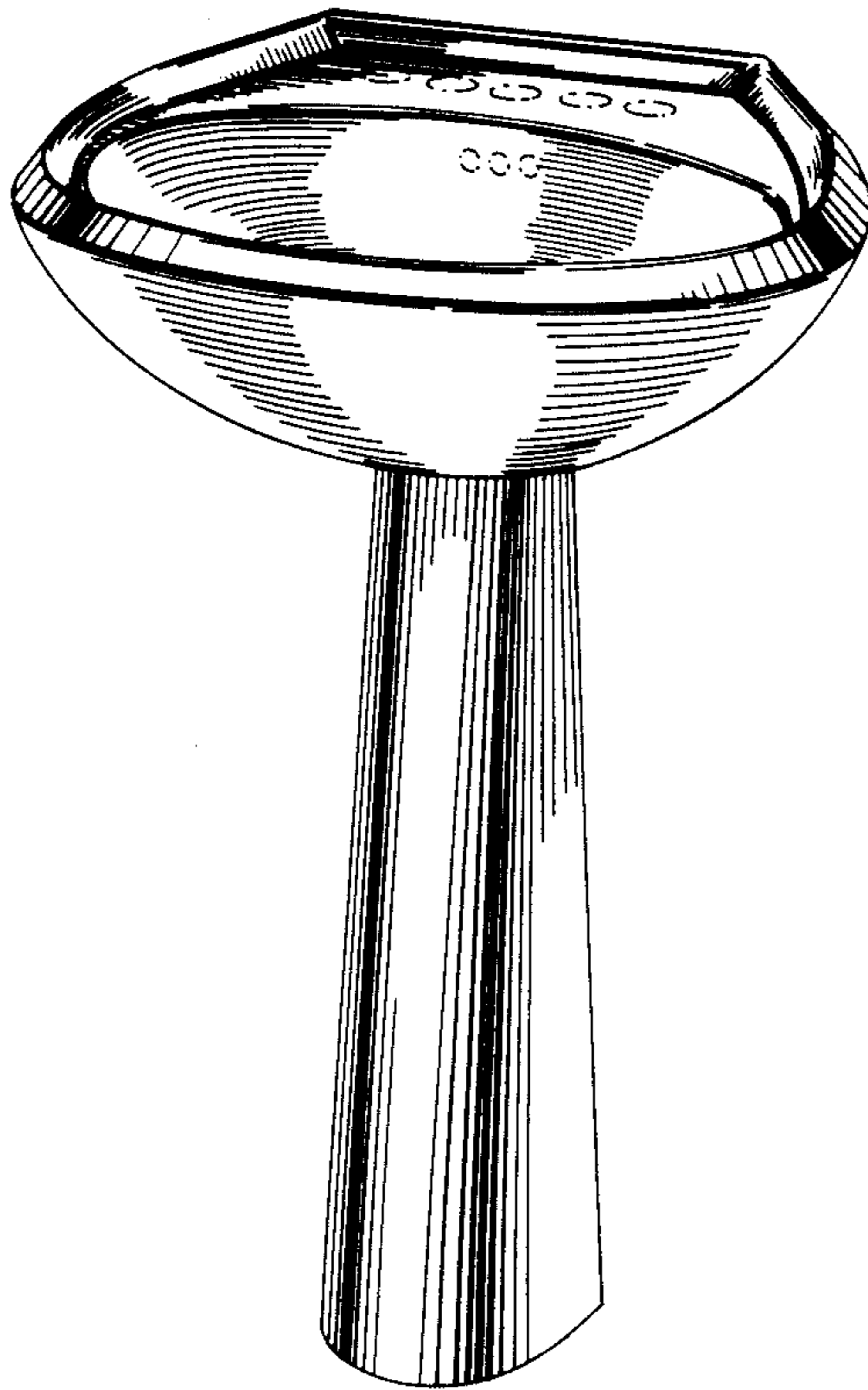

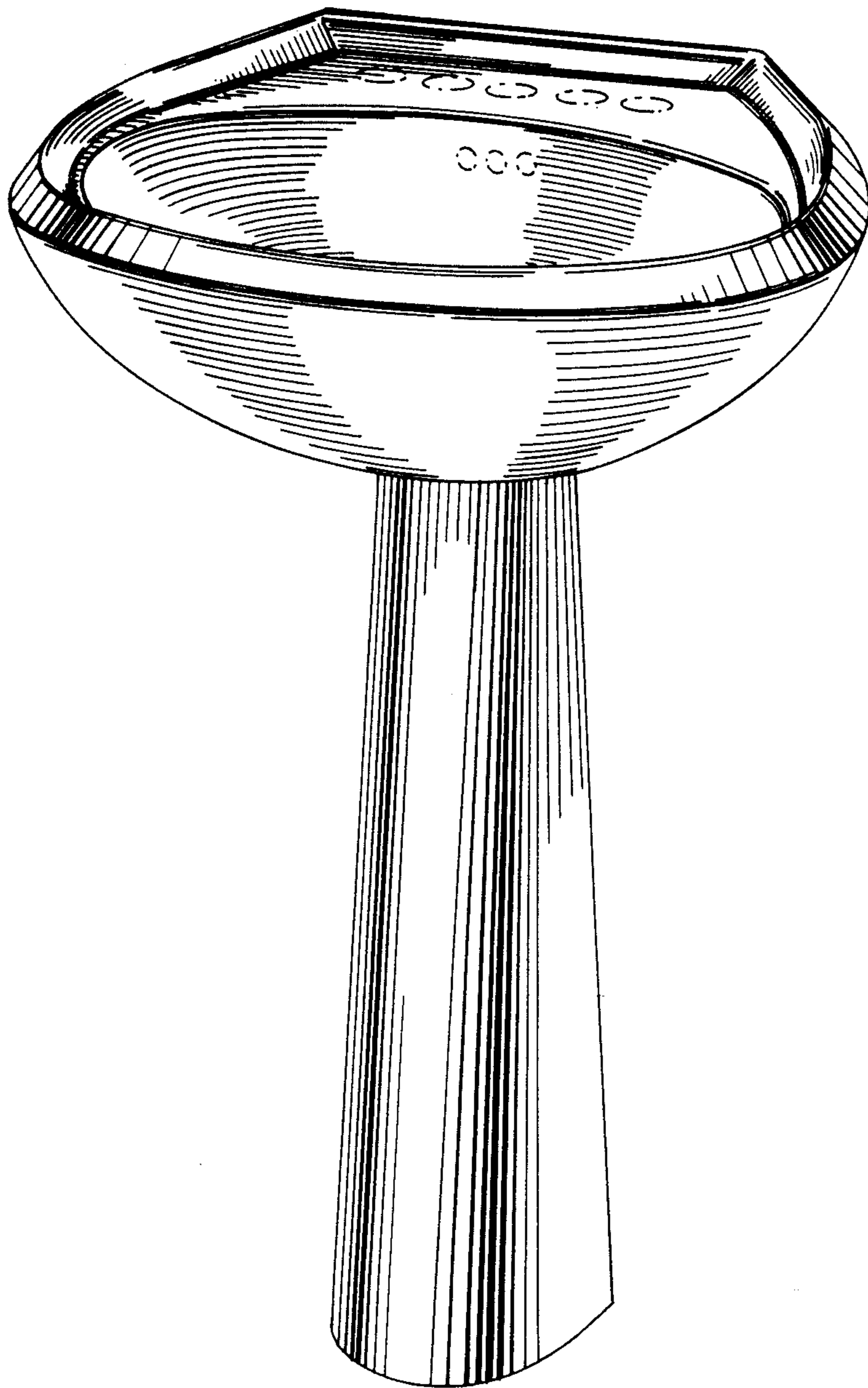

Fig. 1

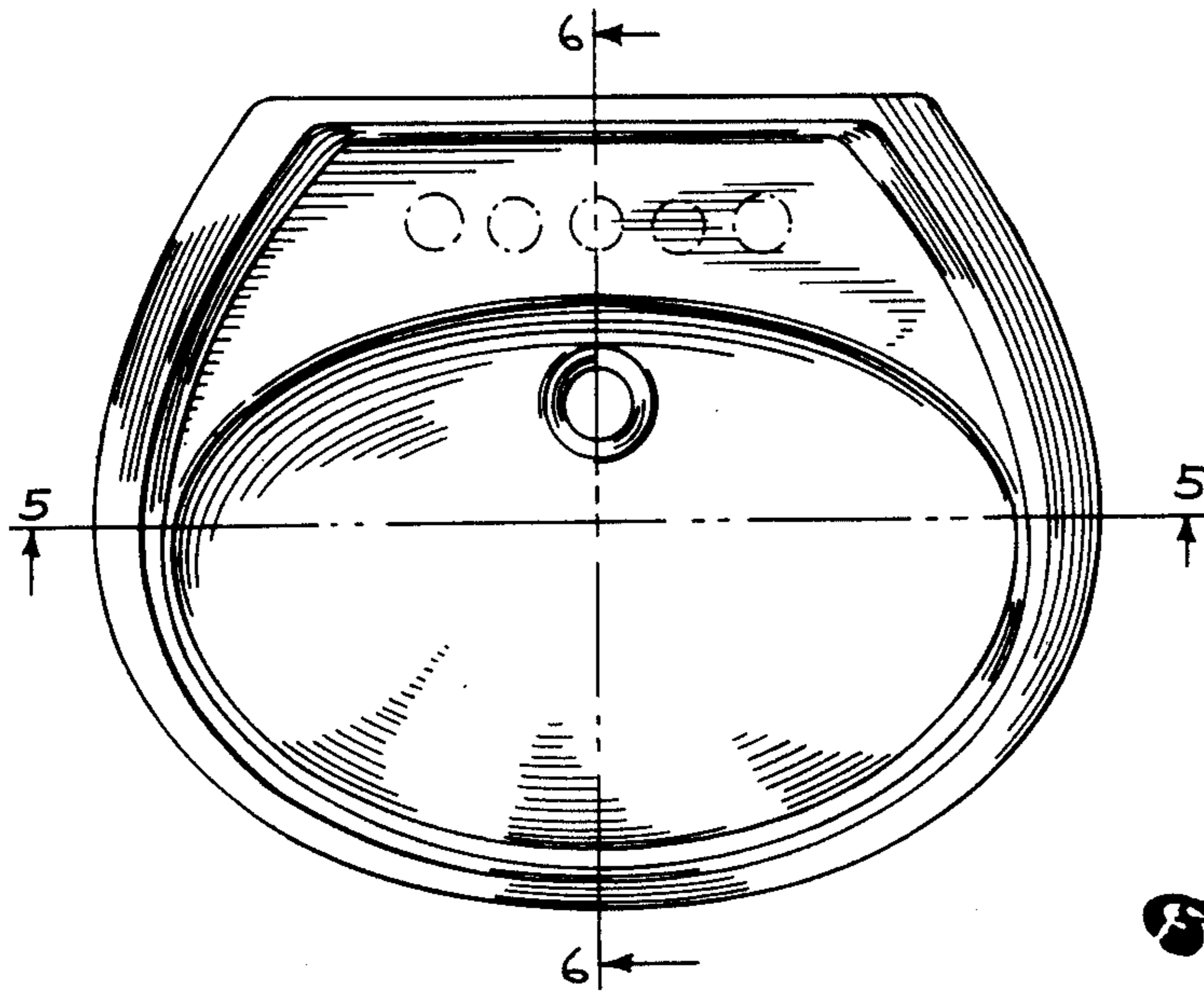

Fig. 2

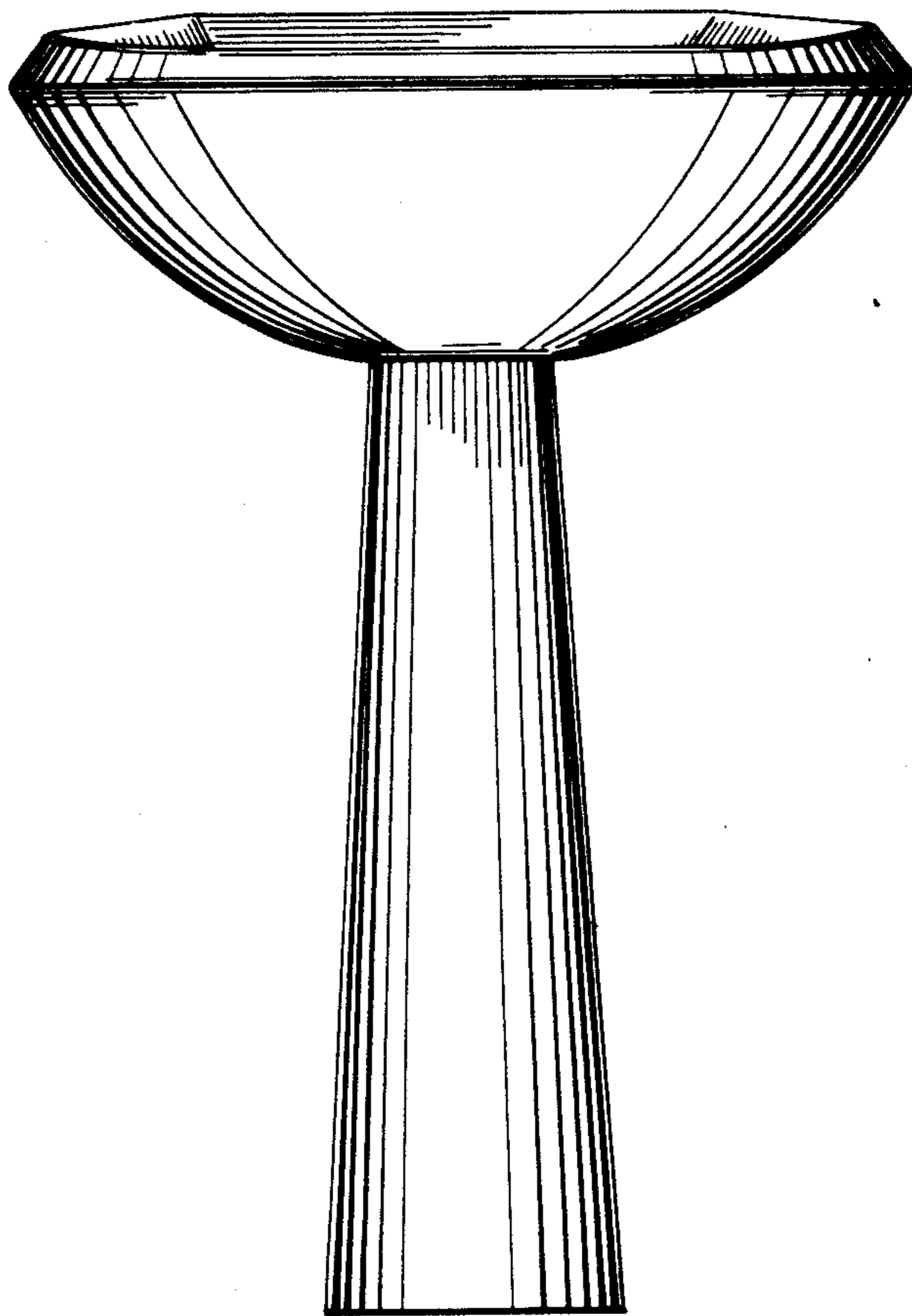

Fig. 3

Fig. 4

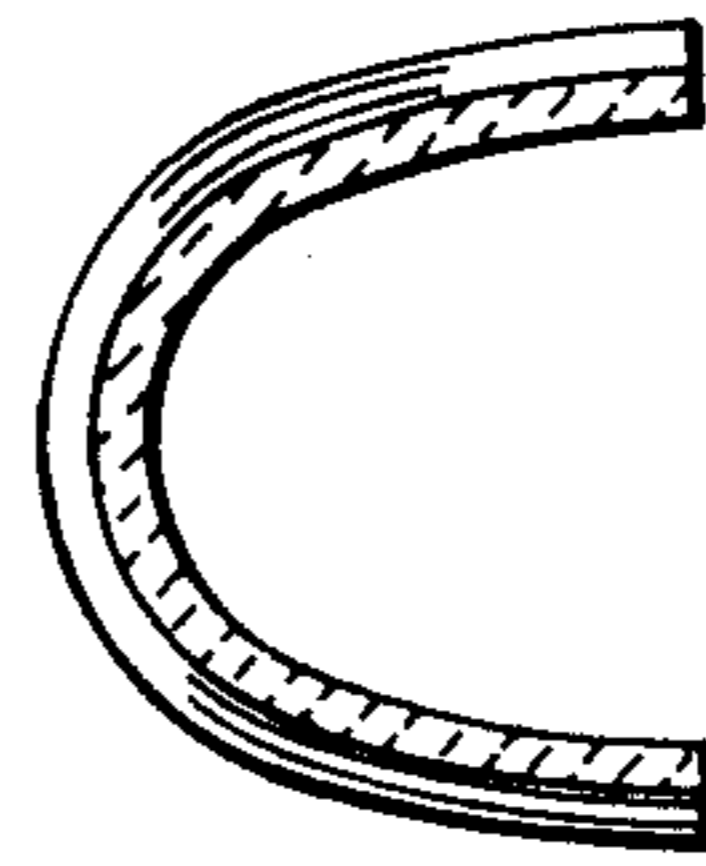
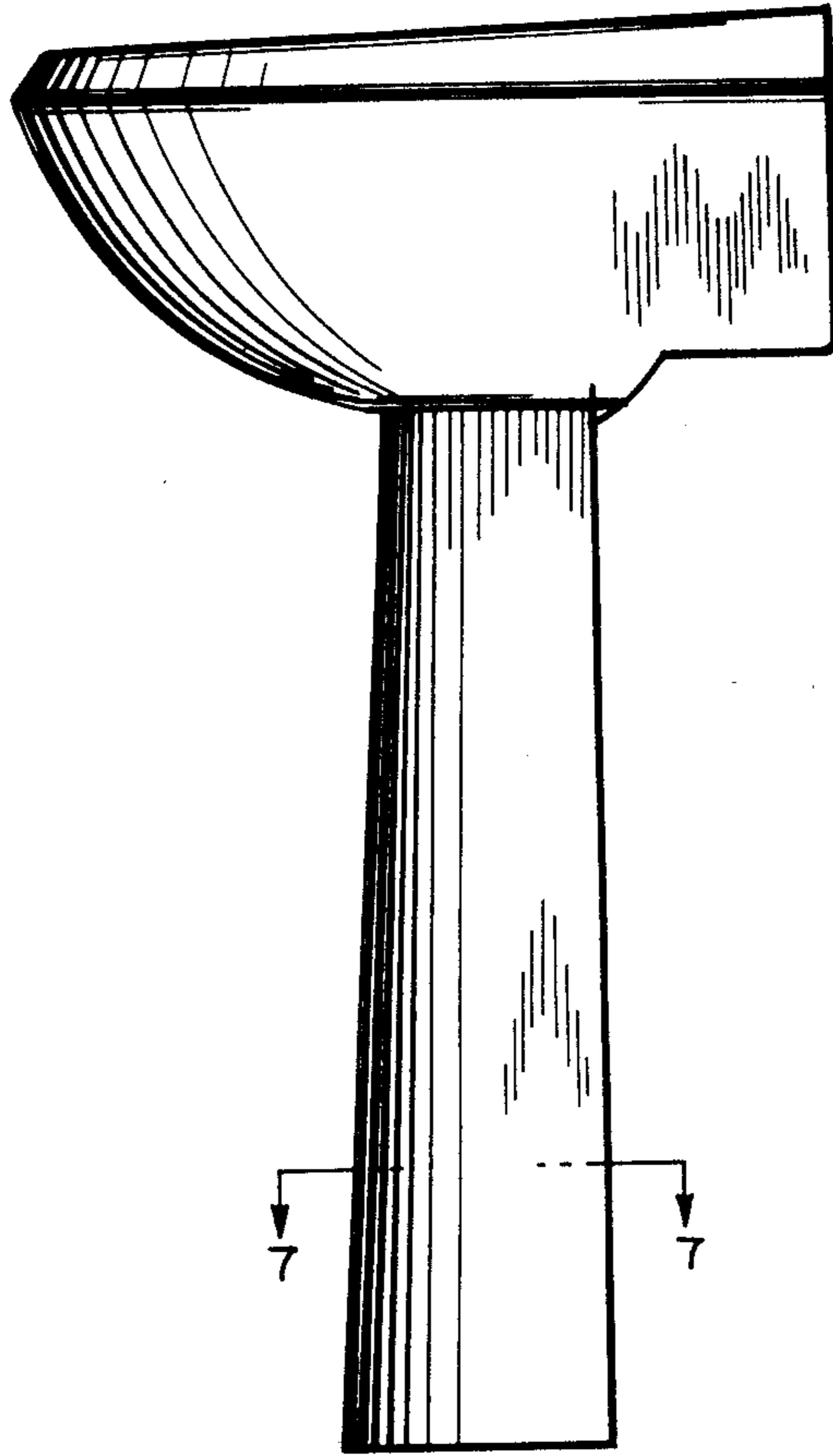

Fig. 7

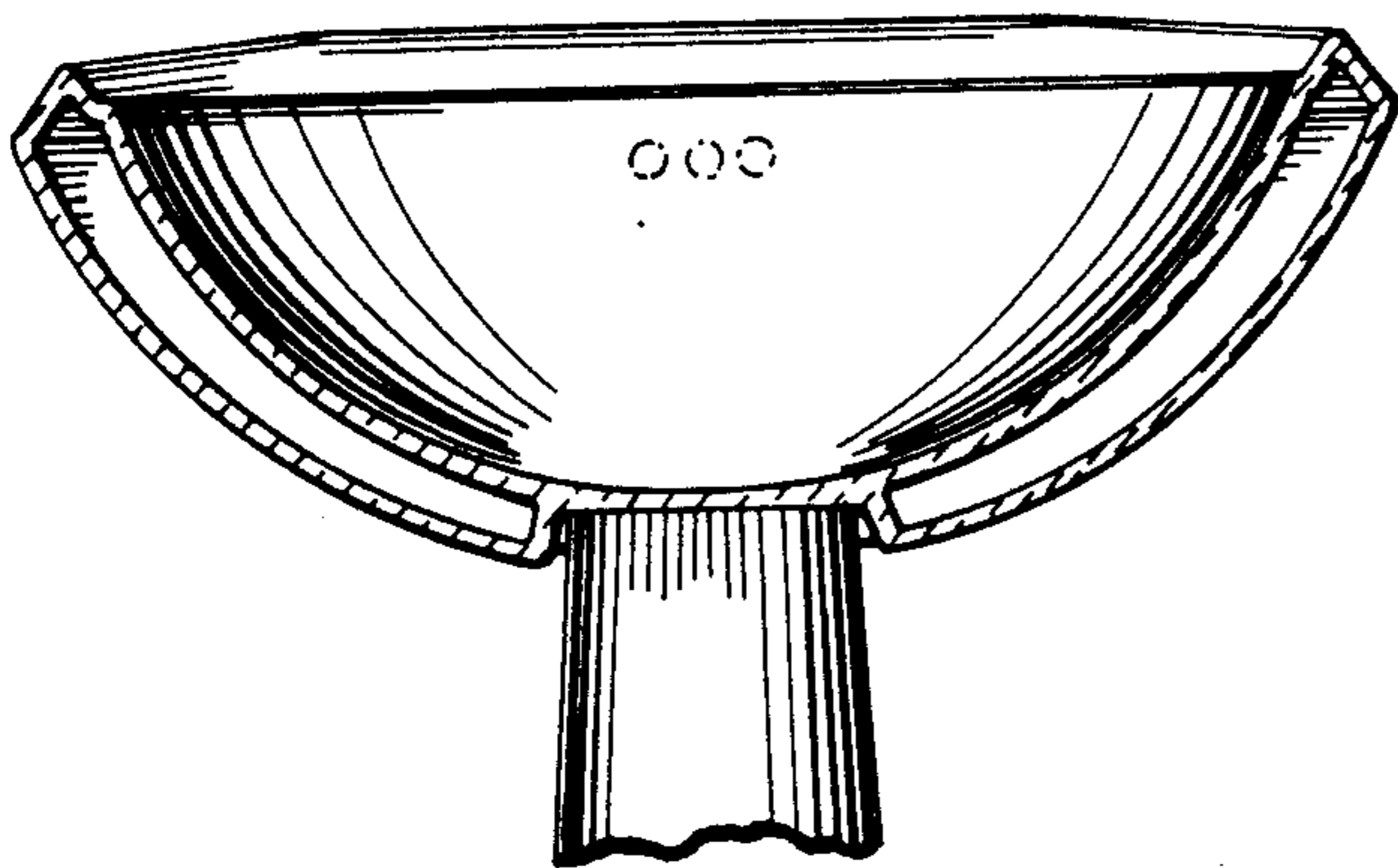

Fig. 5

Fig. 6

