

[54] PARTITIONED CUP

406979 12/1909 France ..... 220/94 A

[76] Inventor: Elias A. Paulides, 260 E. Walnut St., Long Beach, N.Y. 11561

OTHER PUBLICATIONS

*Earnshaw's Review*, Feb. 1978, p. 43, Item #30-R. mid. panel, described in #29-Chicco Baby Nipple Training Cup.

[\*\*] Term: 14 Years

Primary Examiner—Winifred E. Herrmann  
Attorney, Agent, or Firm—Abraham Friedman

[21] Appl. No.: 34,637

[22] Filed: Apr. 30, 1979

[57] CLAIM

[51] Int. Cl. .... D07-01

[52] U.S. Cl. .... D7/10; D7/6

[58] Field of Search ..... D7/6, 97, 132, 9, 10, D7/20; 220/90.2, 90.4, 94 A

The ornamental design for a partitioned cup, substantially as shown.

DESCRIPTION

FIG. 1 is a perspective view of a partitioned cup showing my new design;

FIG. 2 is a top plan view;

FIG. 3 is a right side elevational view;

FIG. 4 is a rear elevational view;

FIG. 5 is a bottom plan view;

FIG. 6 is a fragmented sectional view taken along line 6-6 of FIG. 4; and

FIG. 7 is a fragmented sectional view taken along line 7-7 of FIG. 4.

[56] References Cited

U.S. PATENT DOCUMENTS

2,162,629	6/1939	McBride .....	D7/6 X
2,640,337	6/1953	Bryant .....	D7/6 X
3,400,855	9/1968	Alexander .....	220/90.4
4,096,966	6/1978	Korshak .....	D7/10 X
4,121,731	10/1978	Okerstrum .....	D7/10 X

FOREIGN PATENT DOCUMENTS

2137184 2/1973 Fed. Rep. of Germany ..... 220/90.2

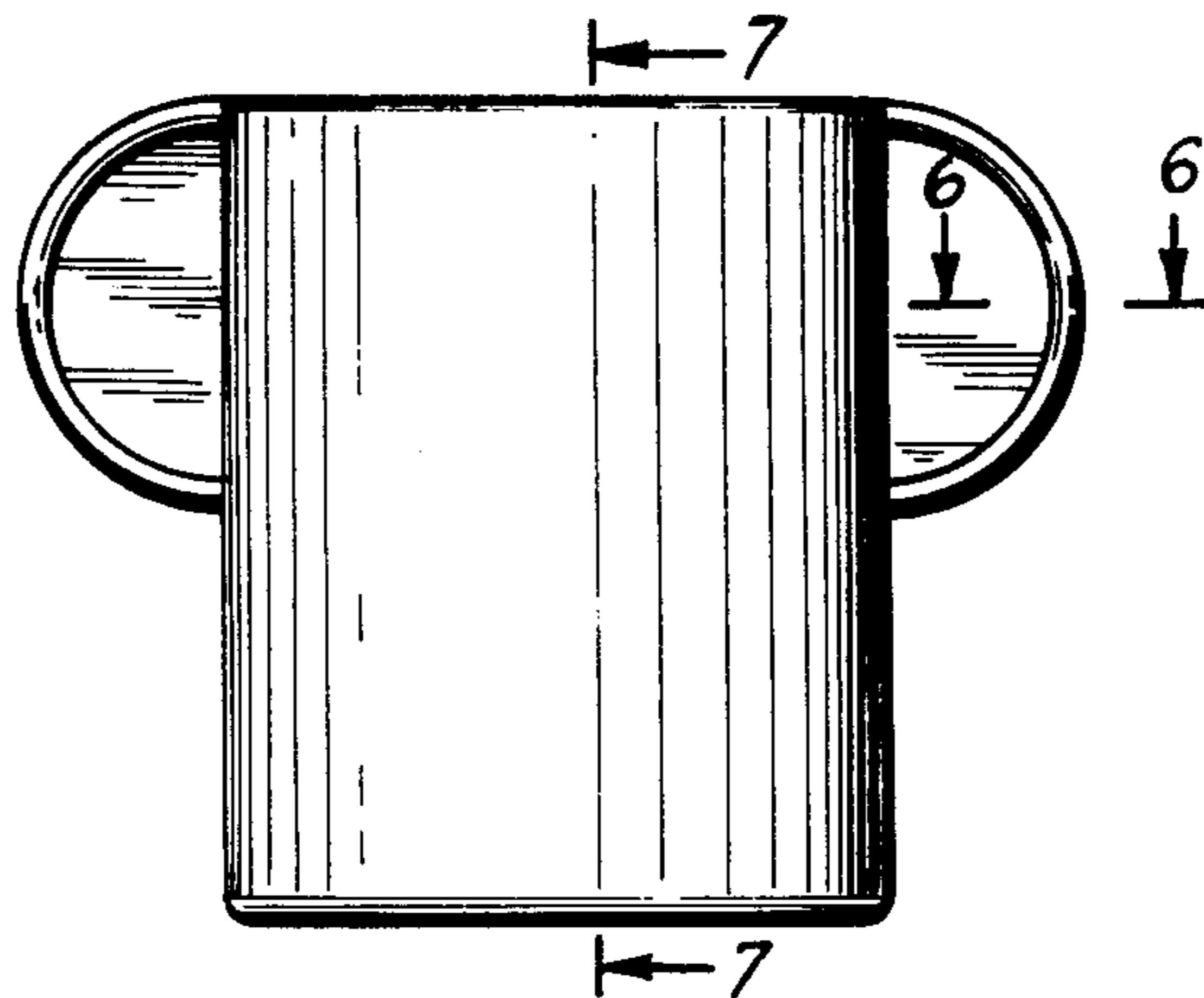
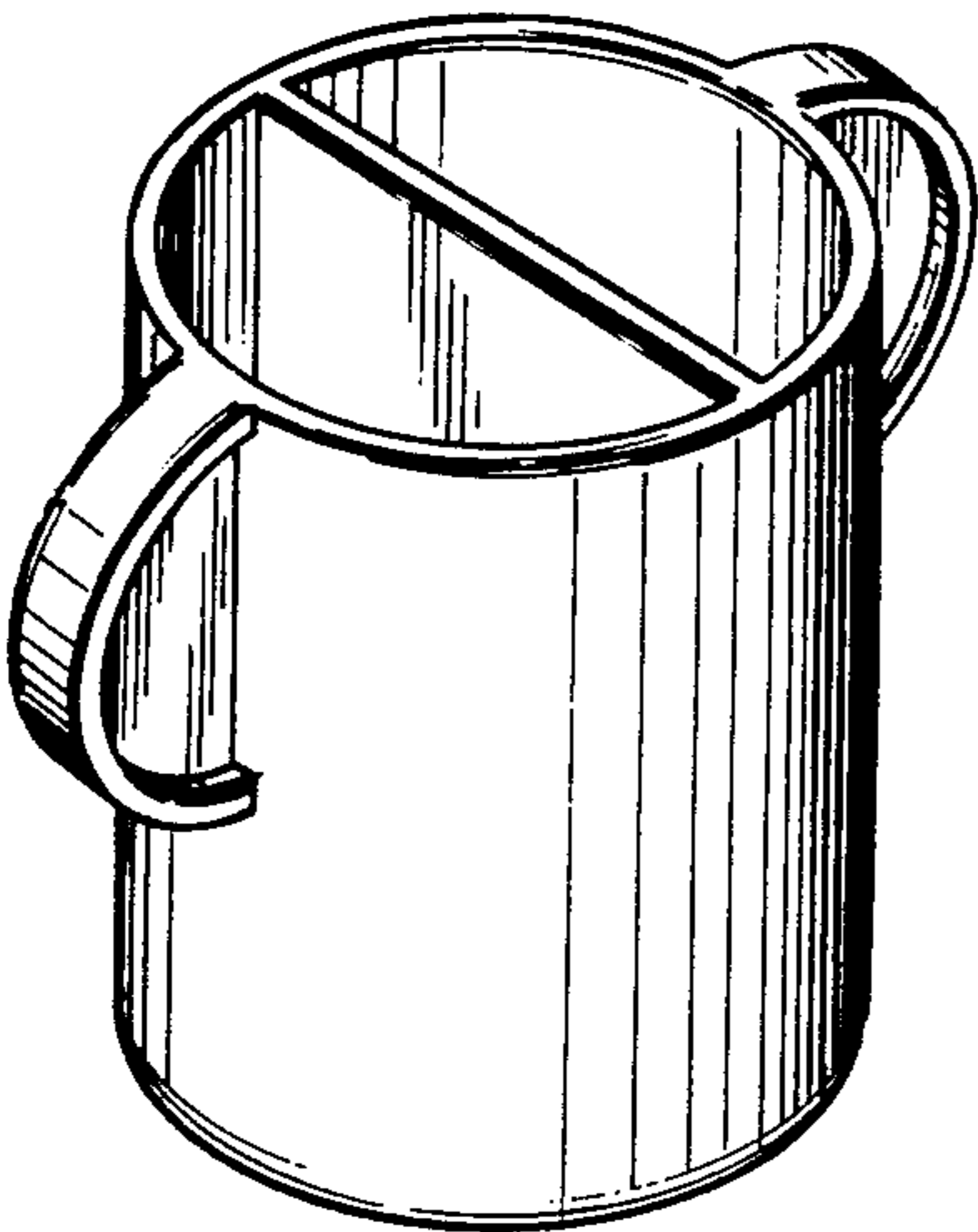

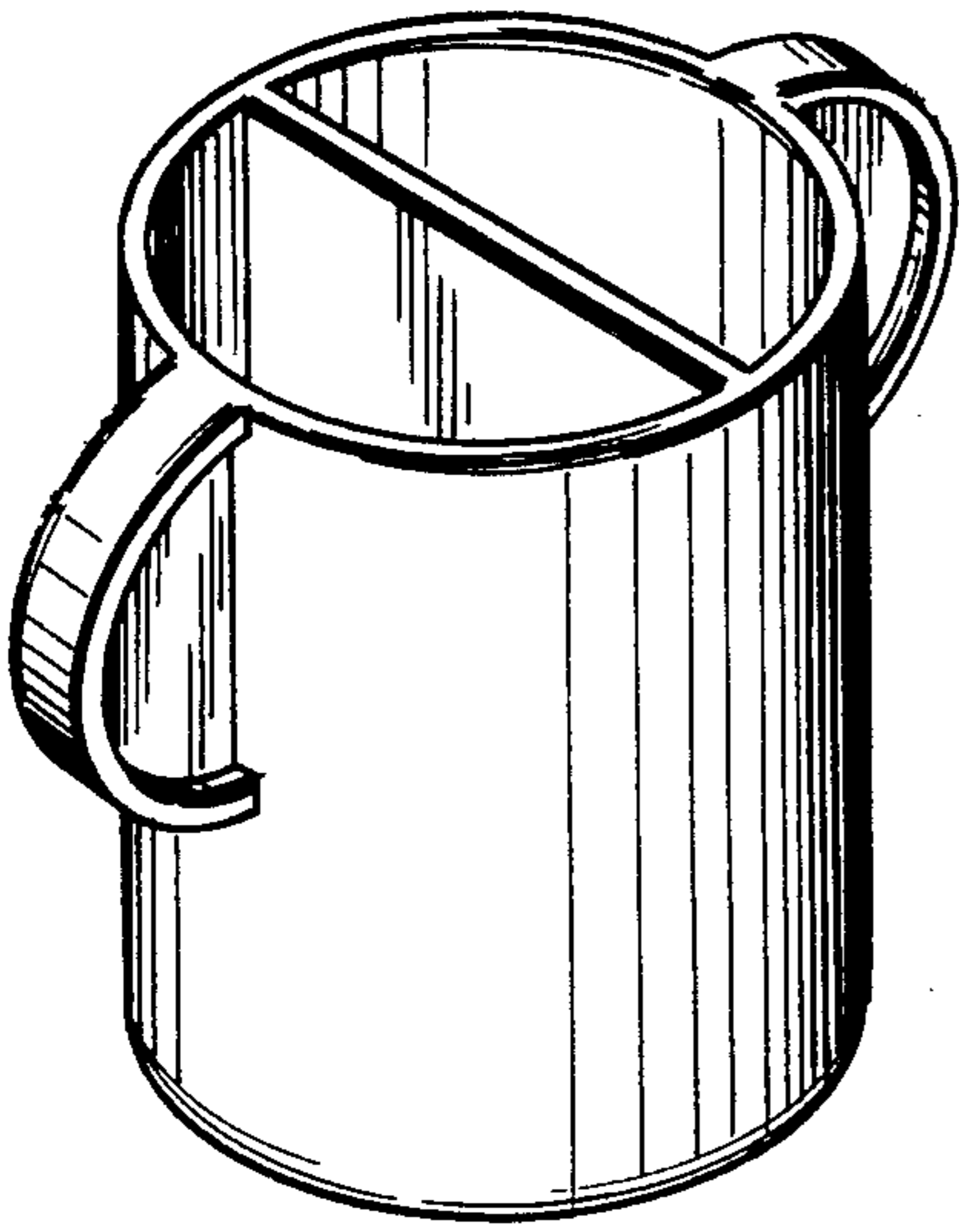

FIG. 1

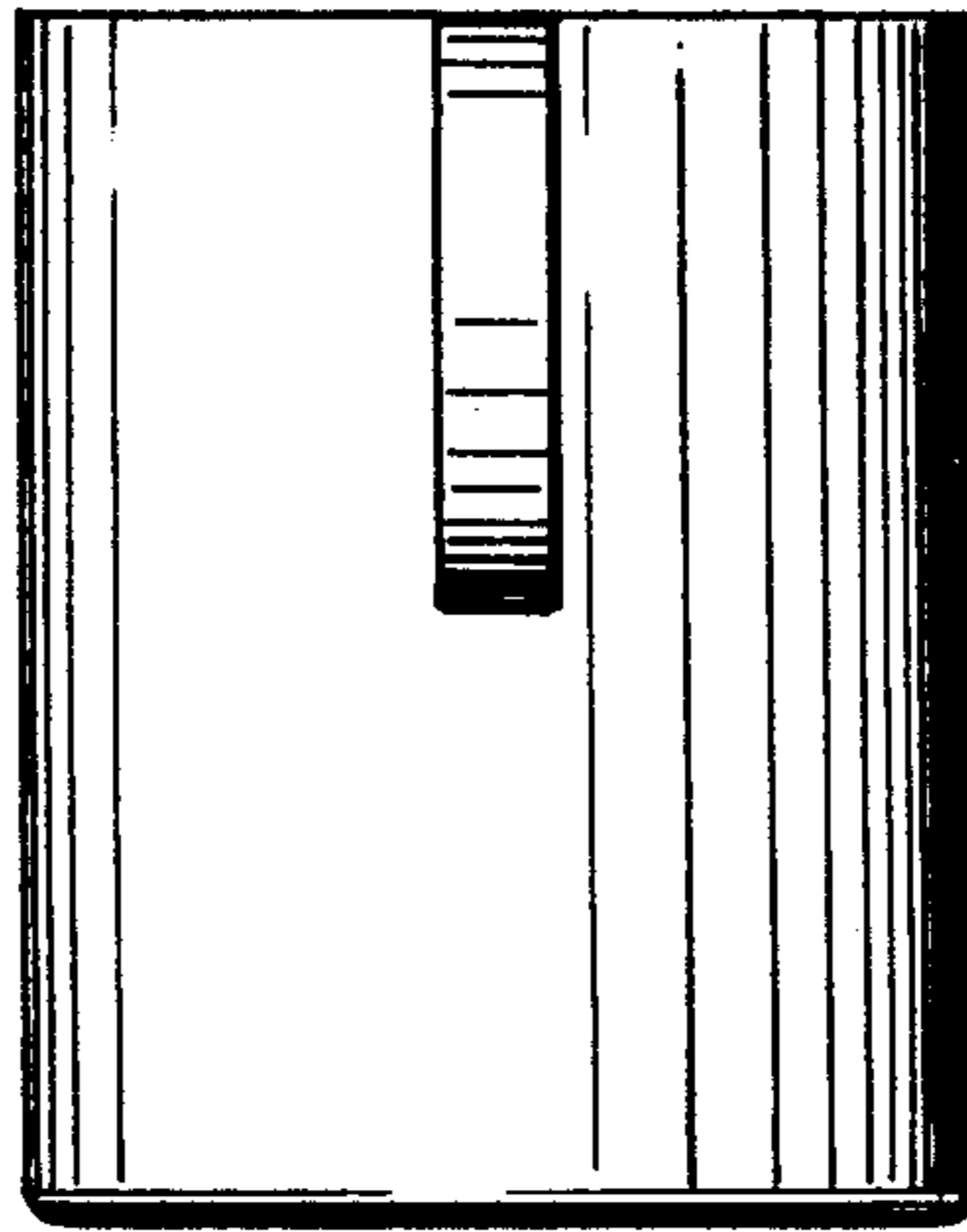

FIG. 3

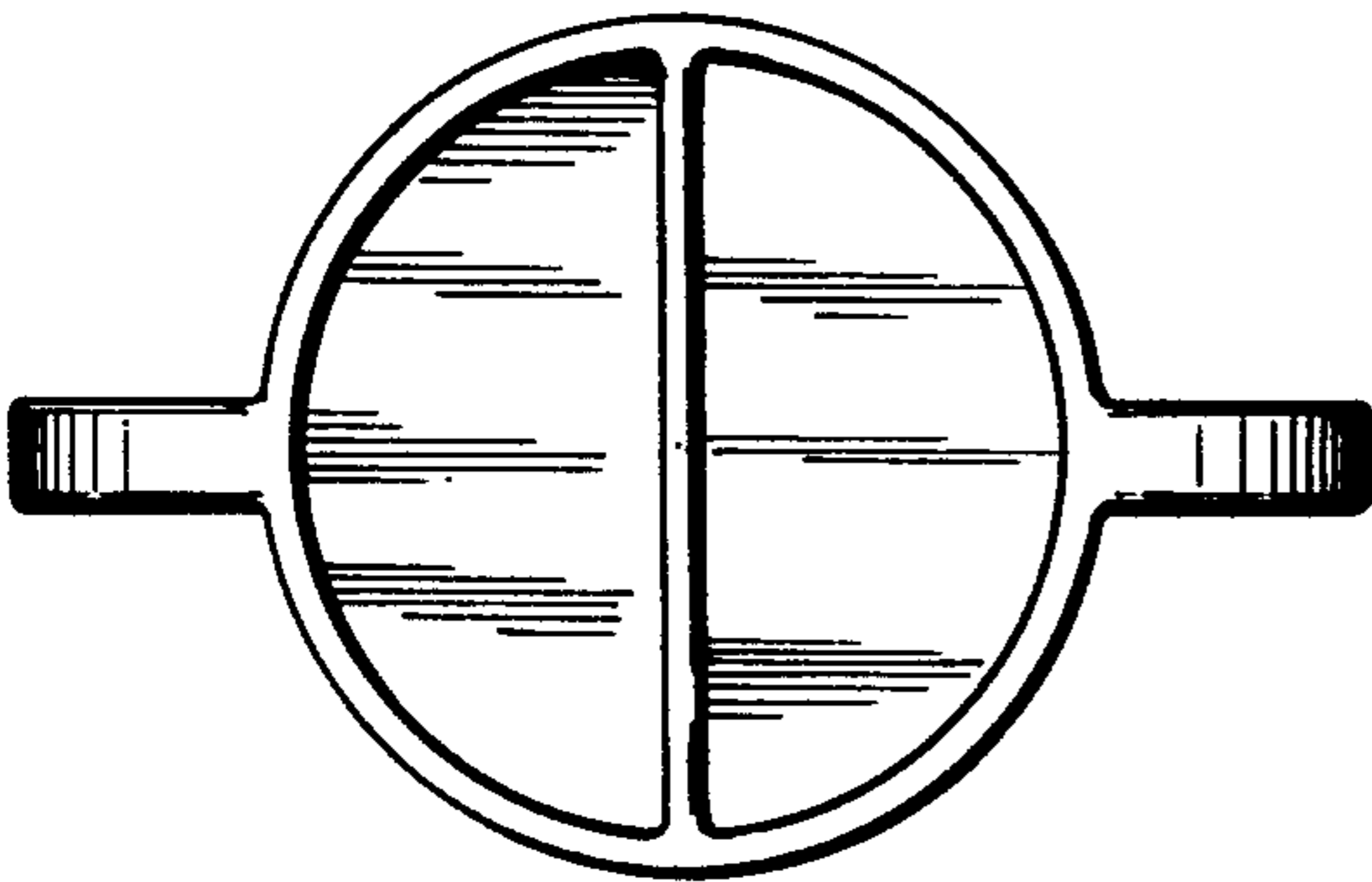

FIG. 2

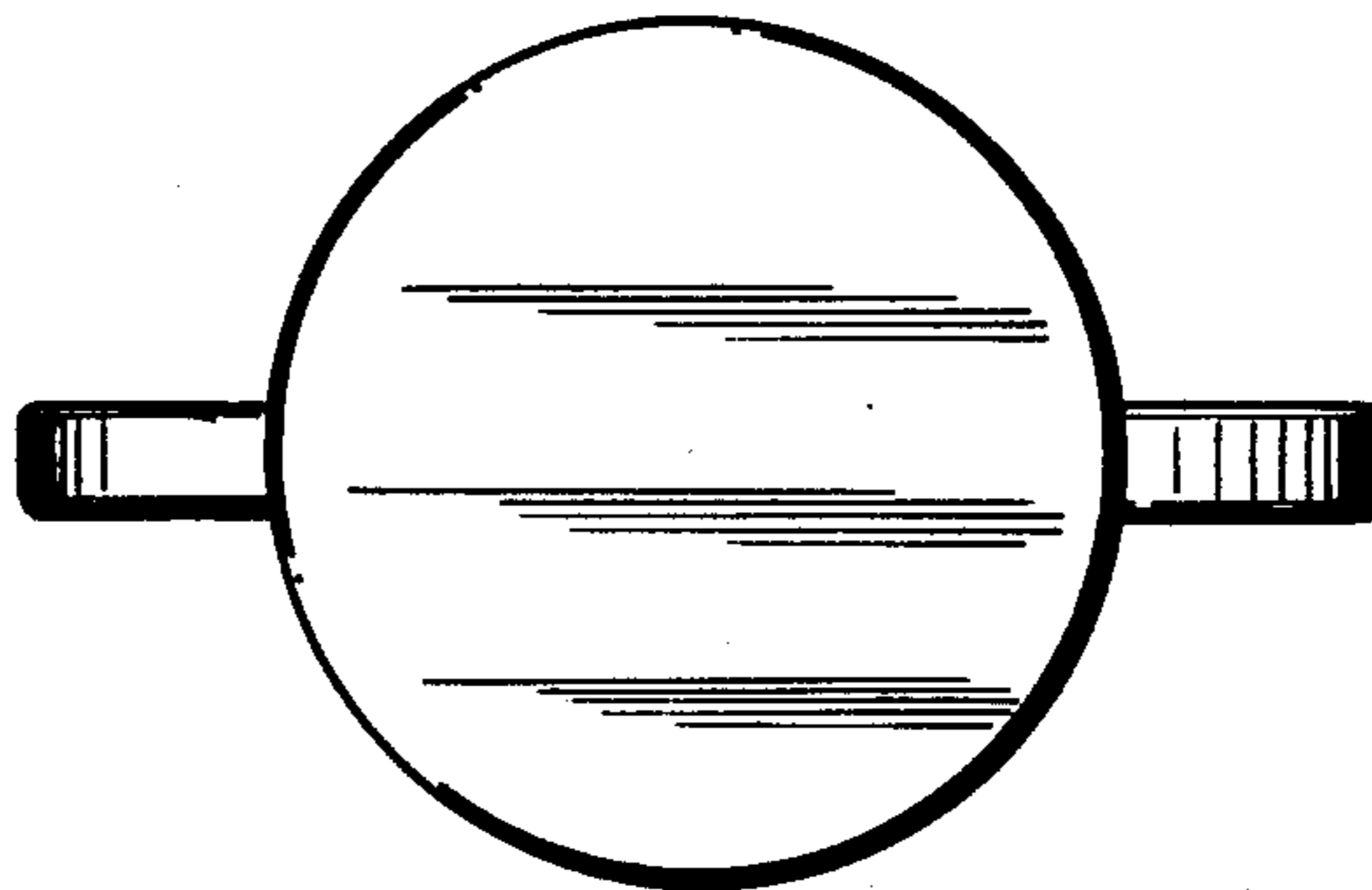

FIG. 5

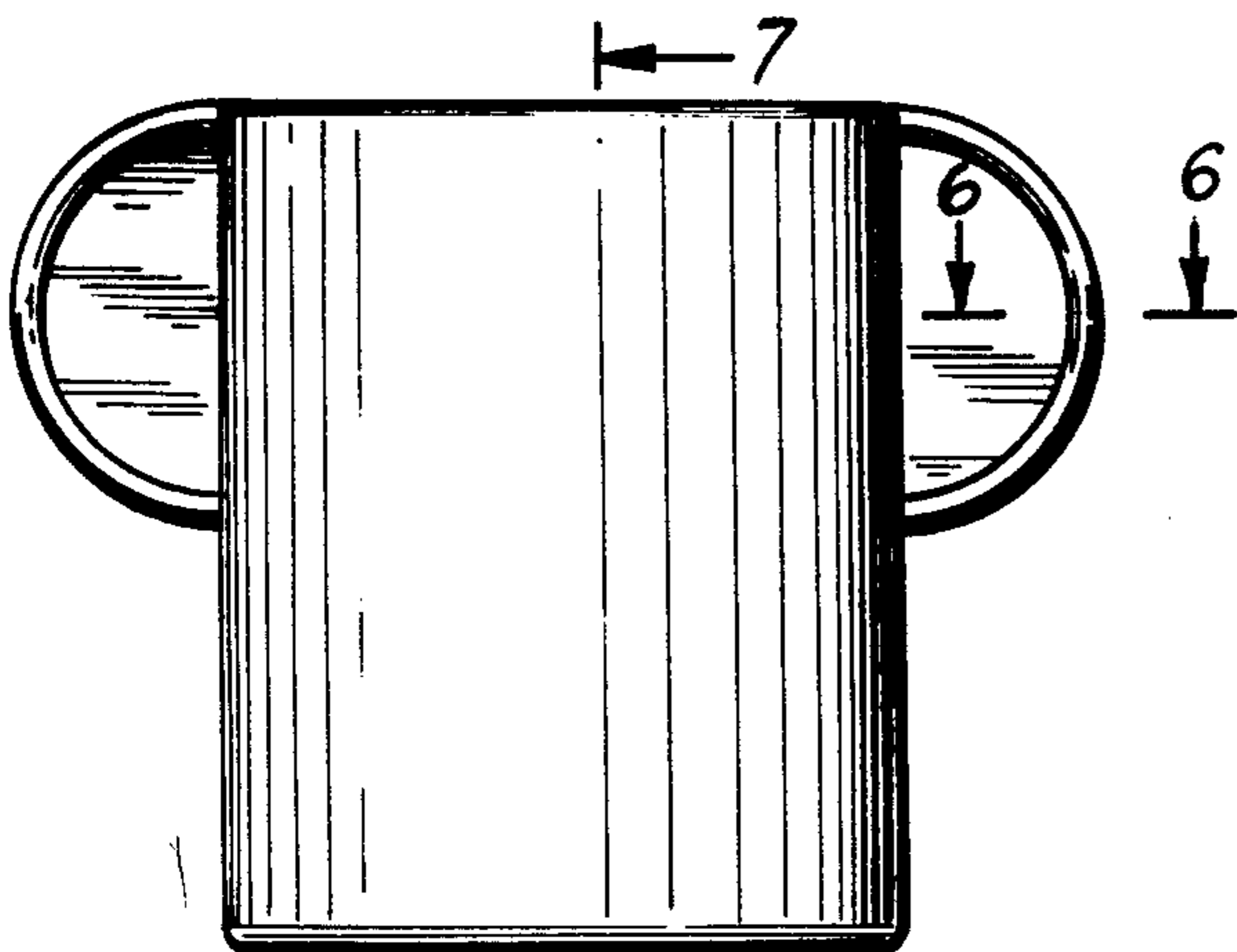

FIG. 4



FIG. 6



FIG. 7