

[54] TOOL KIT CASE

[75] Inventor: Roger W. Wheeler, Reading, Mich.

[73] Assignee: Vaco Products Company

[**] Term: 14 Years

[21] Appl. No.: 860,490

[22] Filed: Dec. 14, 1977

[51] Int. Cl. D3-02

[52] U.S. Cl. D3/74

[58] Field of Search D3/30, 74, 75, 99;
206/372-378; D8/DIG. 7, 83-85; D9/222

[56] References Cited

U.S. PATENT DOCUMENTS

D. 167,868 9/1952 Selikoff et al. D3/74

OTHER PUBLICATIONS

Vaco Cat. No. SD.-200 © 1976, p. 24, Item #70103.

Primary Examiner—George P. Word
Attorney, Agent, or Firm—Max Dressler

[57] CLAIM

The ornamental design for a tool kit case, substantially as shown and described.

DESCRIPTION

FIG. 1 is a perspective view of a tool kit case showing my new design;

FIG. 2 is a rear elevational view thereof;

FIG. 3 is a left end elevational view thereof;

FIG. 4 is a top plan view thereof;

FIG. 5 is a bottom plan view thereof; and

FIG. 6 is a perspective view of the tool kit case in an open condition.

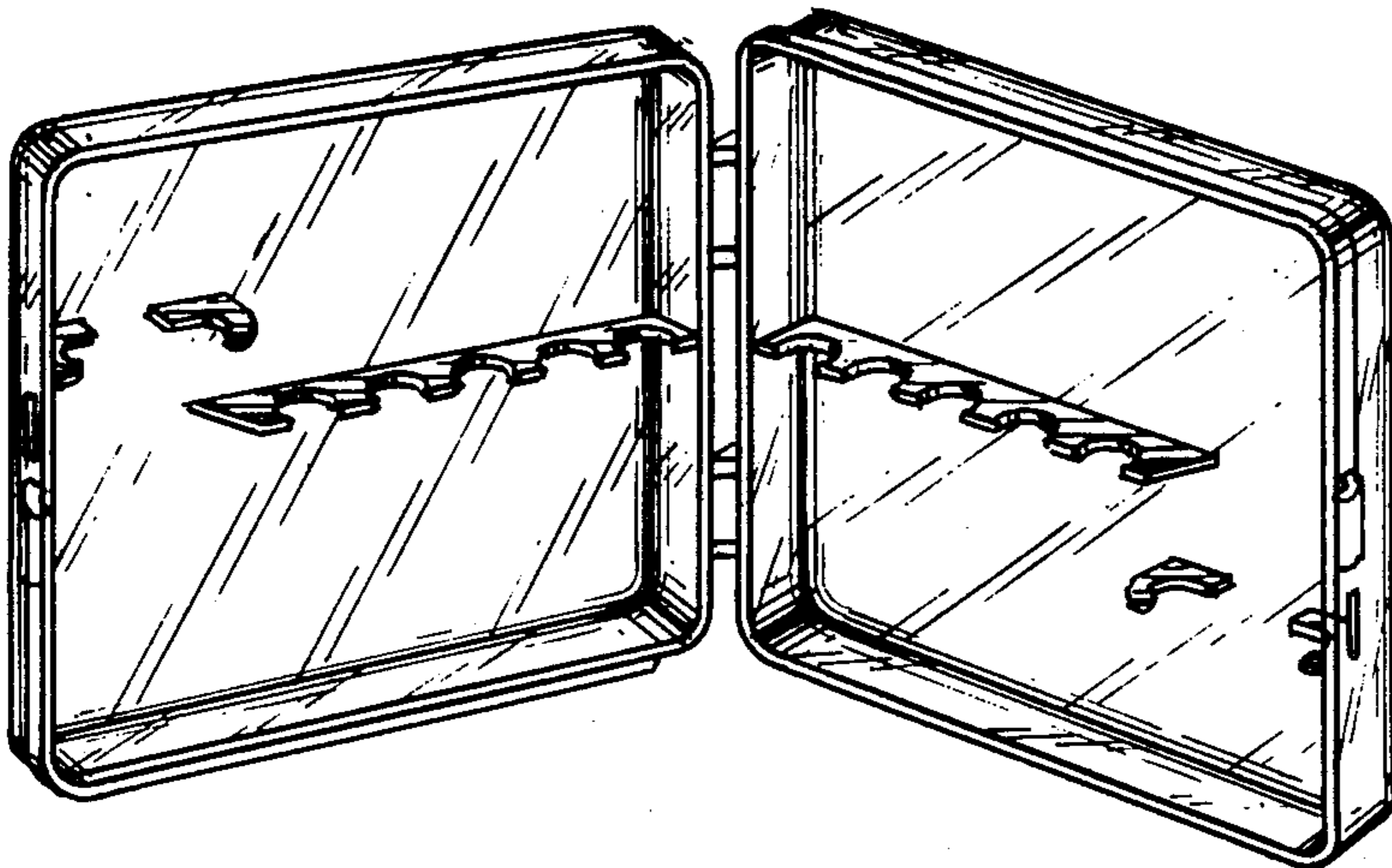
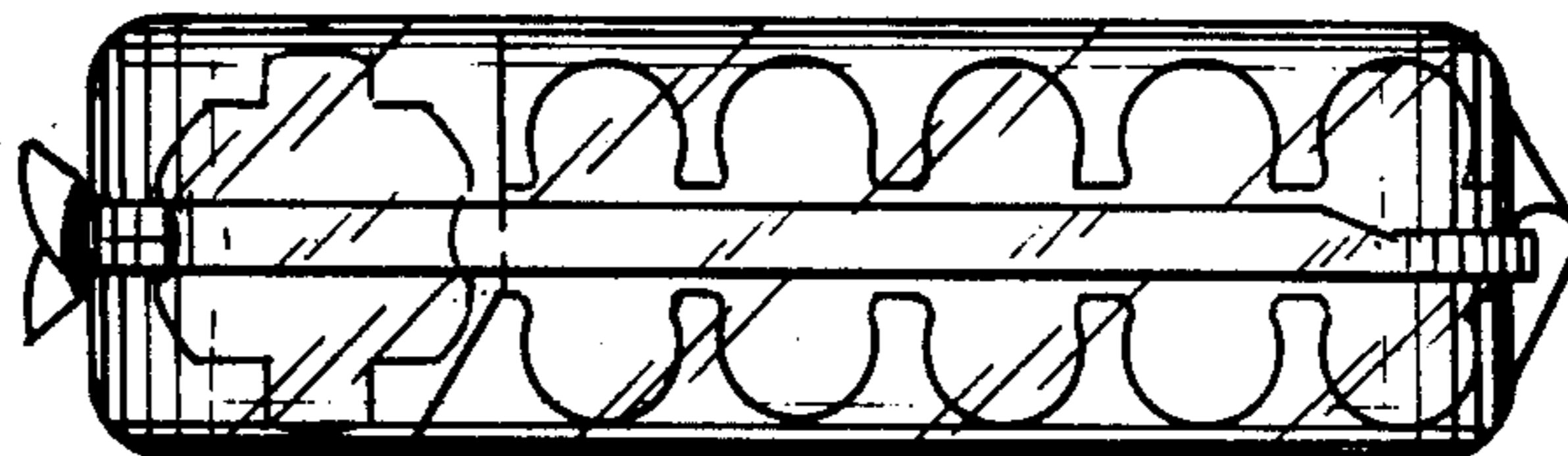

FIG. 1.

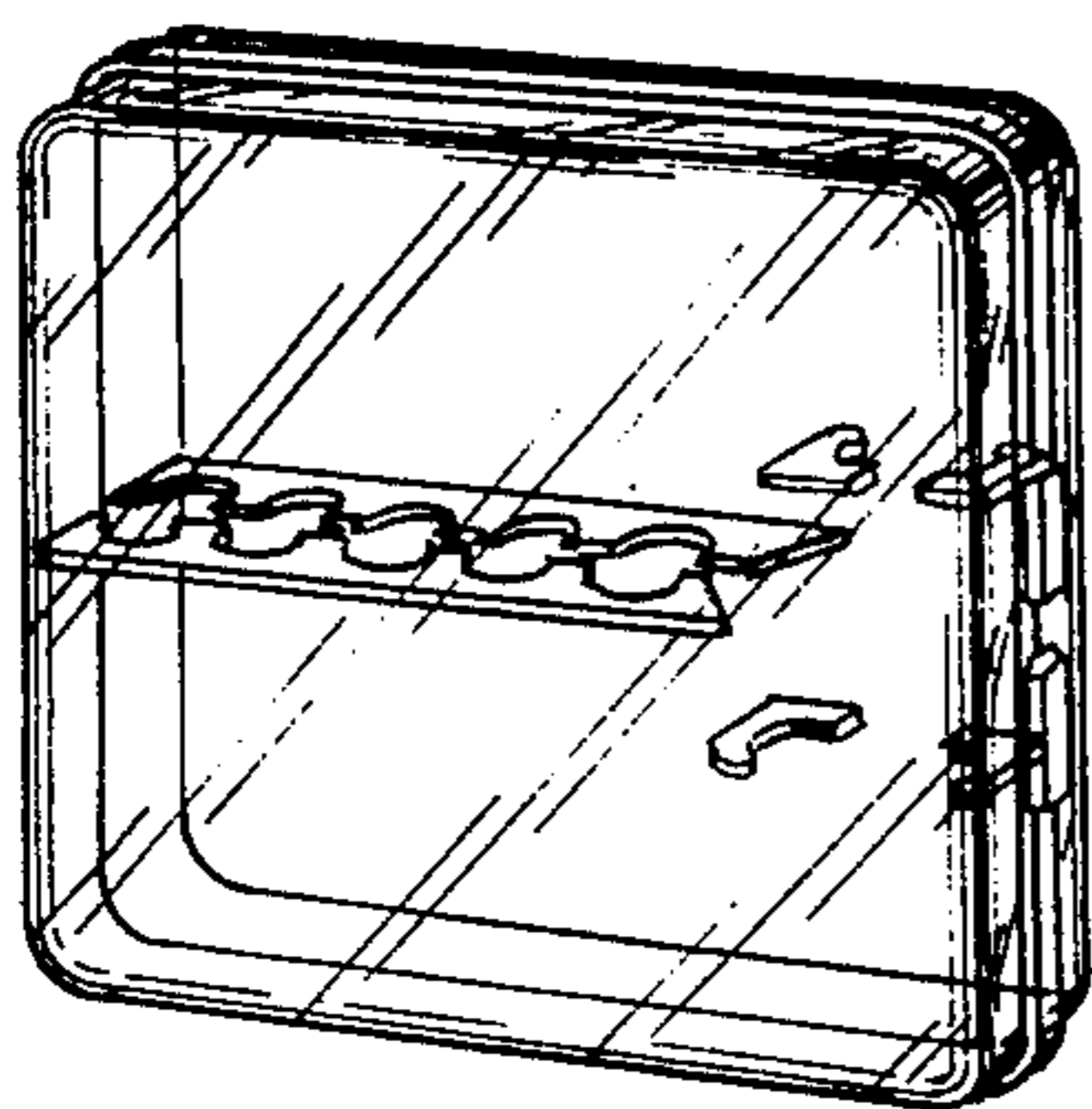

FIG. 2.

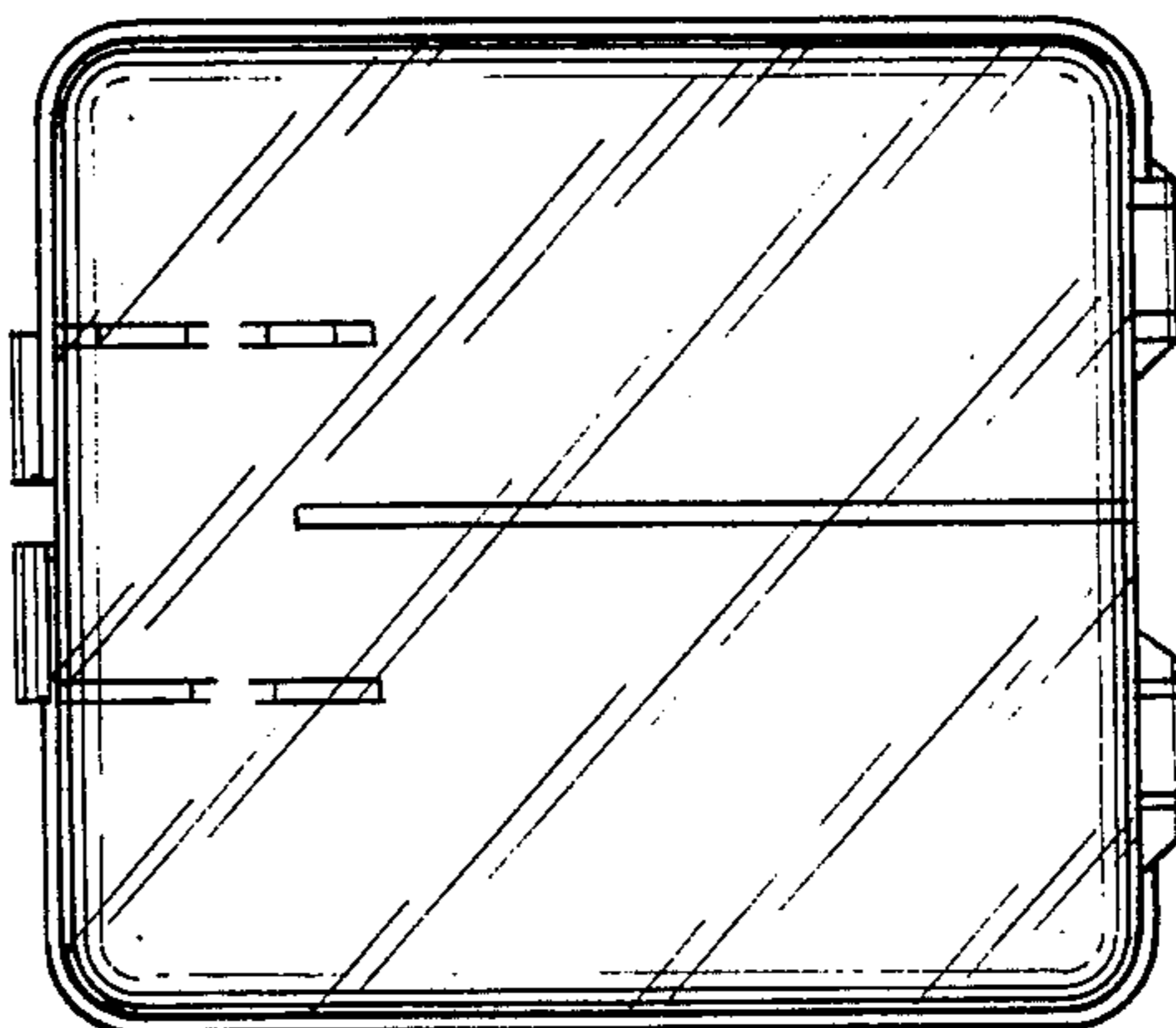

FIG. 3.

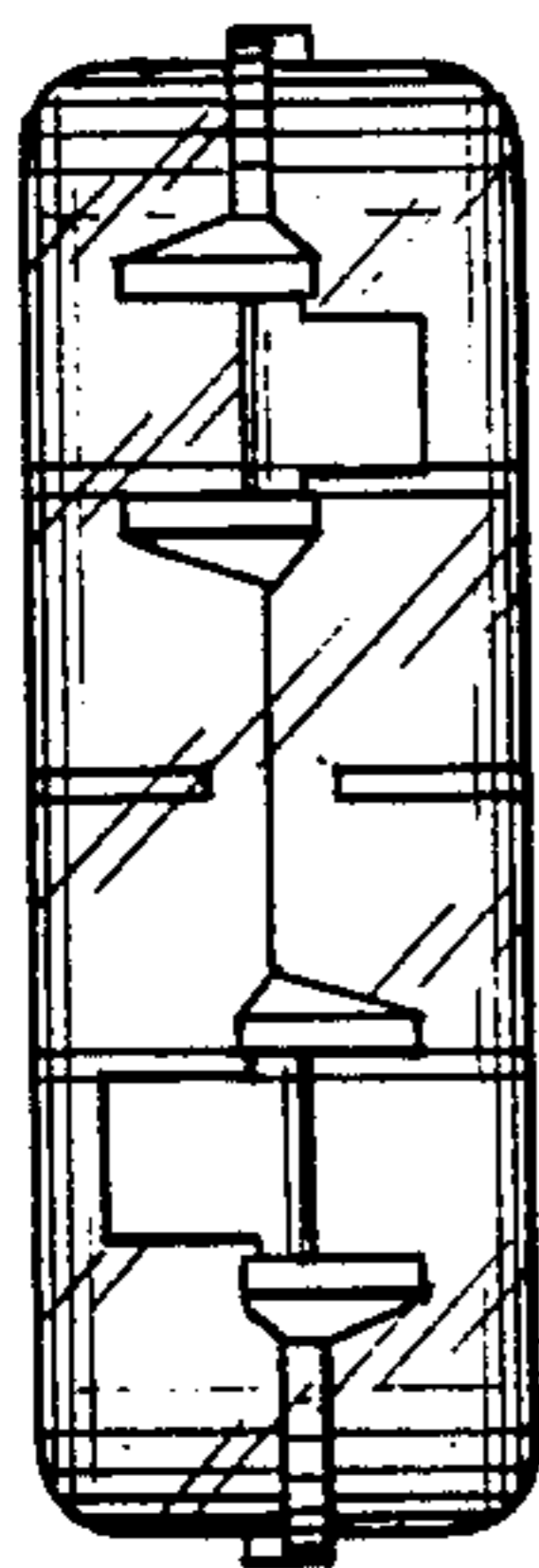

FIG. 4.

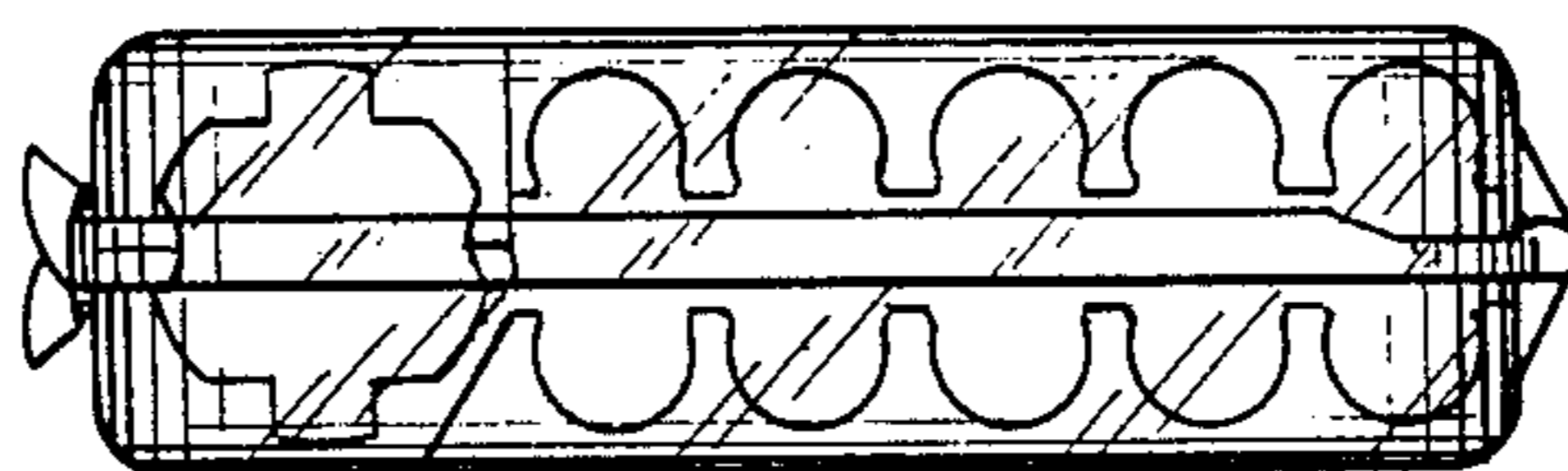

FIG. 5.

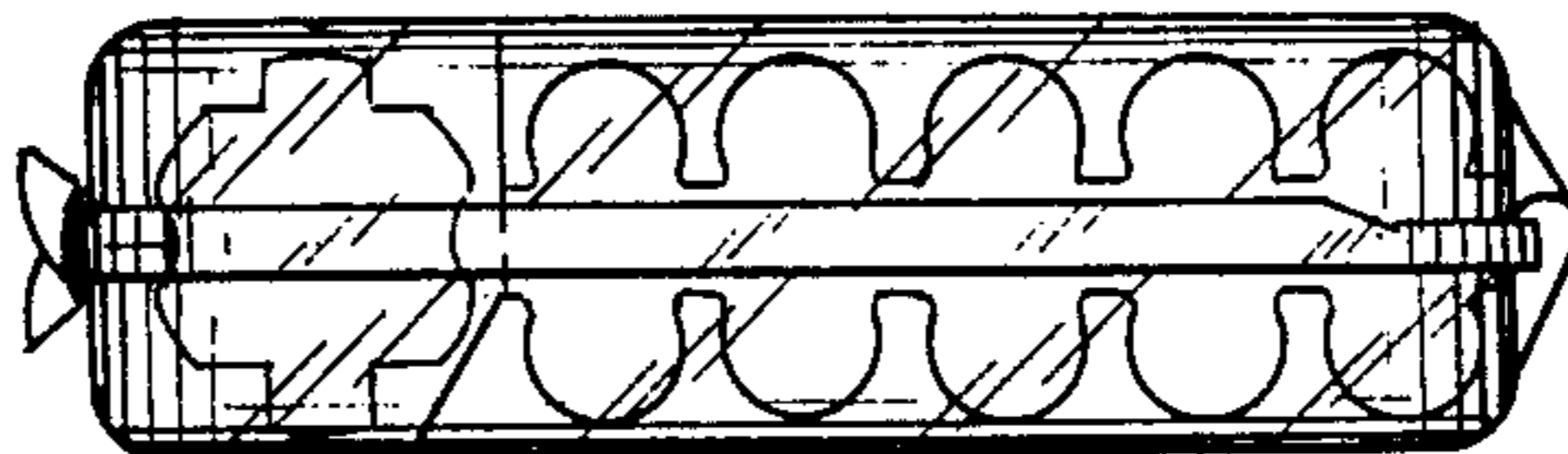

FIG. 6.

