

[54] CHILD TOILET TRAINING CENTER

[76] Inventor: Doris J. Johnson, 8301 S. 88th Ave.,
4 Hickory Trace Dr., Bldg. 26, Apt.
116, Chicago, Ill. 60458

[**] Term: 14 Years

[21] Appl. No.: 879,820

[22] Filed: Feb. 21, 1978

Related U.S. Application Data

[63] Continuation-in-part of Ser. No. 726,657, Sep. 27, 1976.

[51] Int. Cl. D23-02

[52] U.S. Cl. D23/53

[58] Field of Search D23/48-53;
4/9, 112, 113, 134, 138, 141, 142, 145, 185 B,
185 S; D6/5, 7

[56] References Cited

U.S. PATENT DOCUMENTS

D. 164,748	10/1951	Webster	D6/7
D. 212,472	10/1968	Von Hech	D23/53
D. 225,224	11/1972	Benjamin	D23/53
2,776,438	1/1957	Zeraffa	4/134
4,069,522	1/1978	Messmer et al.	4/141 X

Primary Examiner—James R. Largen
Attorney, Agent, or Firm—James P. Hume

[57] CLAIM

The design for a child toilet training center, substantially as shown.

DESCRIPTION

FIG. 1 is a perspective view of child-toilet training center showing my new design.
FIG. 2 is a top plan view thereof;
FIG. 3 is a front elevational view thereof;
FIG. 4 is a side elevational view thereof;
FIG. 5 is a rear elevational view thereof;
FIG. 6 is a bottom view thereof; and
FIG. 7 is a cross-sectional view taken on line 7-7 of FIG. 5.

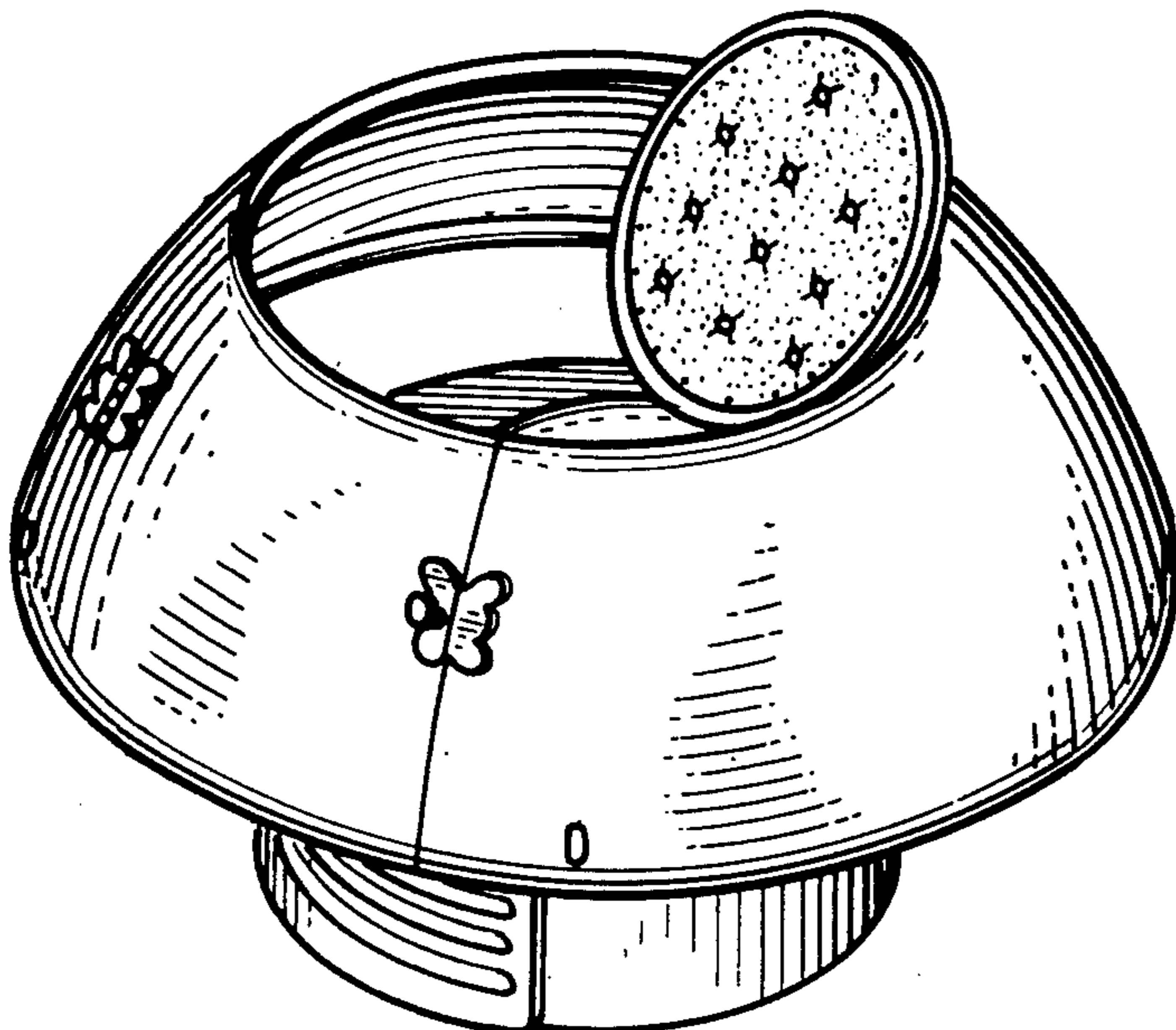

FIG. 1

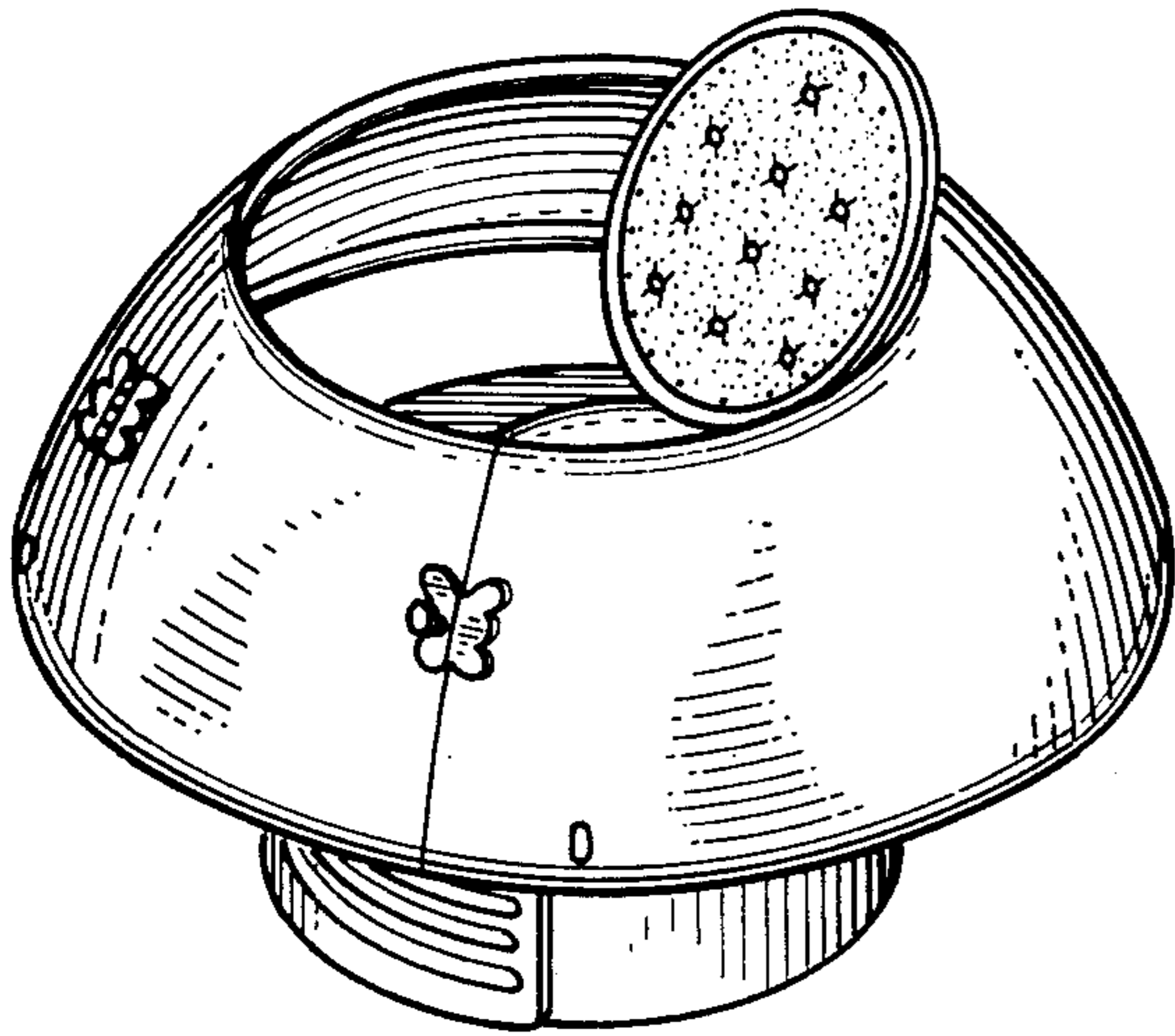

FIG. 2

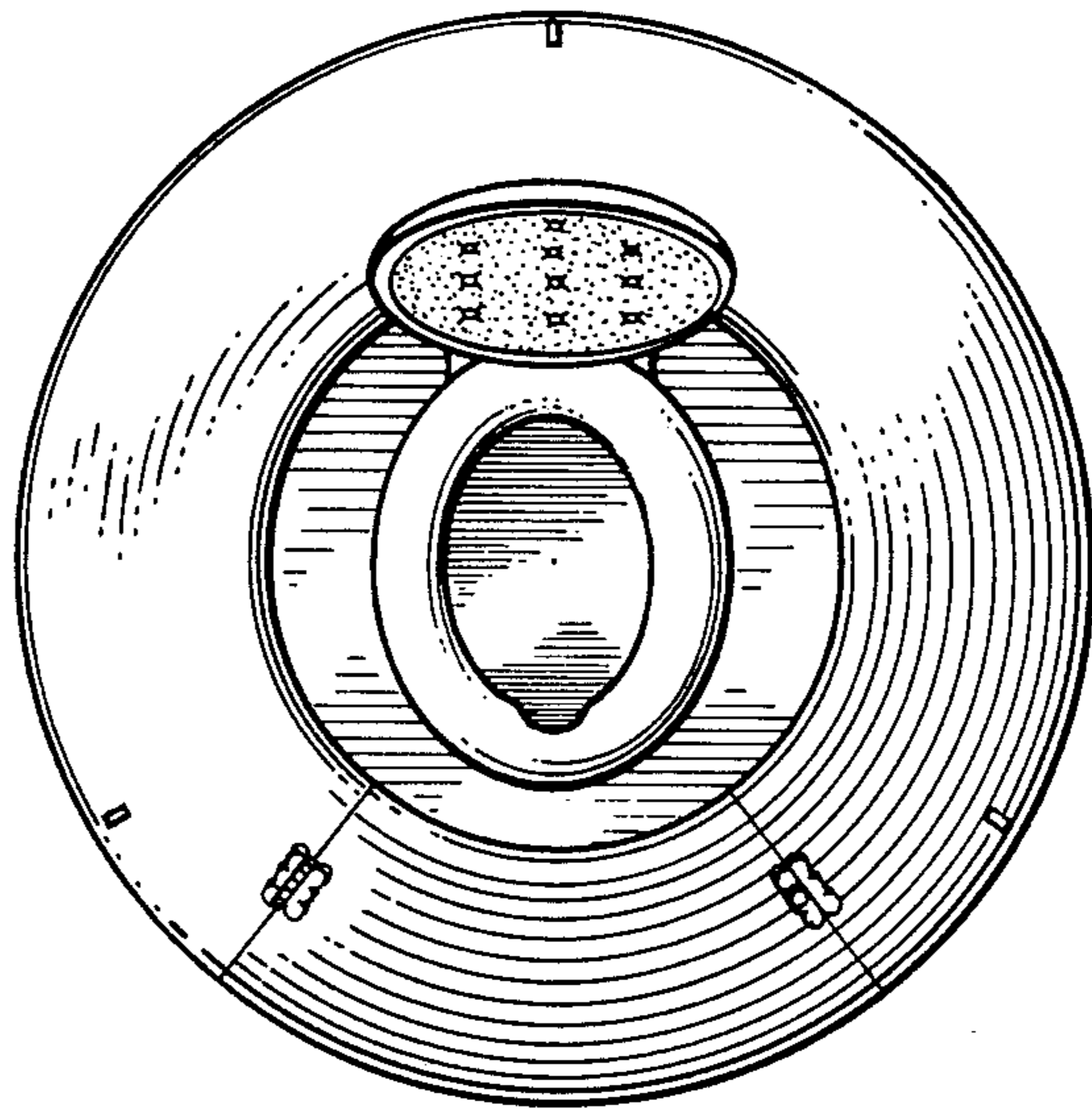

FIG. 3

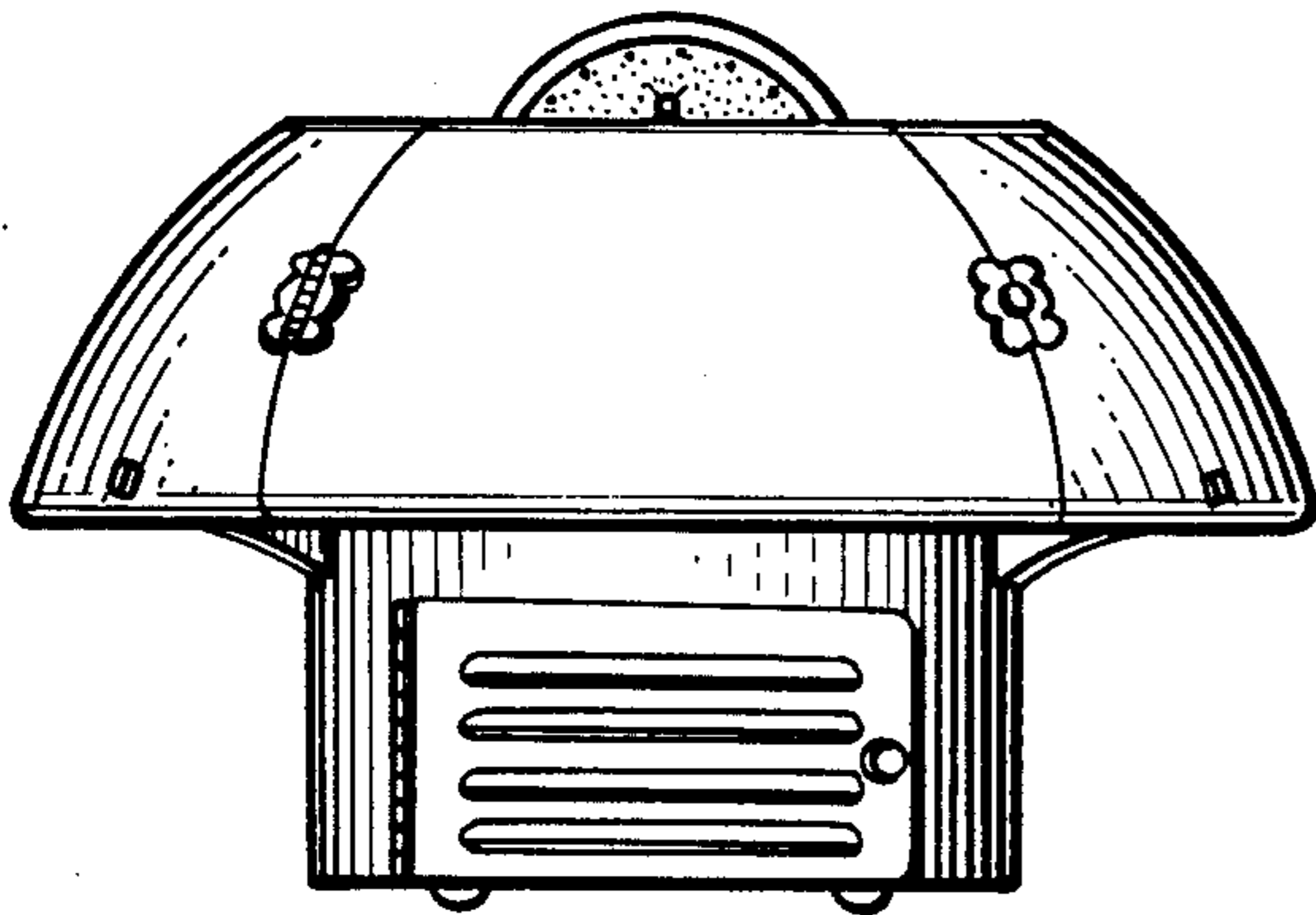

FIG. 4

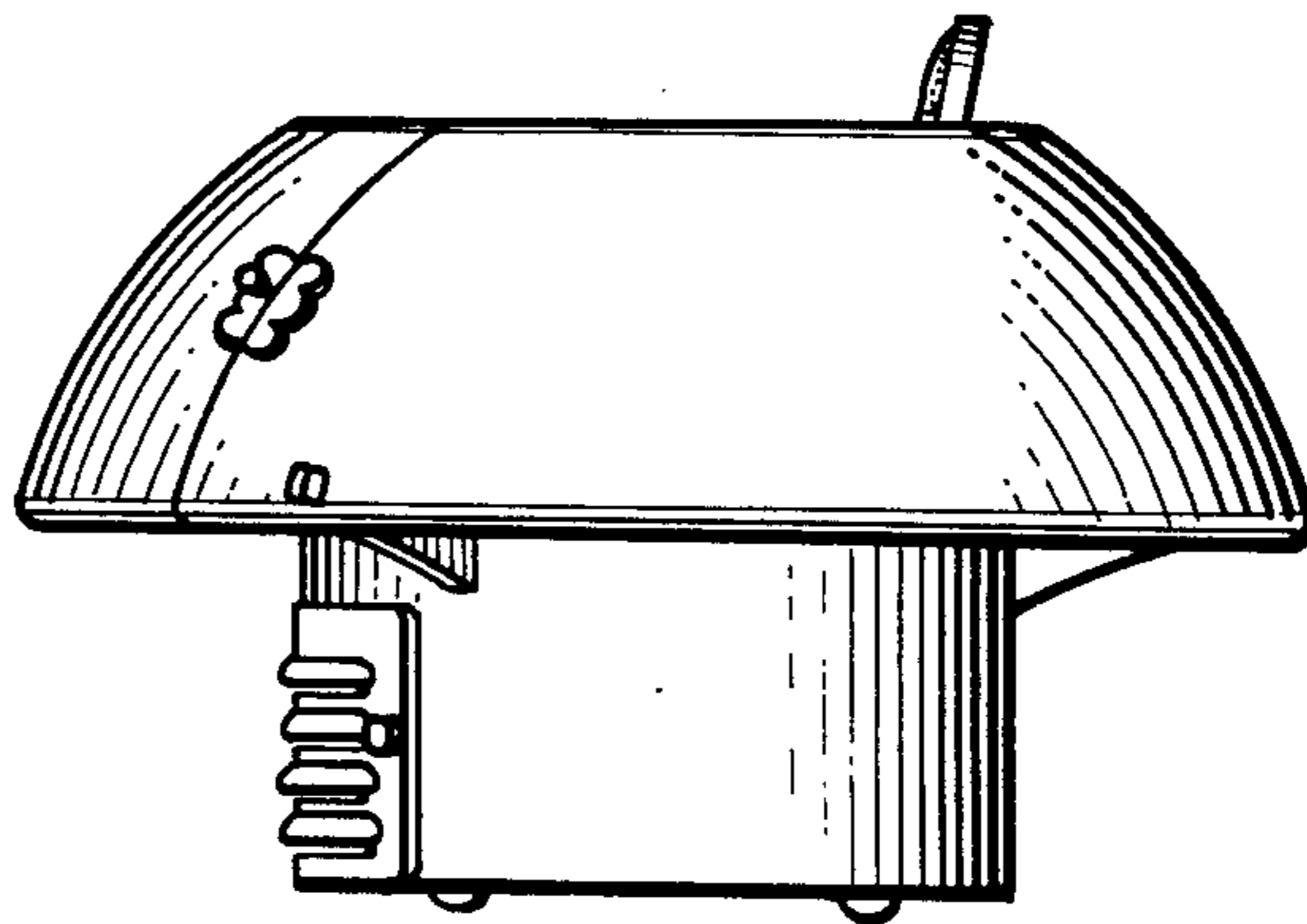

FIG. 5

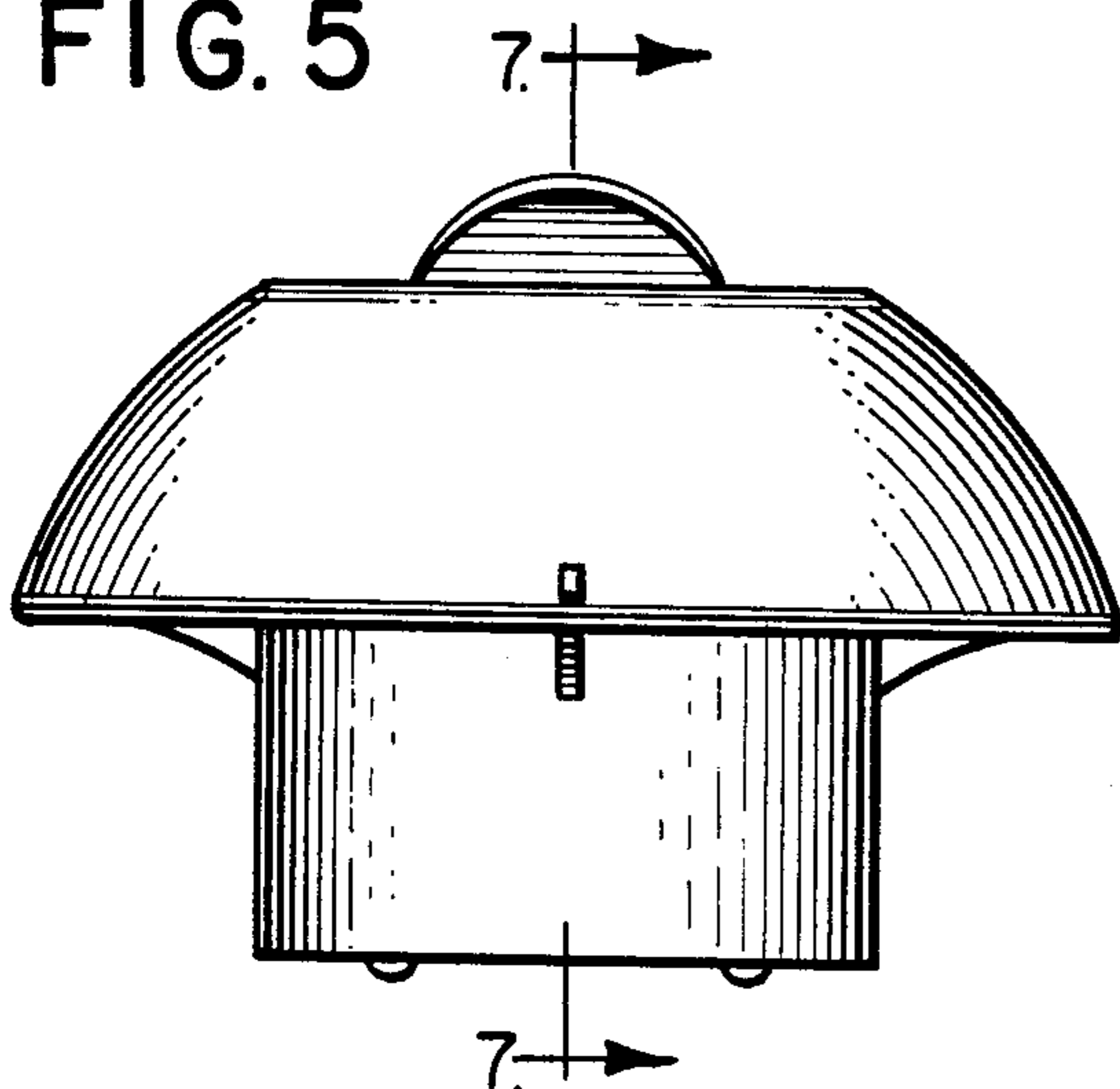
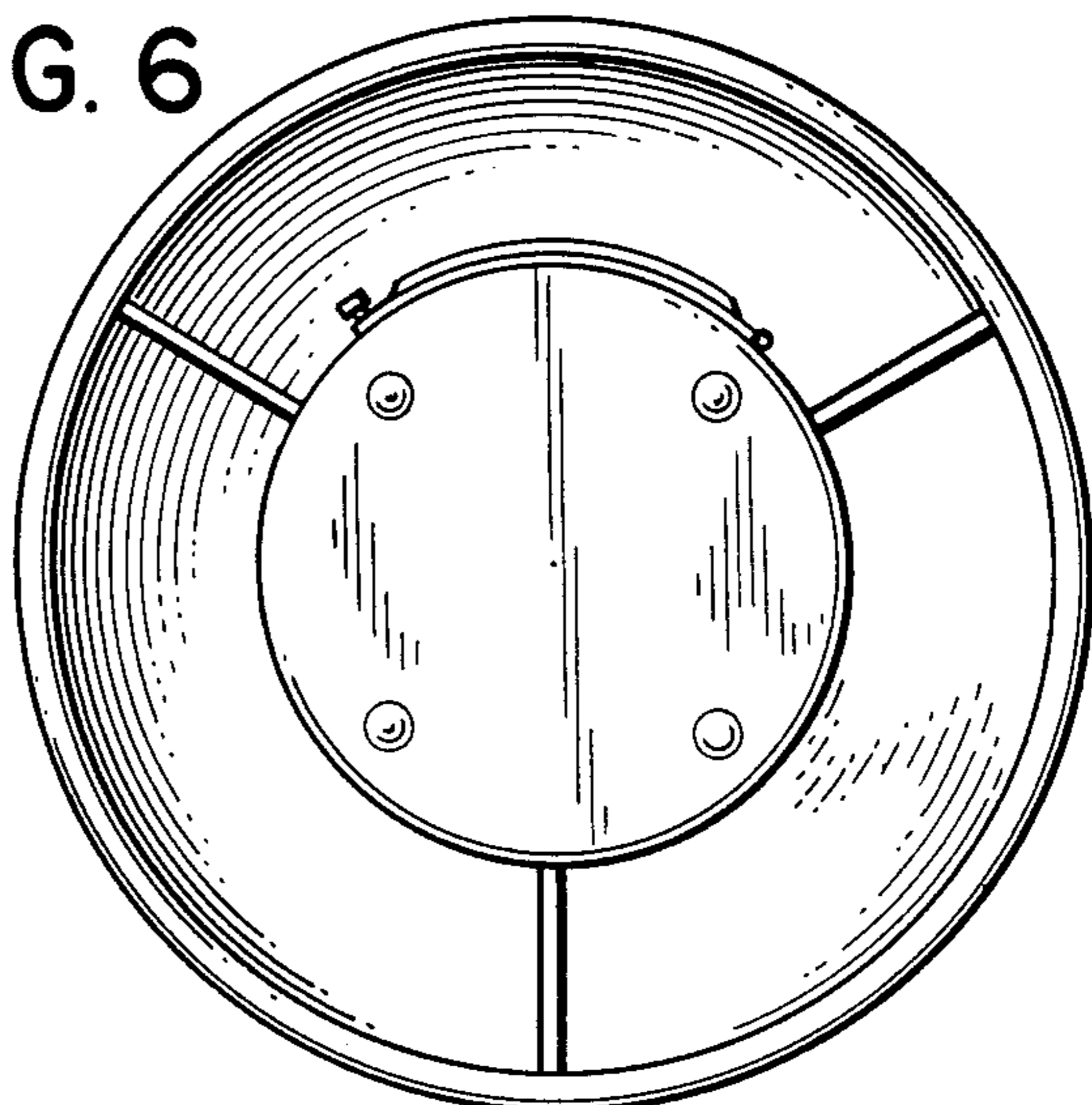

FIG. 6



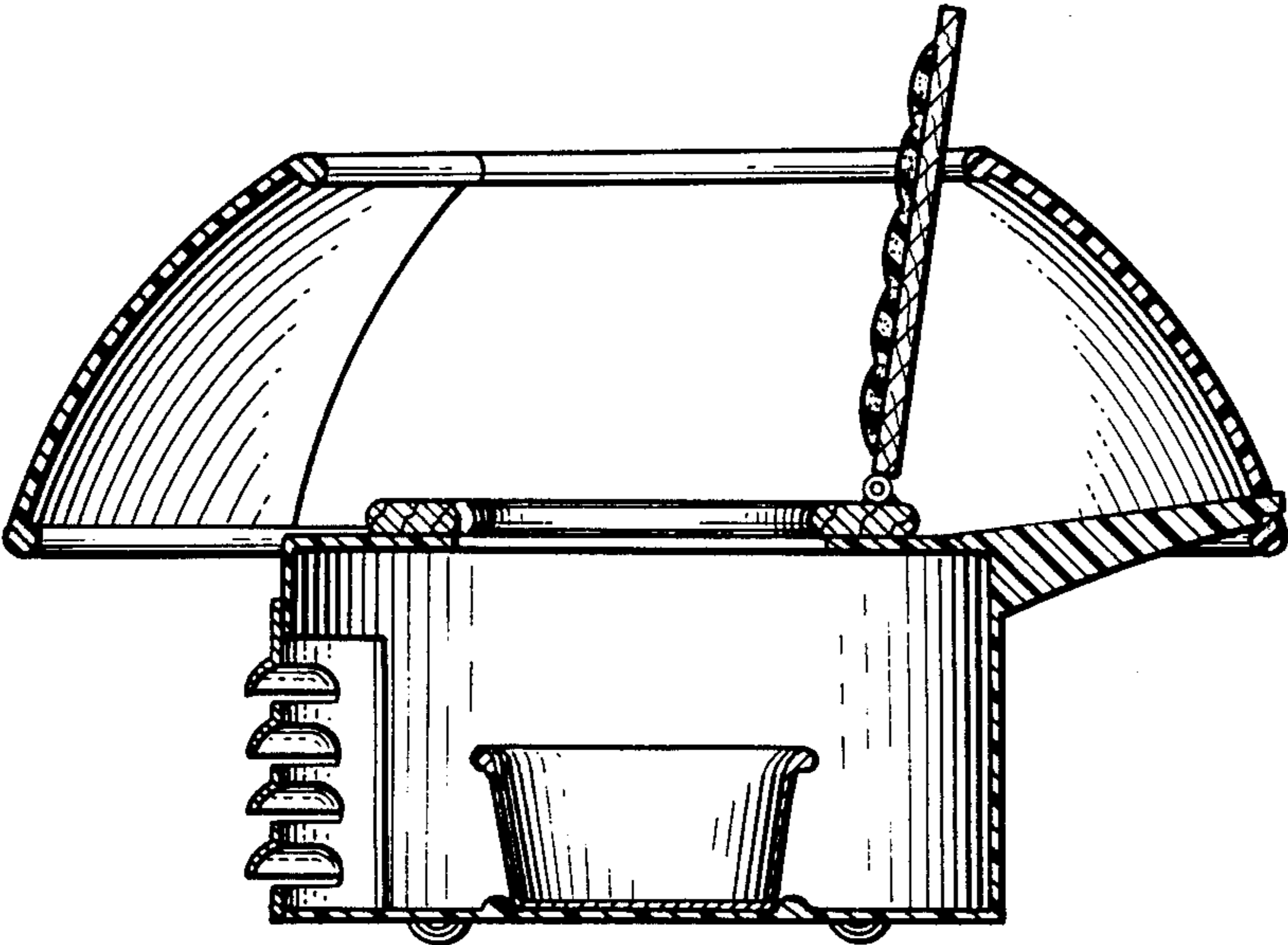

FIG. 7