

[54] **COMBINED TOWEL WARMER AND FABRIC DRYER**

[75] Inventors: **Mary Souhan**, 5543 Emerson St., Dallas, Tex. 75209; **Raymond M. Green, Jr.**, Richardson, Tex.

[73] Assignee: **Mary Souhan**, Dallas, Tex.

[**] Term: **14 Years**

[21] Appl. No.: **945,955**

[22] Filed: **Sep. 26, 1978**

[51] Int. Cl. **D23—03**

[52] U.S. Cl. **D23/77**

[58] Field of Search **D23/77; 219/342, 345, 219/385, 521; 34/151, 239, 243**

[56] **References Cited**

U.S. PATENT DOCUMENTS

D. 246,985	1/1978	Popma et al.	D23/77
2,919,497	1/1960	Konstandt	34/151
3,138,699	6/1964	Taylor	219/521
3,849,629	11/1974	Graham, Jr.	219/342

3,939,574 2/1976 Garot 34/151 X

FOREIGN PATENT DOCUMENTS

43652 7/1938 Netherlands 34/239

Primary Examiner—Catherine E. Kemper
Attorney, Agent, or Firm—Arthur H. Seidel

[57] **CLAIM**

The ornamental design for a combined towel warmer and fabric dryer, substantially as shown and described.

DESCRIPTION

FIG. 1 is a front perspective view of a combined towel warmer and fabric dryer, showing our new design; FIG. 2 is a rear perspective view thereof; FIG. 3 is a plan view of two sides thereof; FIG. 4 is an elevational view of one of the three sides thereof; FIG. 5 is an elevational view of another of the three sides thereof; FIG. 6 is an elevational view of the third side thereof; FIG. 7 is a front elevational view thereof; FIG. 8 is a rear elevational view thereof.

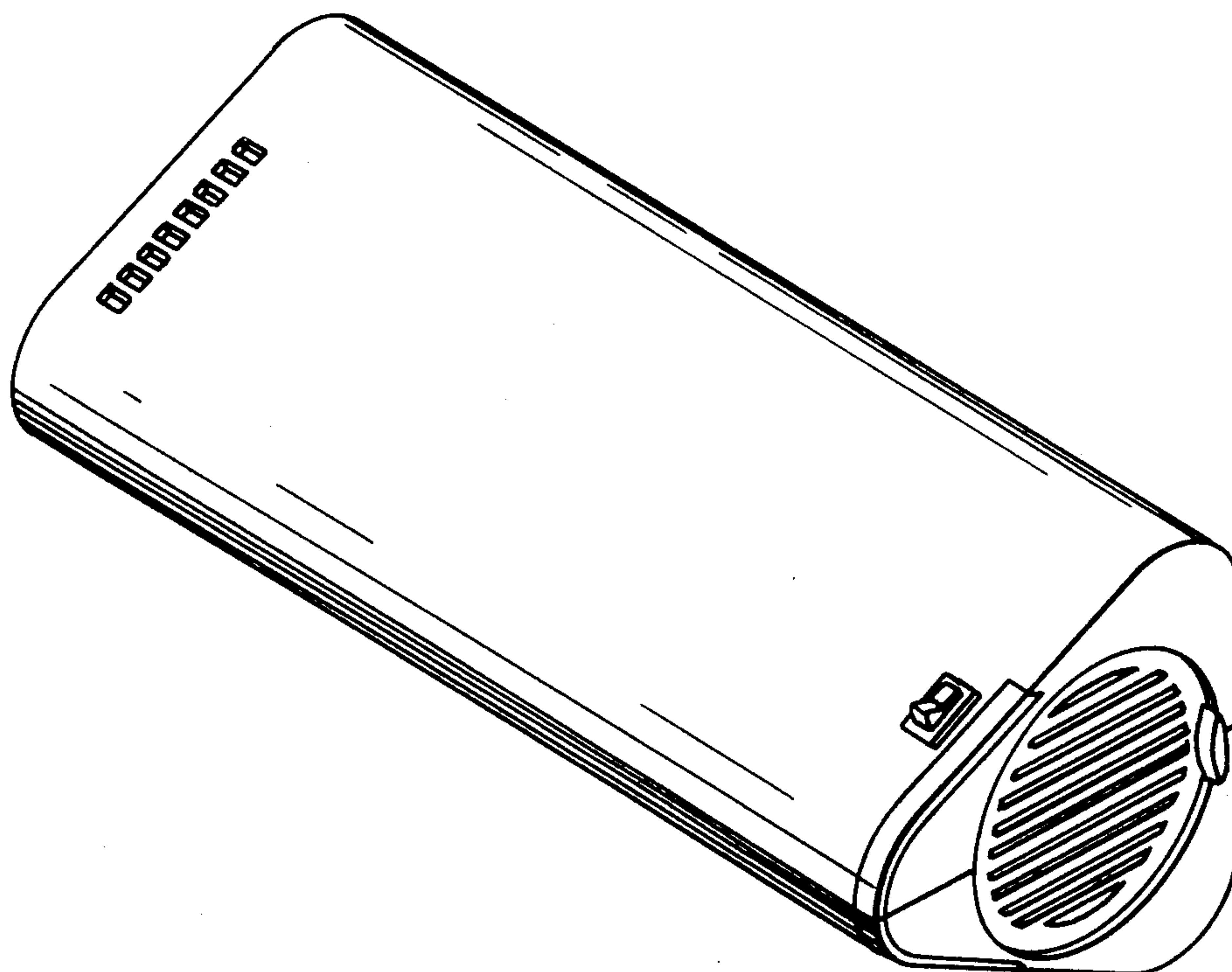

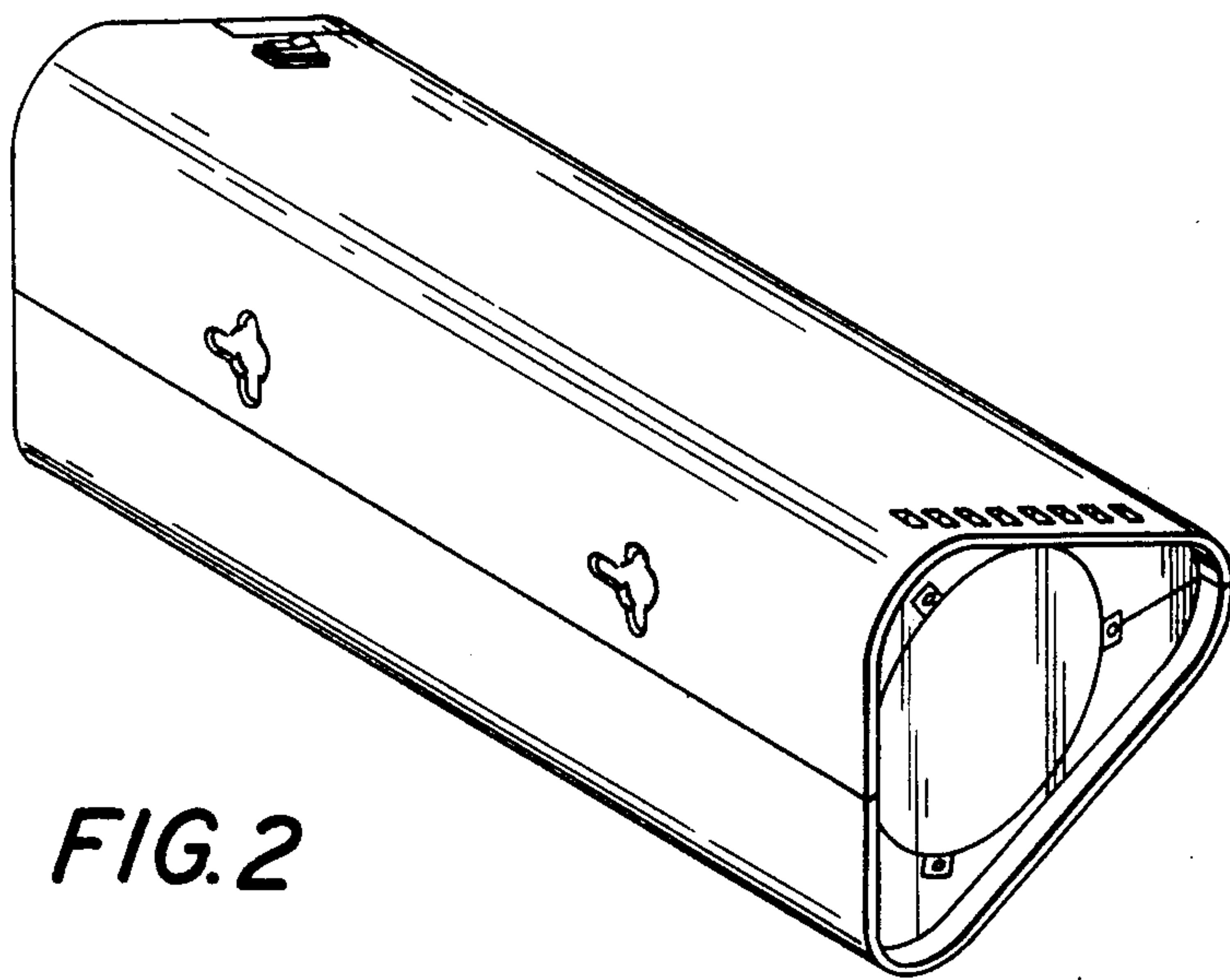
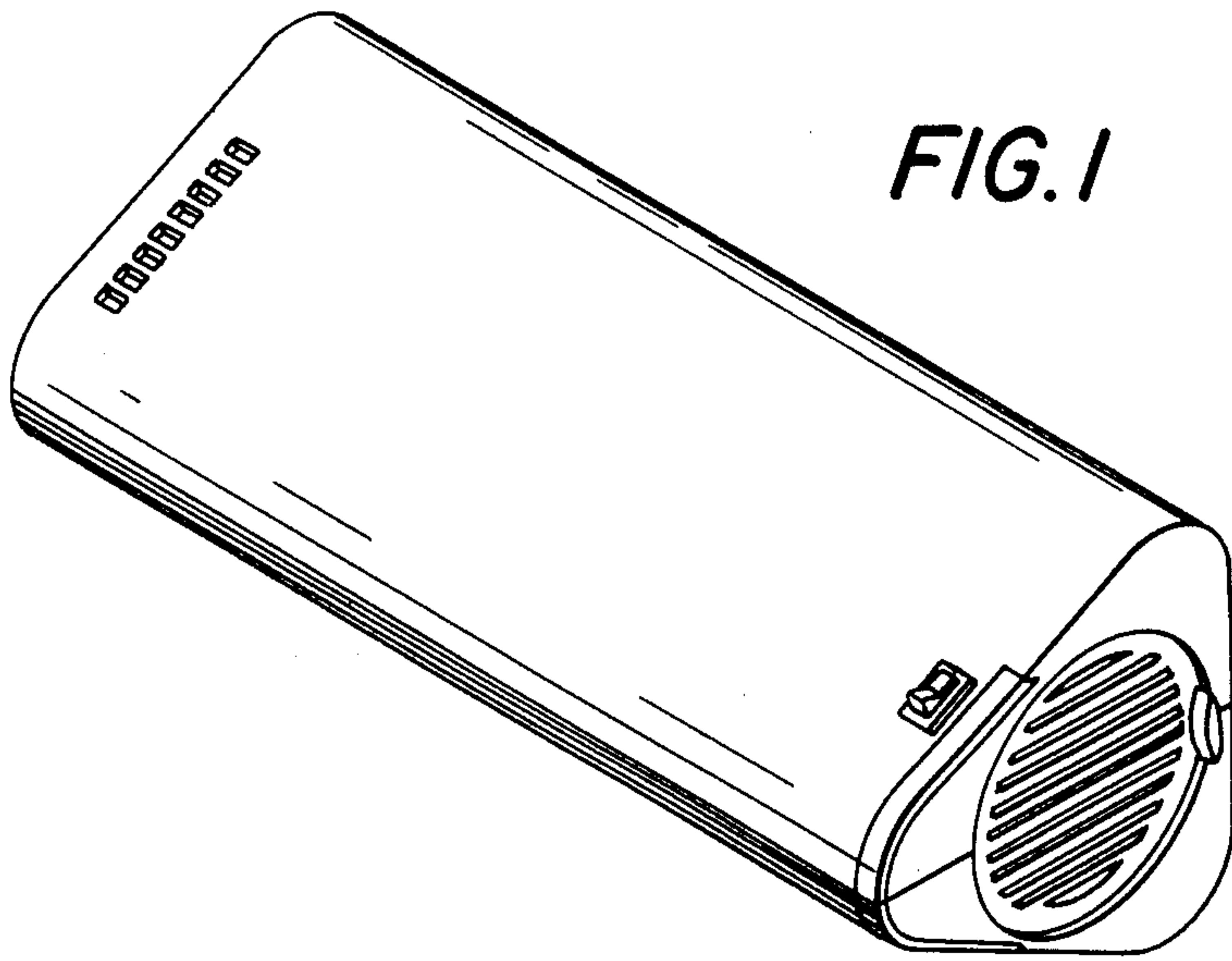

FIG. 3

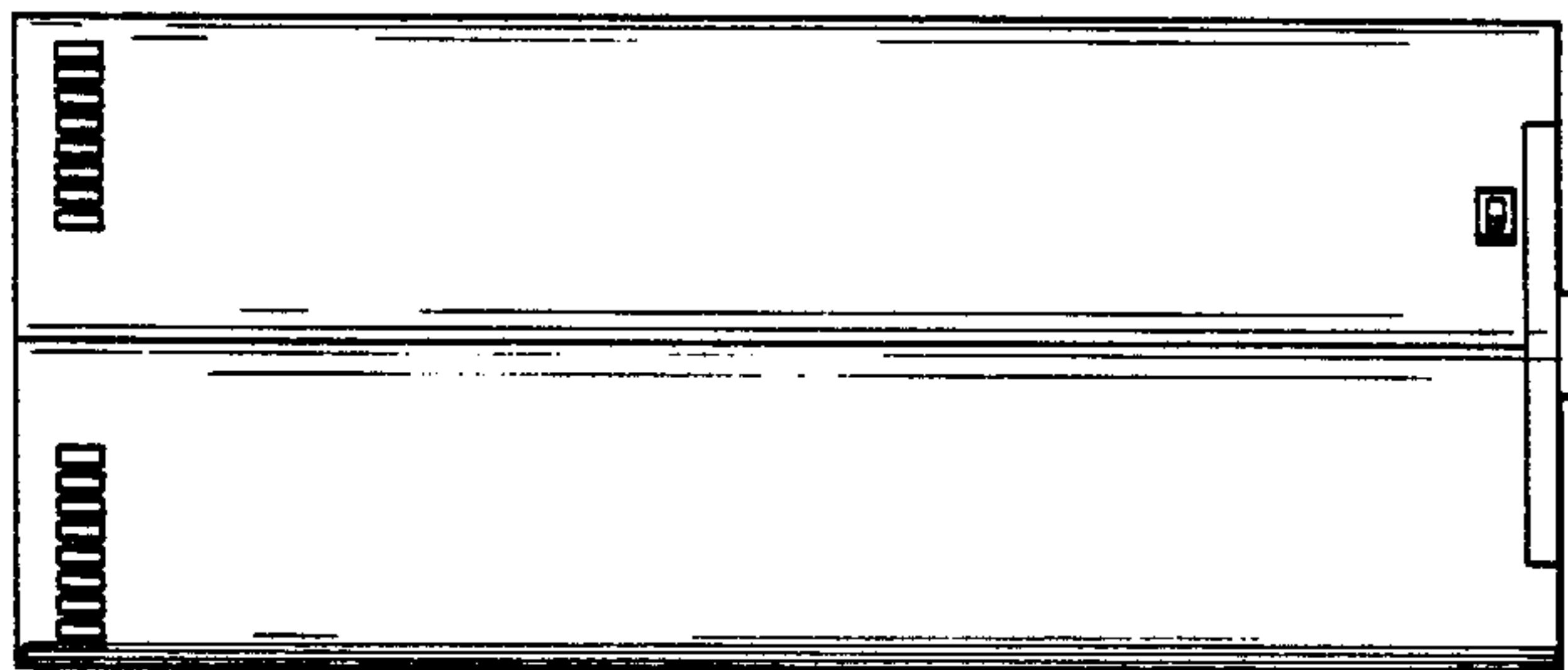

FIG. 4

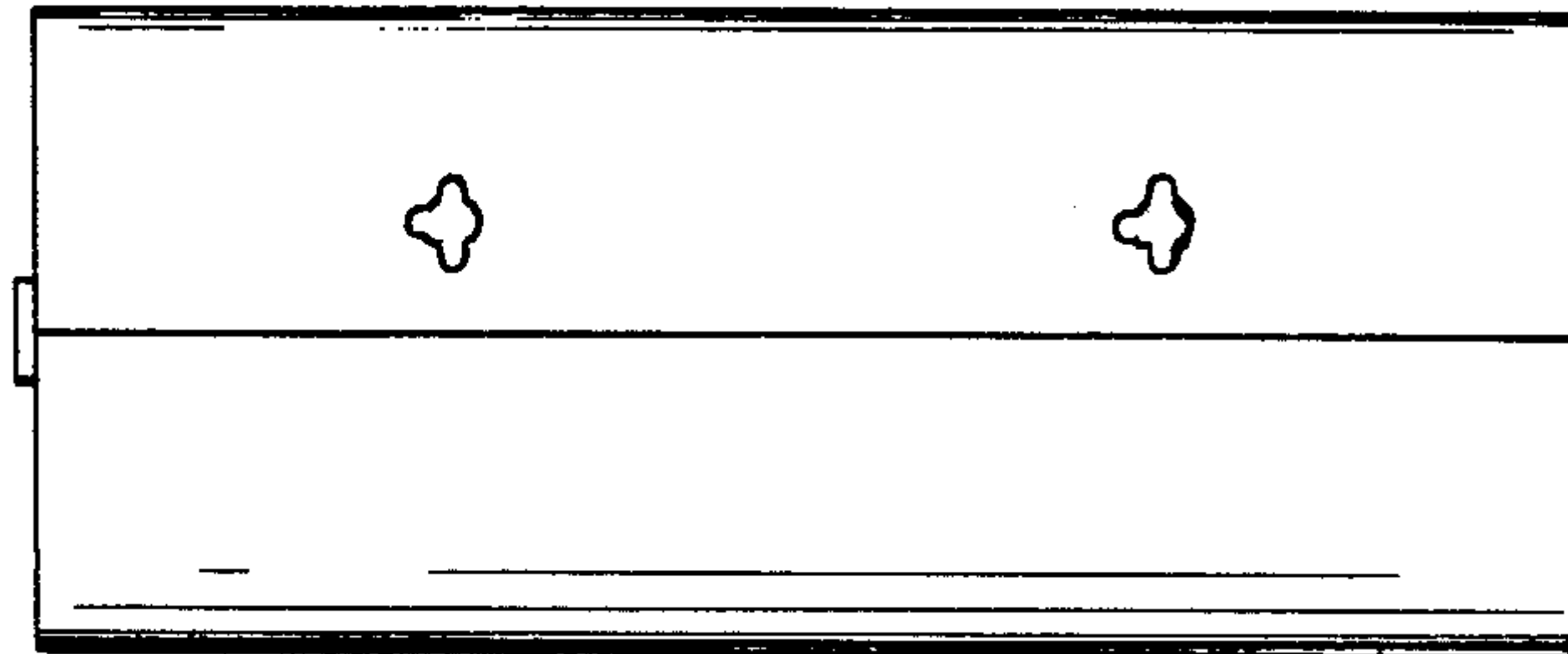

FIG. 5

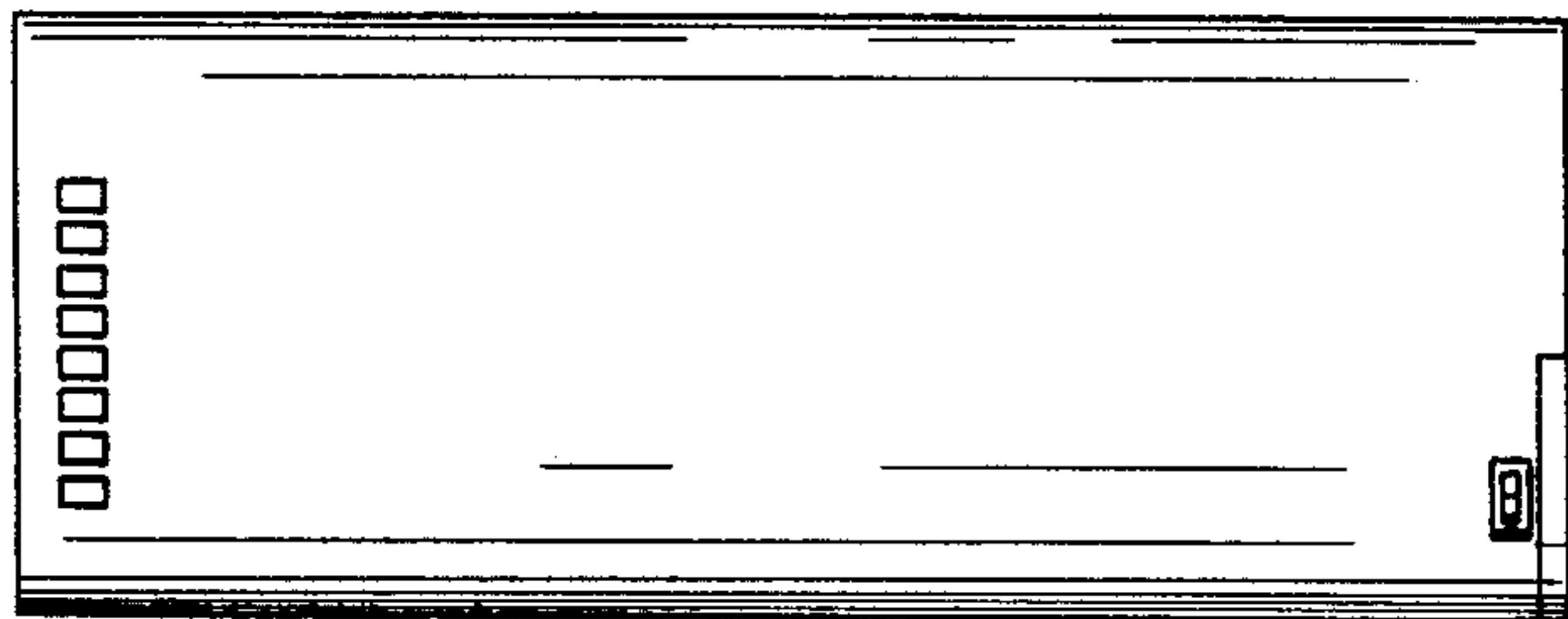

FIG. 6

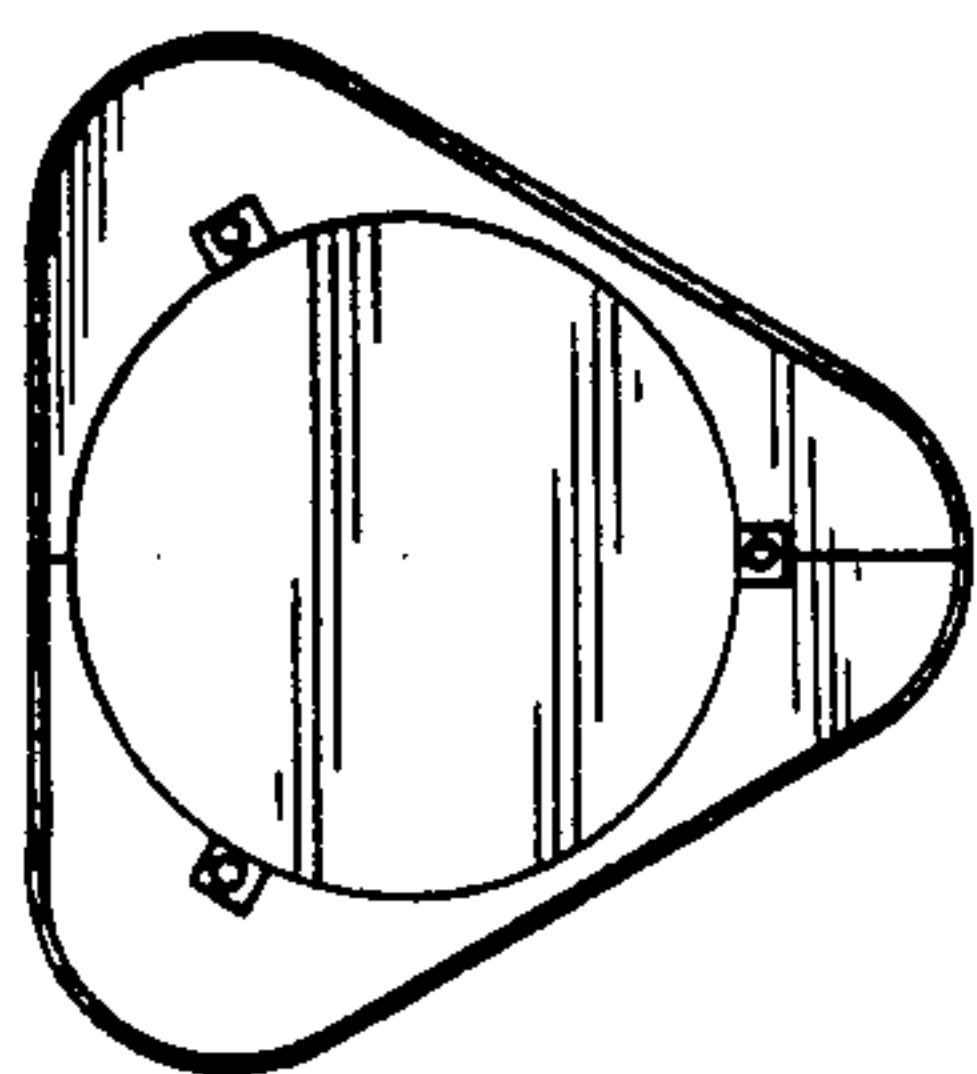
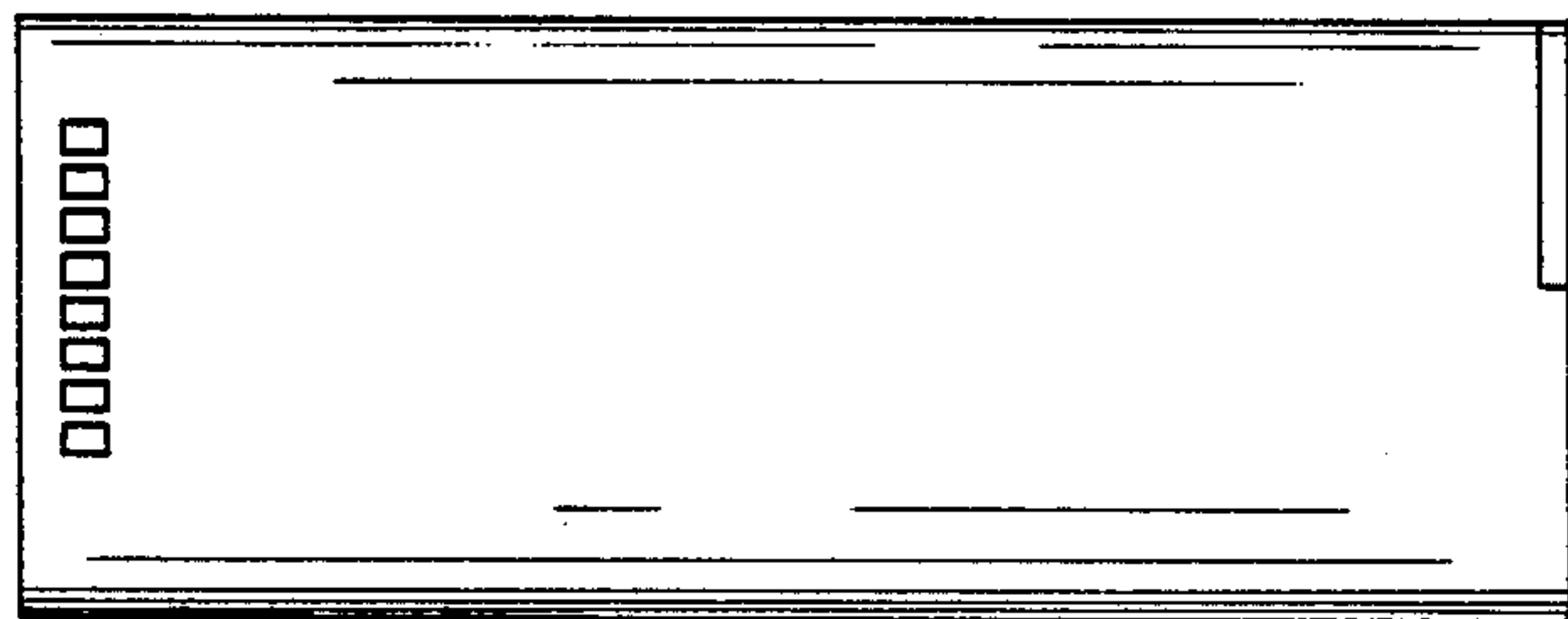

FIG. 8

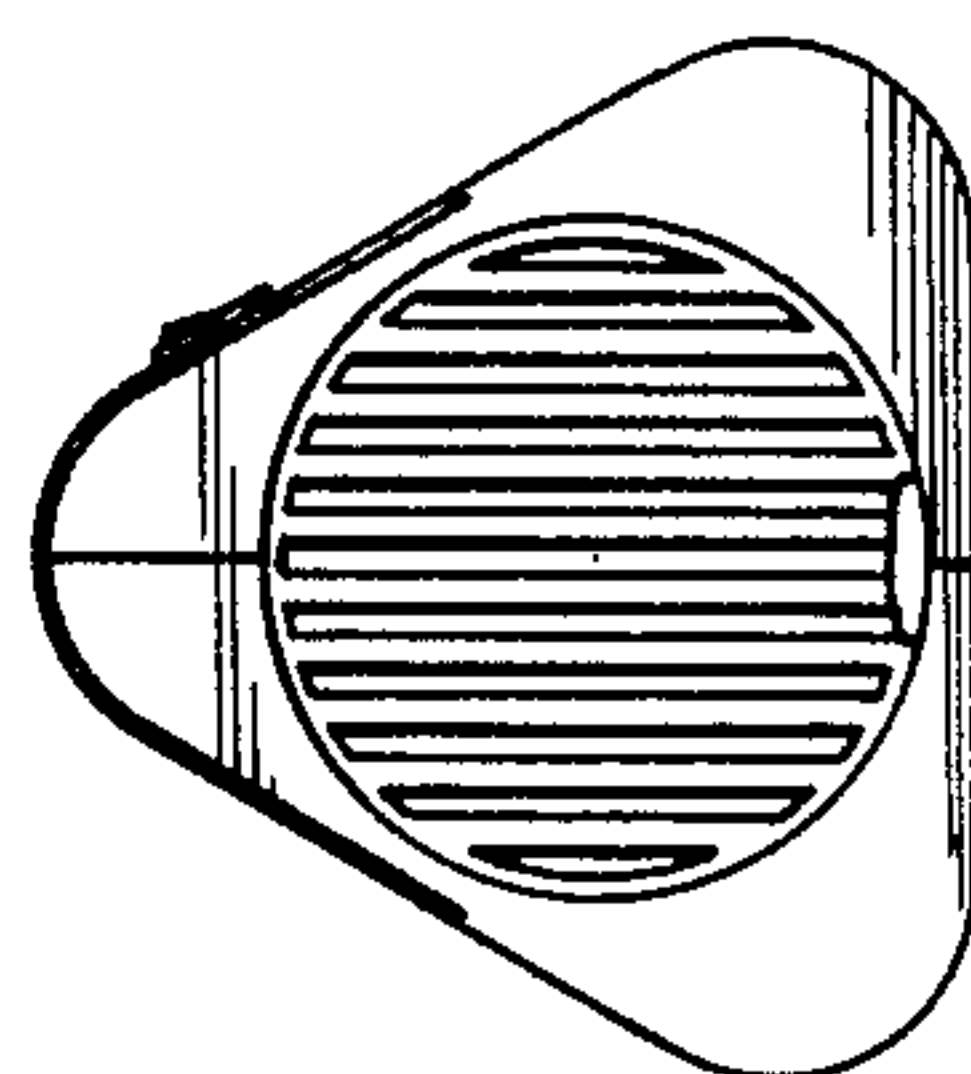

FIG. 7