

[54] INK-RIBBON CASSETTE

[75] Inventors: Osamu Nakamura, Shiojiri; Kaoru Iida, Suwa, both of Japan

[73] Assignee: Kabushiki Kaisha Suwa Seikosha

[**] Term: 14 Years

[21] Appl. No.: 949,521

[22] Filed: Oct. 10, 1978

[30] Foreign Application Priority Data

Apr. 11, 1978 [JP] Japan 53-14417

[51] Int. Cl. D18-01

[52] U.S. Cl. D18/12

[58] Field of Search D18/12, 22; D14/11; 400/196, 196.1, 207, 208, 208.1

[56] References Cited

U.S. PATENT DOCUMENTS

D. 234,633	3/1975	Dellim	D14/11 X
D. 253,354	11/1979	Lenney et al.	D18/12
3,960,259	6/1976	Guerrini et al.	400/208
4,188,134	2/1980	Garrido	400/208

Primary Examiner—Louis S. Zarfaz
Attorney, Agent, or Firm—Robert E. Burns

[57] CLAIM

The ornamental design for an ink-ribbon cassette, substantially as shown and described.

DESCRIPTION

FIG. 1 is a perspective view of an ink-ribbon cassette showing our new design;
FIG. 2 is a top plan view thereof;
FIG. 3 is a front elevational view thereof;
FIG. 4 is a bottom plan view thereof;
FIG. 5 is a rear elevational view thereof;
FIG. 6 is a right side elevational view thereof; and
FIG. 7 is a left side elevational view thereof.

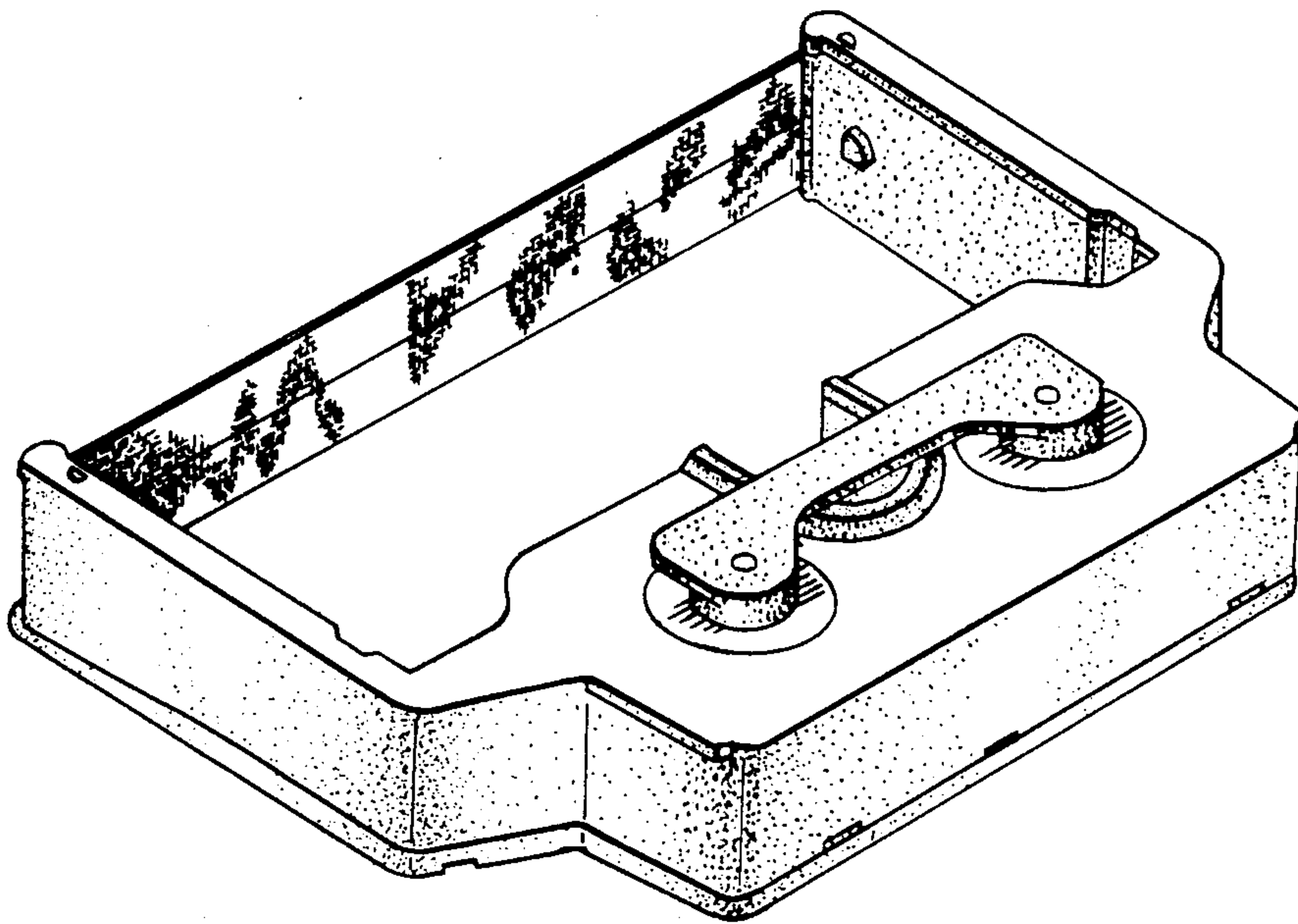

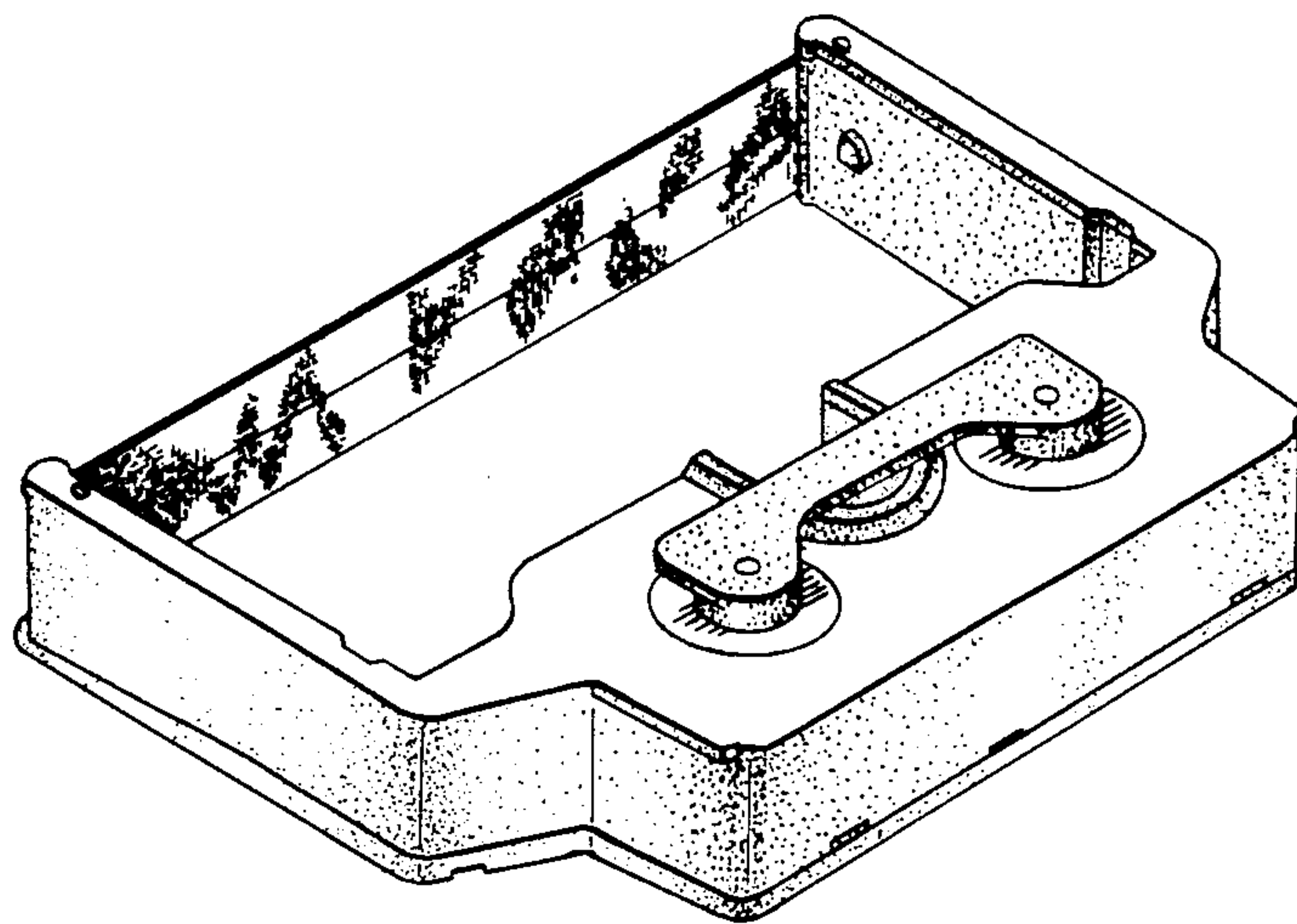

FIG. 1

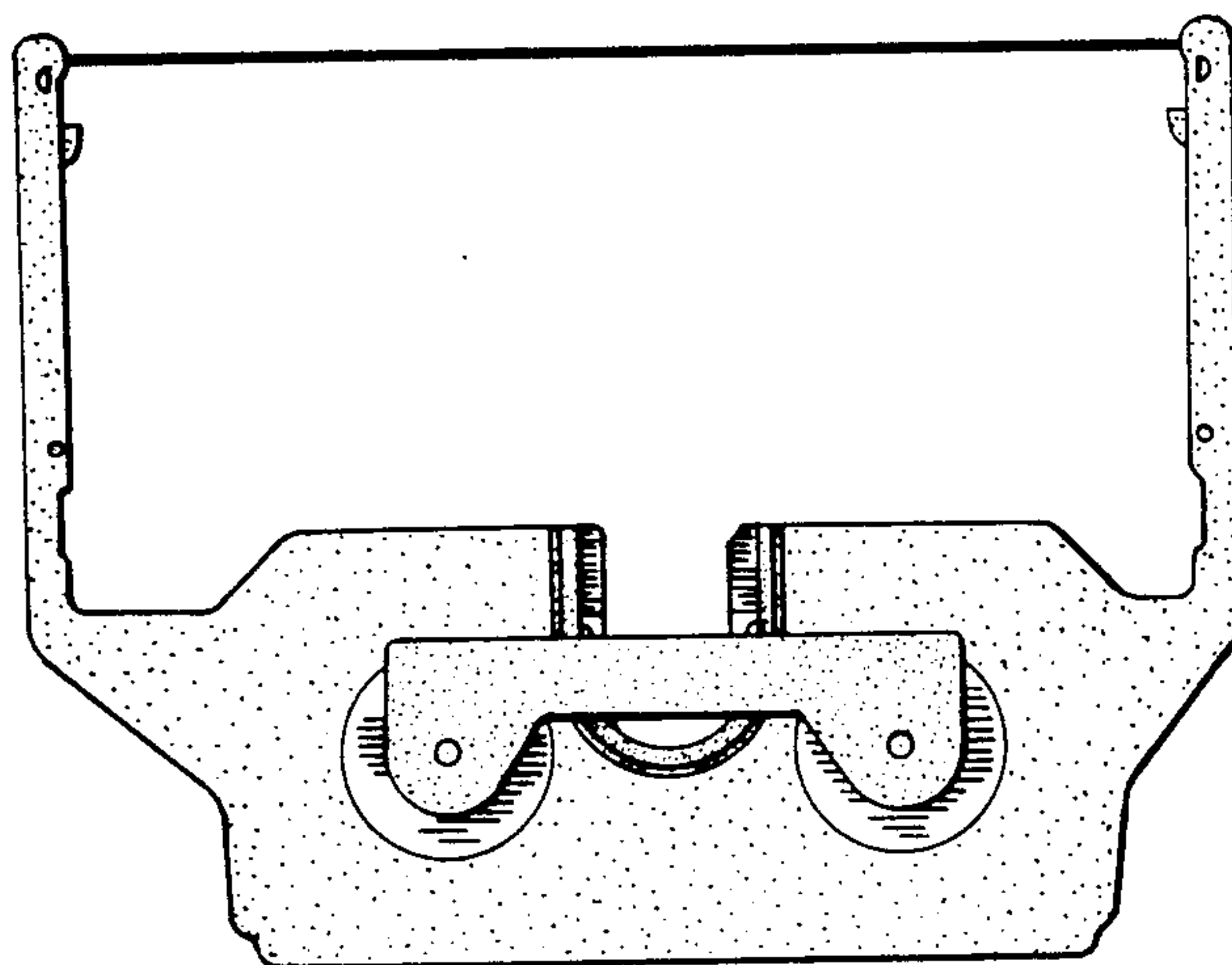

FIG. 2

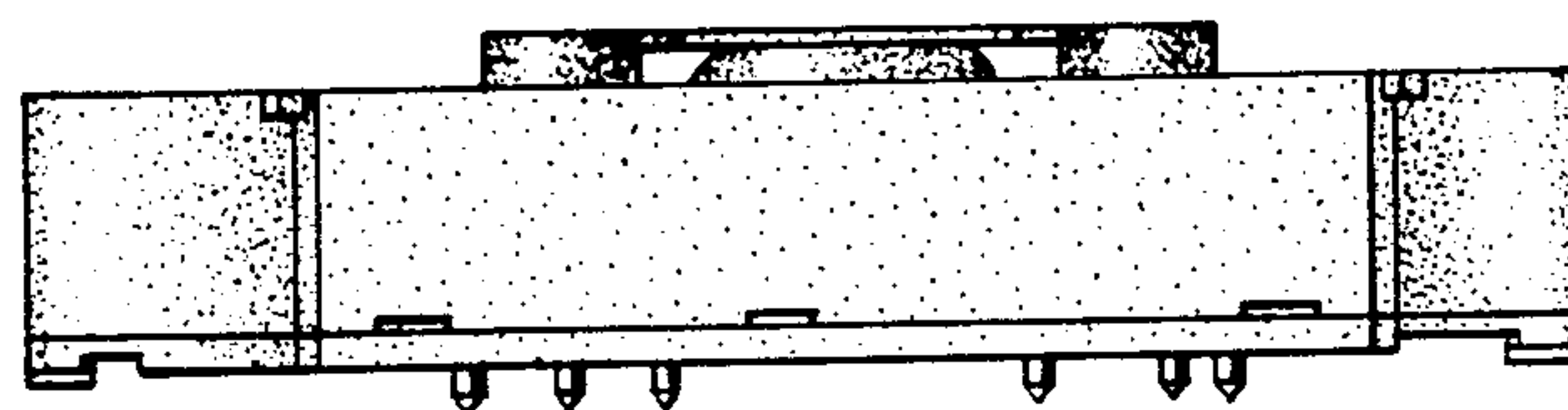

FIG. 3

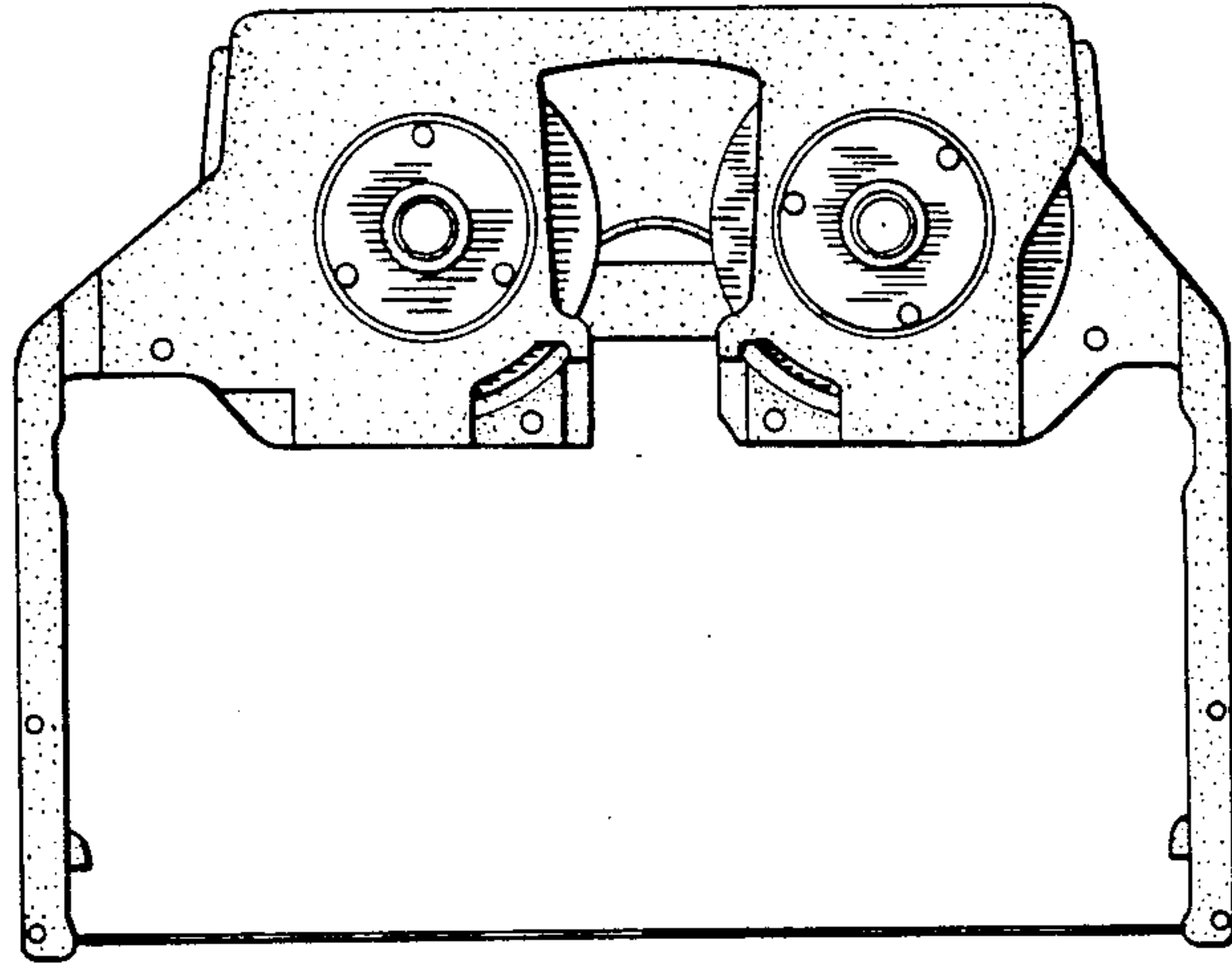

FIG. 4

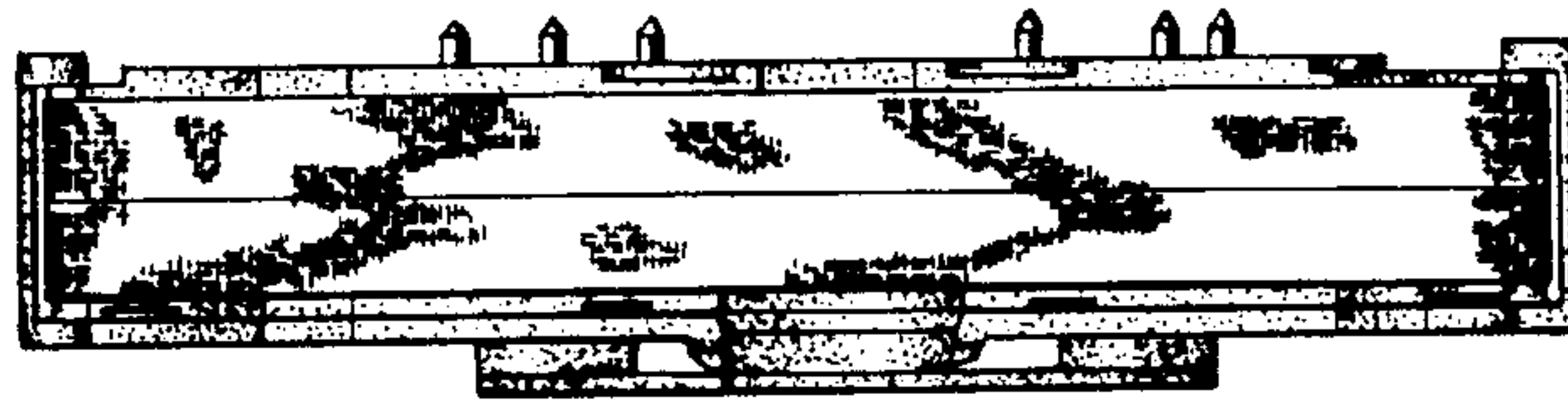

FIG. 5

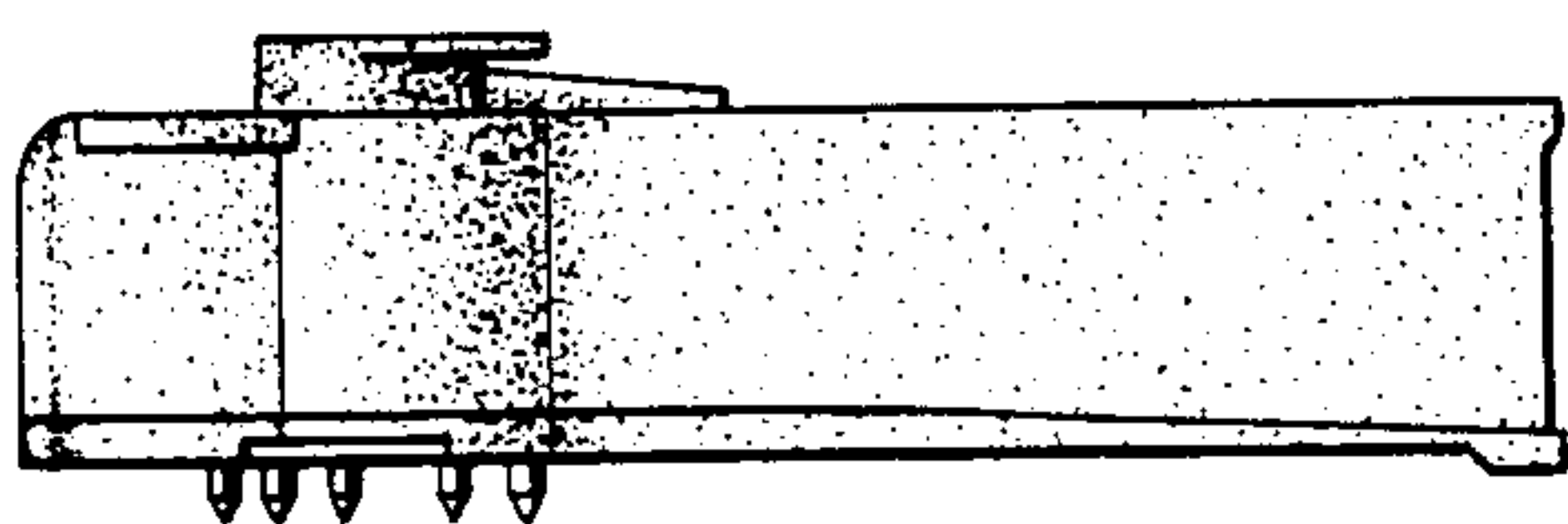

FIG. 6

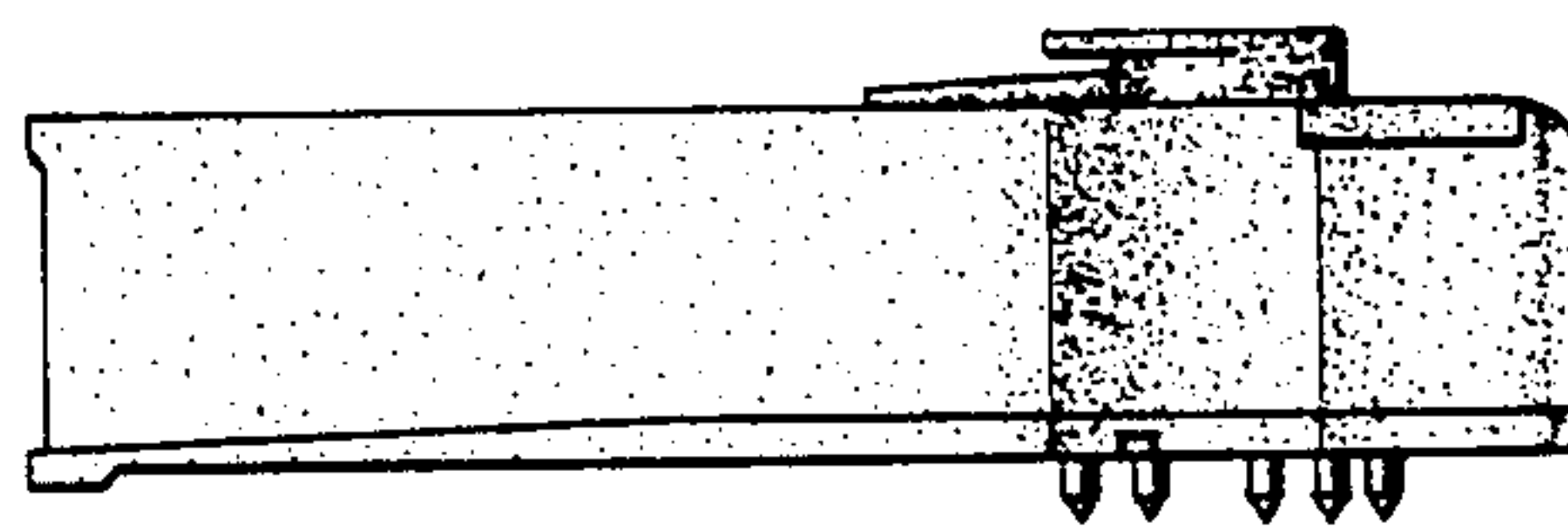

FIG. 7