

[54] **HOOP ROLLER**  
[76] **Inventor: Maurice O'Meara, R.R. 2, Charter Oak, Iowa 51439**  
[\*\*] **Term: 14 Years**  
[21] **Appl. No.: 901,742**  
[22] **Filed: May 1, 1978**  
[51] **Int. Cl. .... D21-01**  
[52] **U.S. Cl. .... D21/101**  
[58] **Field of Search ..... D21/101; 46/114, 220; 273/129 Q, 97 R**

3,037,321 6/1962 Thomason ..... 46/220  
3,715,834 2/1973 Gelis ..... 46/220  
3,758,984 9/1973 Spransy et al. .... 46/220

*Primary Examiner*—Charles A. Rademaker  
*Attorney, Agent, or Firm*—H. Robert Henderson

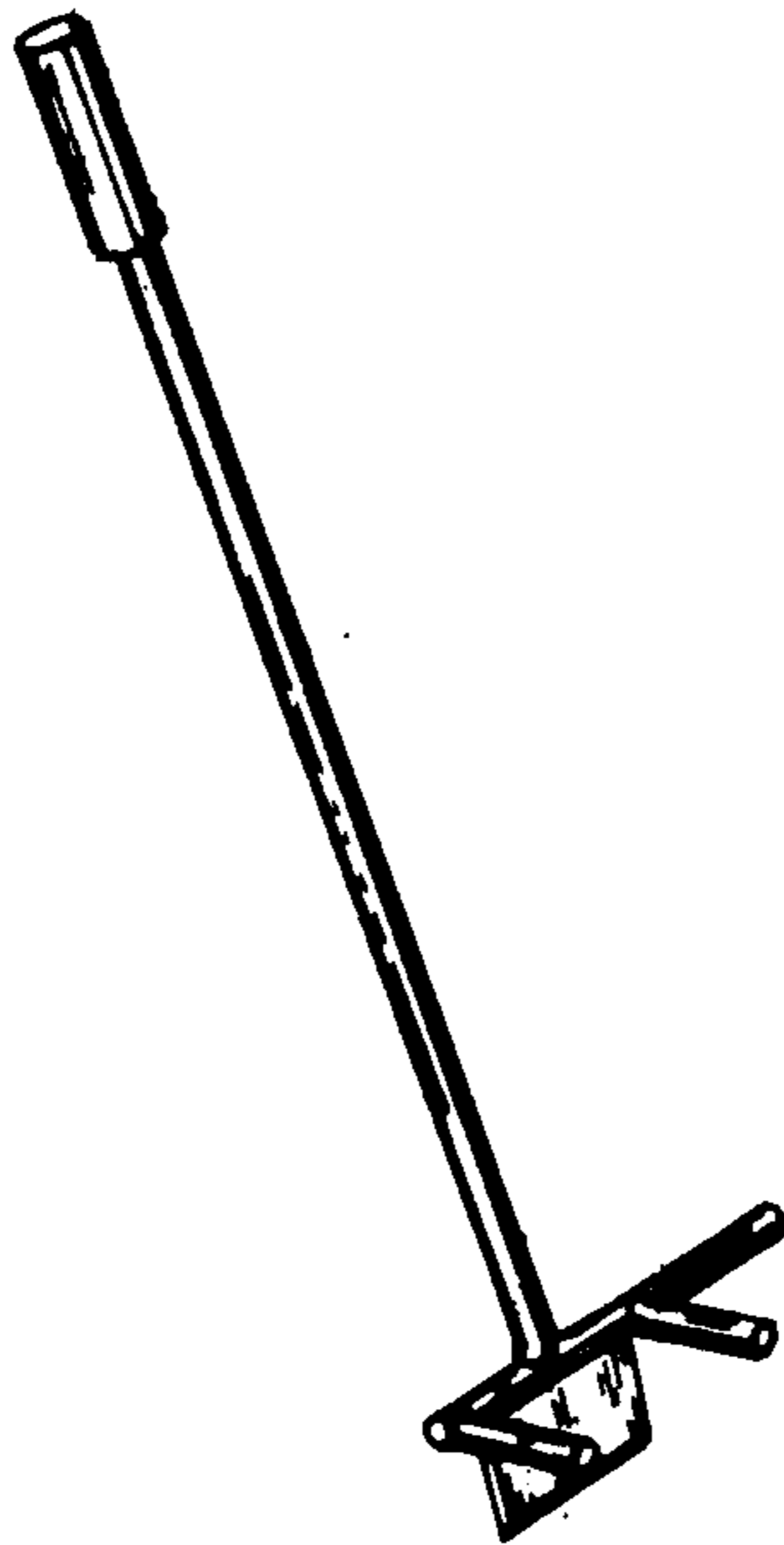
[57] **CLAIM**

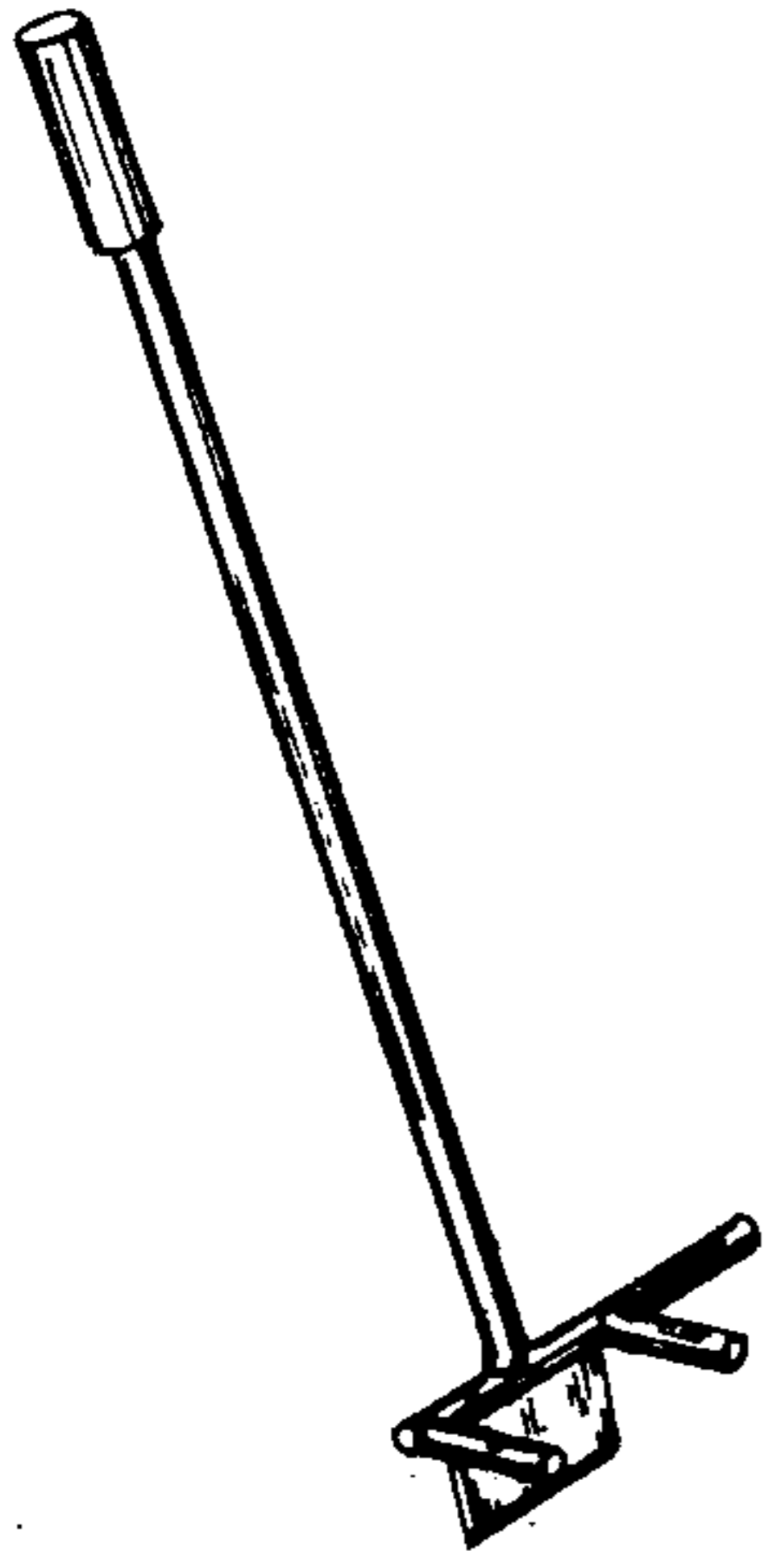
The ornamental design for hoop roller, or the like, substantially as shown and described.

**DESCRIPTION**

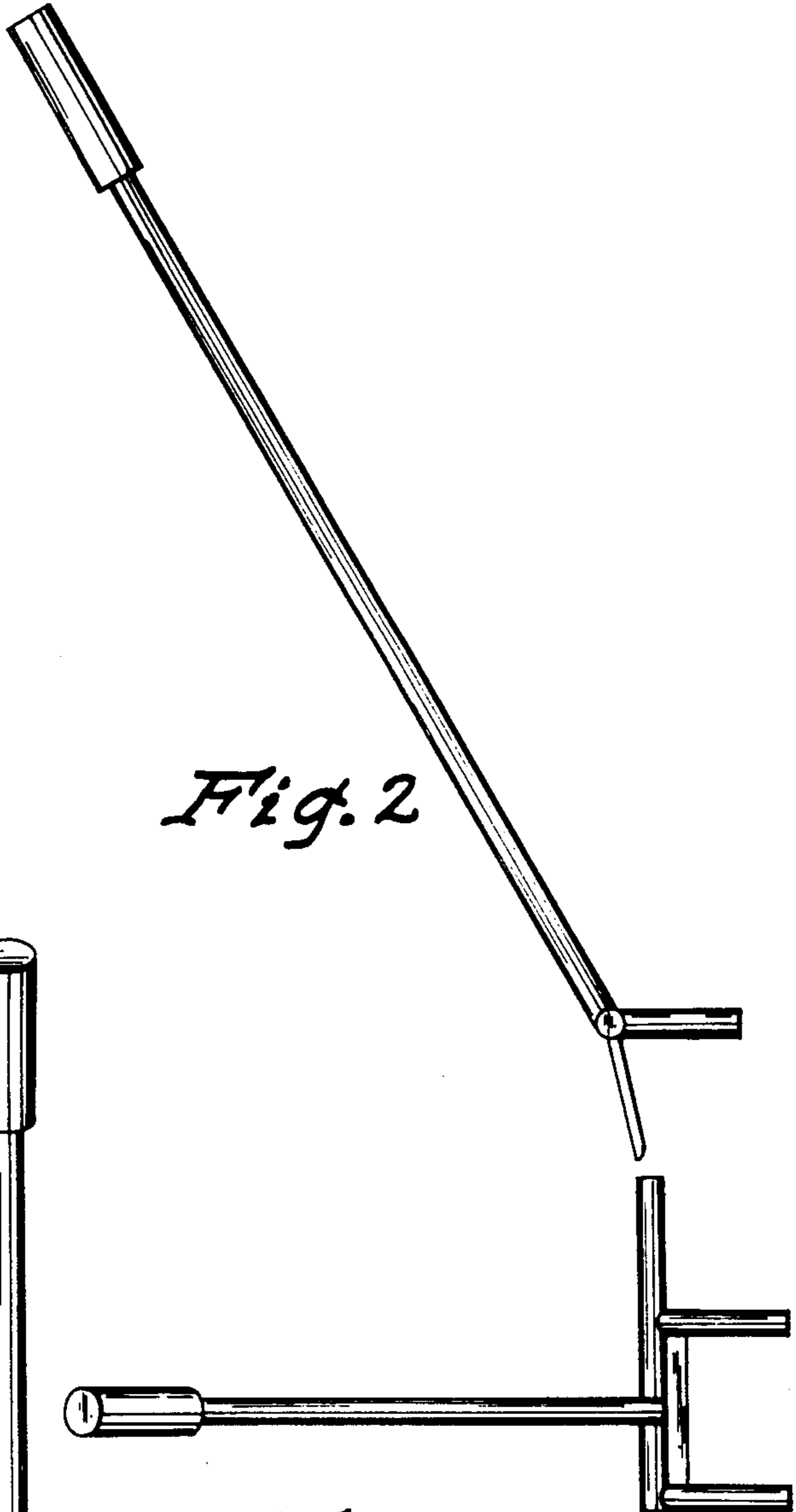
FIG. 1 is a perspective view of the hoop roller, or the like, showing my new design;  
FIG. 2 is a side elevational view thereof shown on an enlarged scale;  
FIG. 3 is a front elevational view thereof;  
FIG. 4 is a rear elevational view thereof;  
FIG. 5 is a top plan view thereof; and  
FIG. 6 is a bottom plan view thereof.

[56] **References Cited**  
**U.S. PATENT DOCUMENTS**  
D. 211,797 7/1968 Fisher ..... 46/220  
1,302,389 4/1919 Lemons ..... 46/114

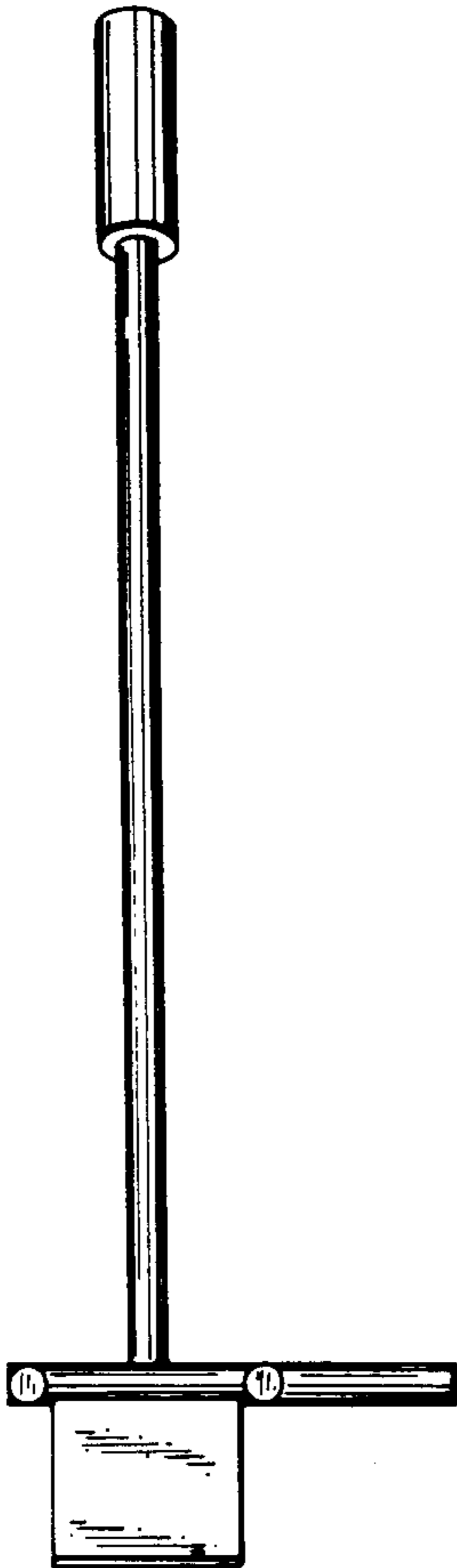




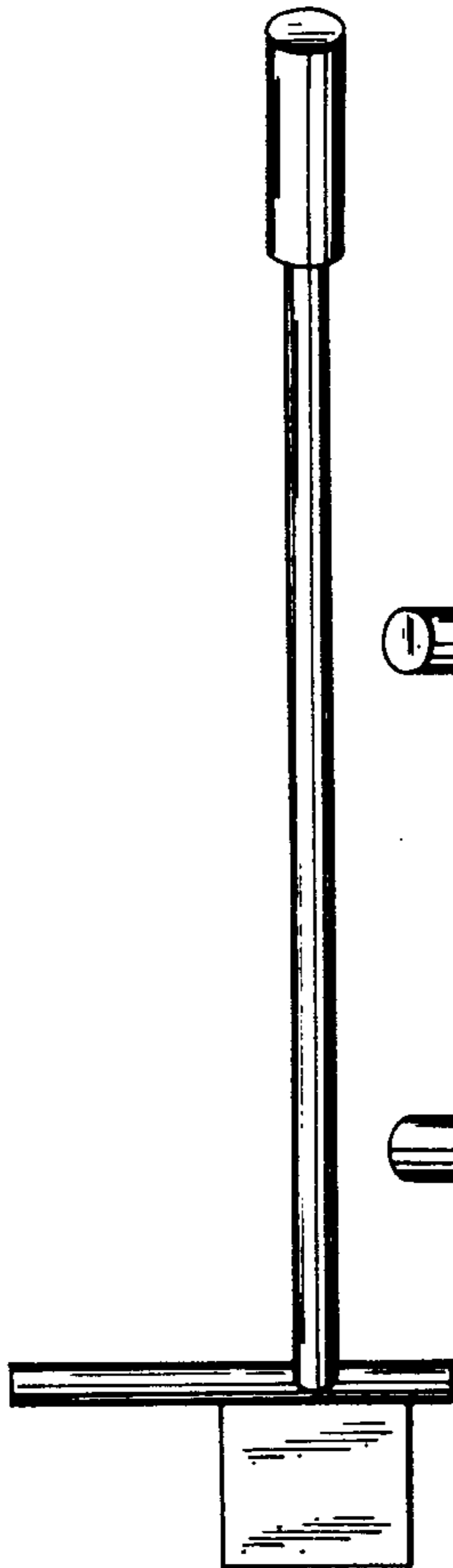
*Fig. 1*



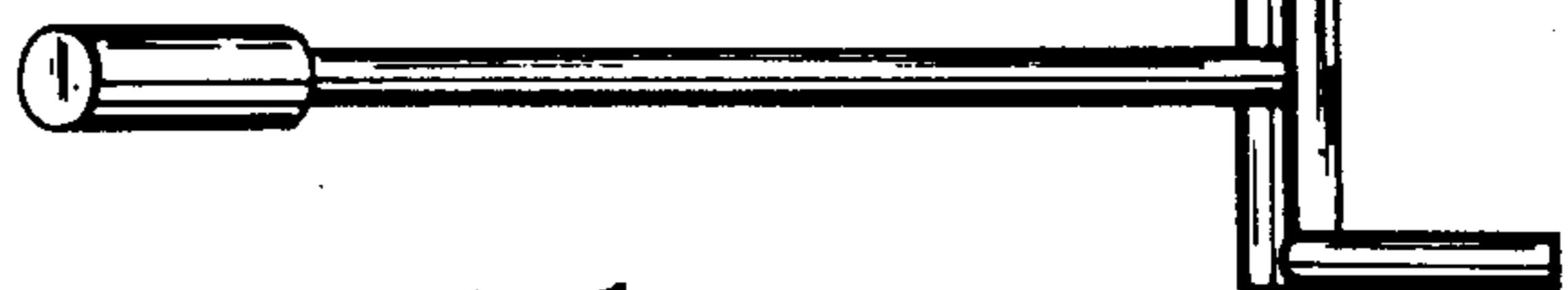
*Fig. 2*



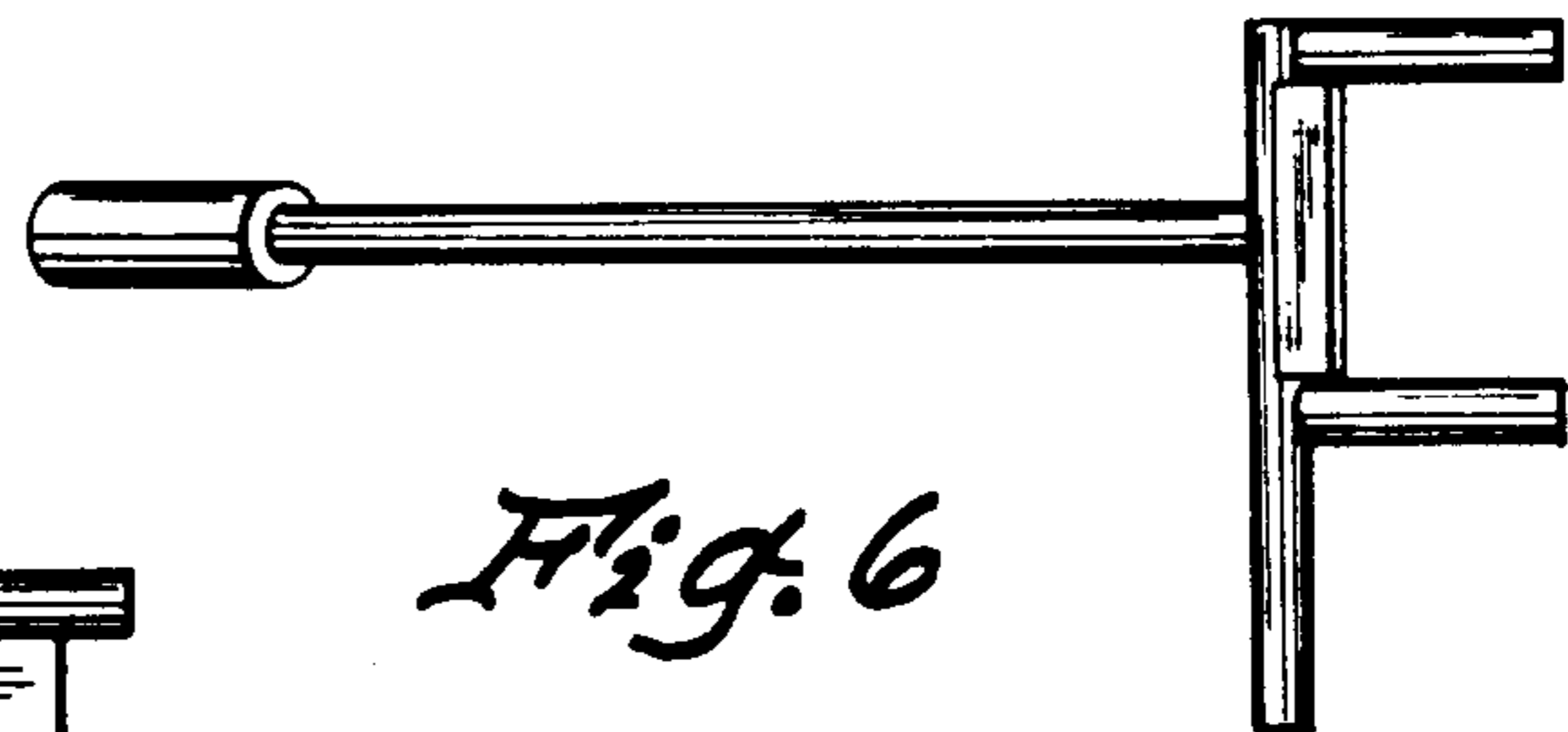
*Fig. 3*



*Fig. 4*



*Fig. 5*



*Fig. 6*