

[54] STACKABLE LABORATORY RACK OR THE LIKE

[75] Inventor: Robert S. Potts, Sherborn, Mass.

[73] Assignee: Corning Glass Works

[**] Term: 14 Years

[21] Appl. No.: 889,607

[22] Filed: Mar. 23, 1978

[51] Int. Cl. D24-02

[52] U.S. Cl. D24/32

[58] Field of Search D24/31, 32; 211/71, 211/74, 60 R

[56] References Cited

U.S. PATENT DOCUMENTS

D. 250,348	11/1978	Frangiosa et al.	D24/32
4,160,803	7/1979	Potts	206/509

Primary Examiner—Sam Rosen
Attorney, Agent, or Firm—Burton R. Turner

[57] CLAIM

The ornamental design for a stackable laboratory rack or the like, as shown and described.

DESCRIPTION

FIG. 1 is a top view of stackable laboratory rack or the like embodying my new design;

FIG. 2 is a front view thereof with the opposite side being identical but for the numbered indent;

FIG. 3 is a side view thereof with the opposite side being identical;

FIG. 4 is a side sectional view taken along line 4—4 of FIG. 1.

FIG. 5 is a side sectional view taken along line 5—5 of FIG. 1.

FIG. 6 is a fragmental bottom view of the leg shown as 6—6 of FIG. 2 with the opposite leg being identical.

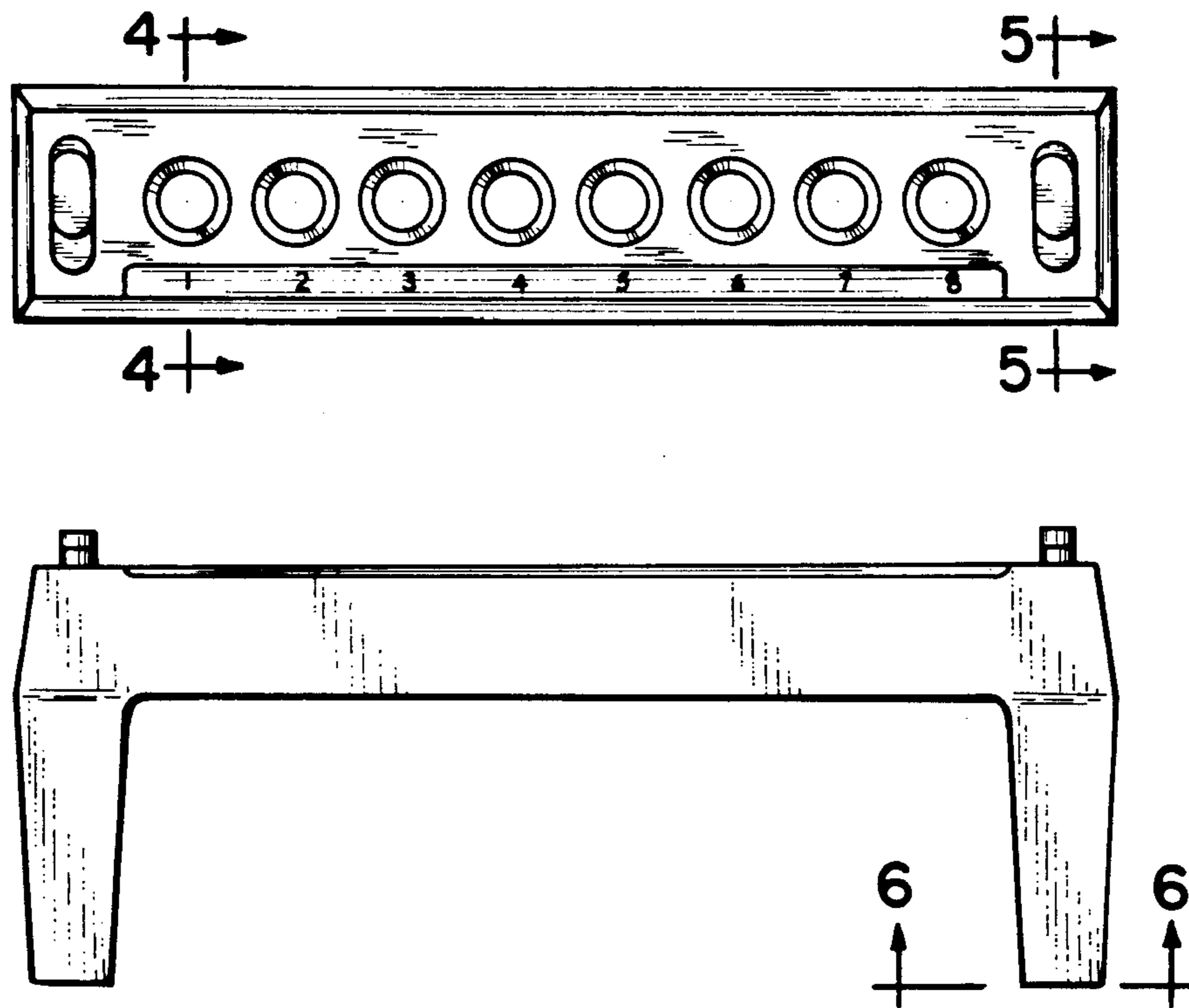

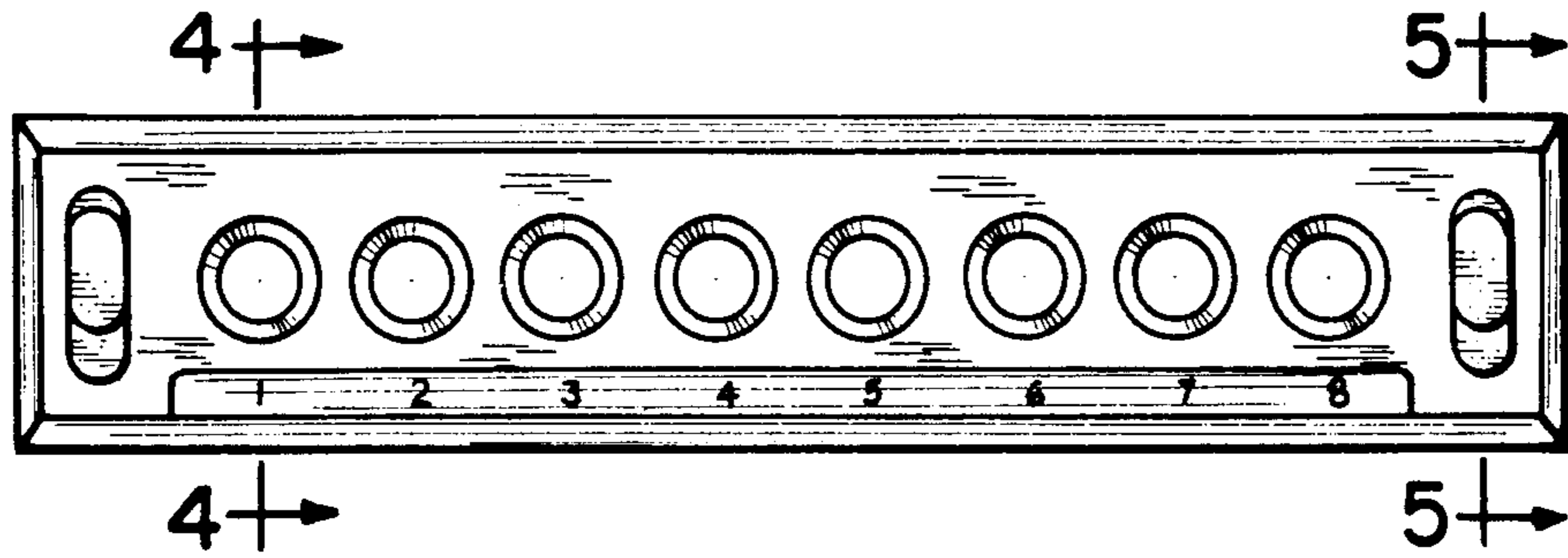

Fig. 1

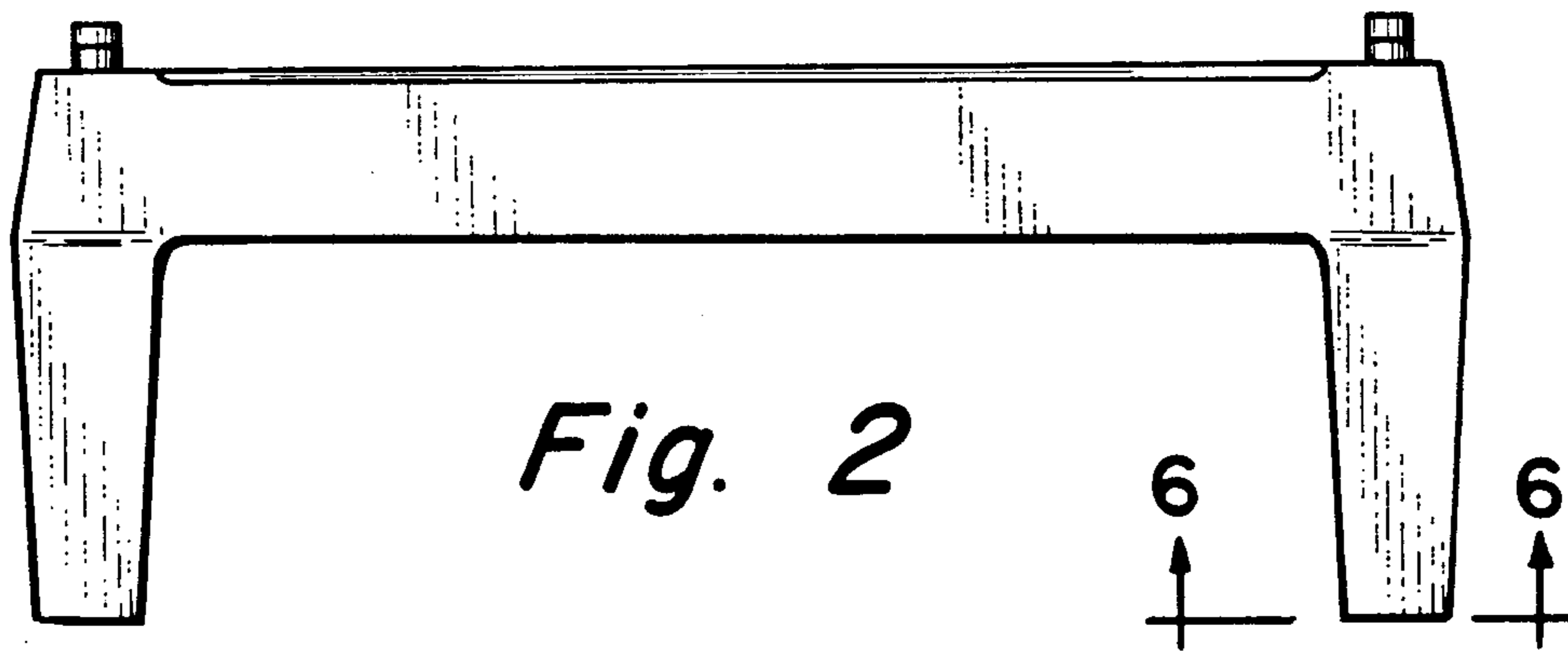

Fig. 2

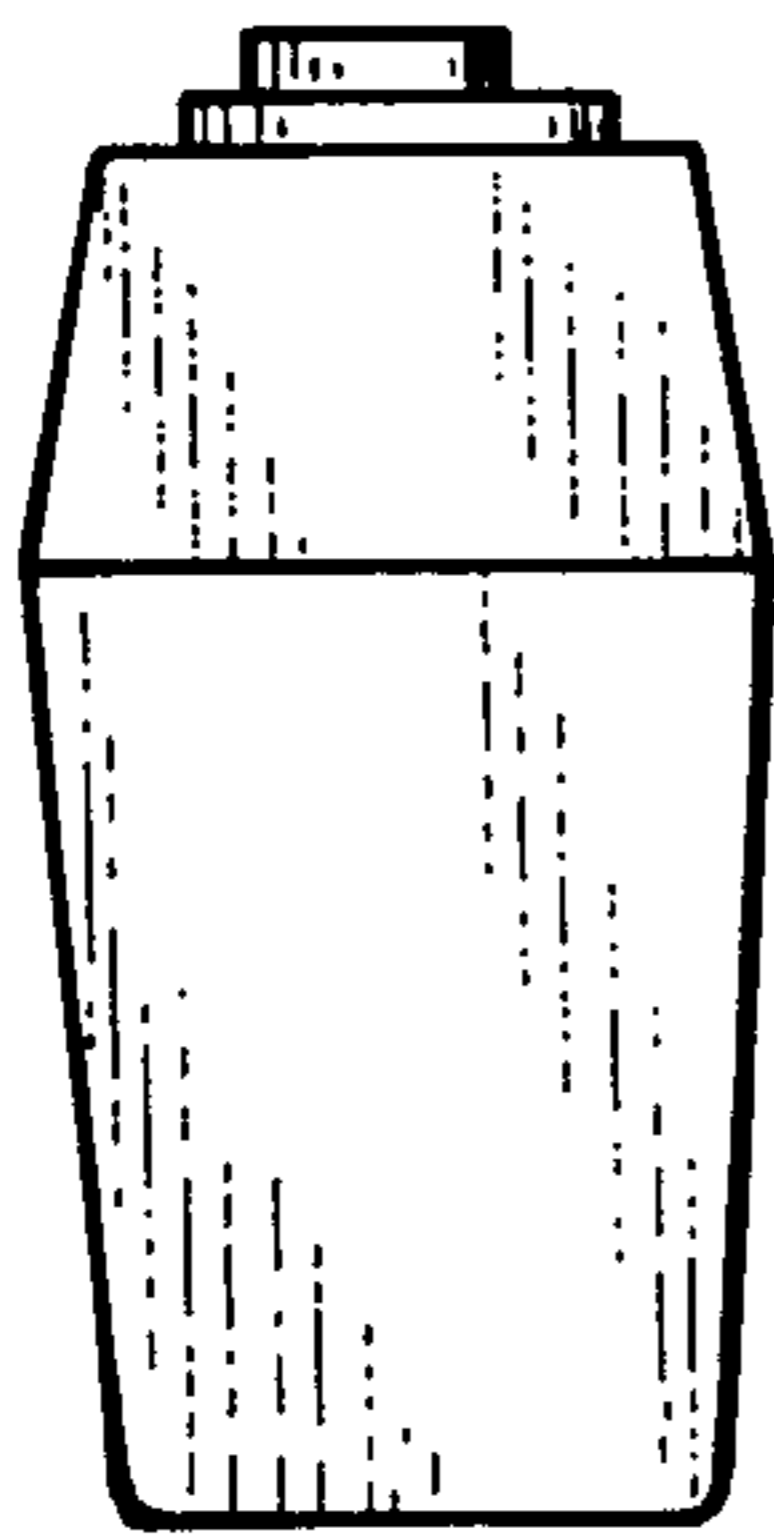

Fig. 3

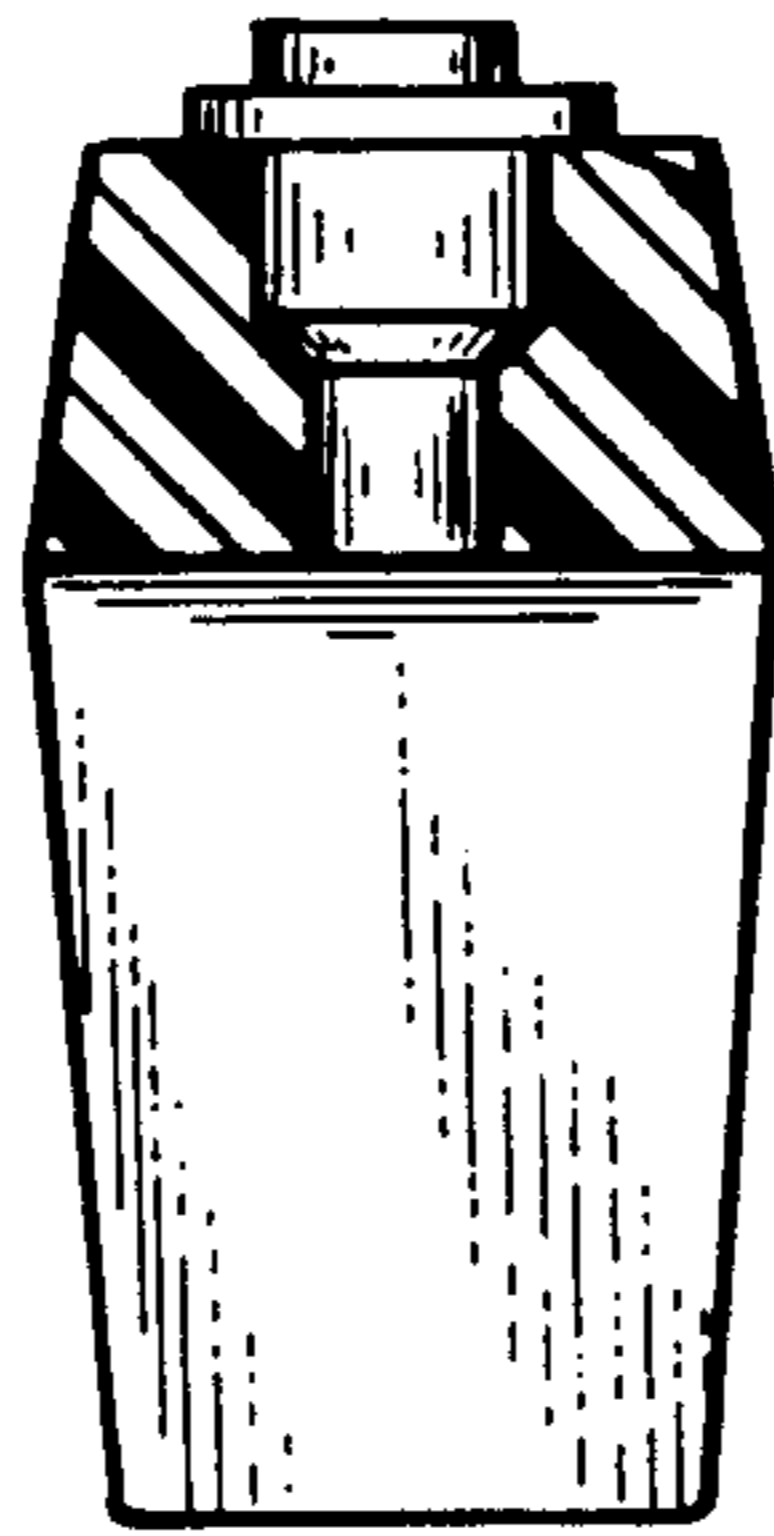

Fig. 4

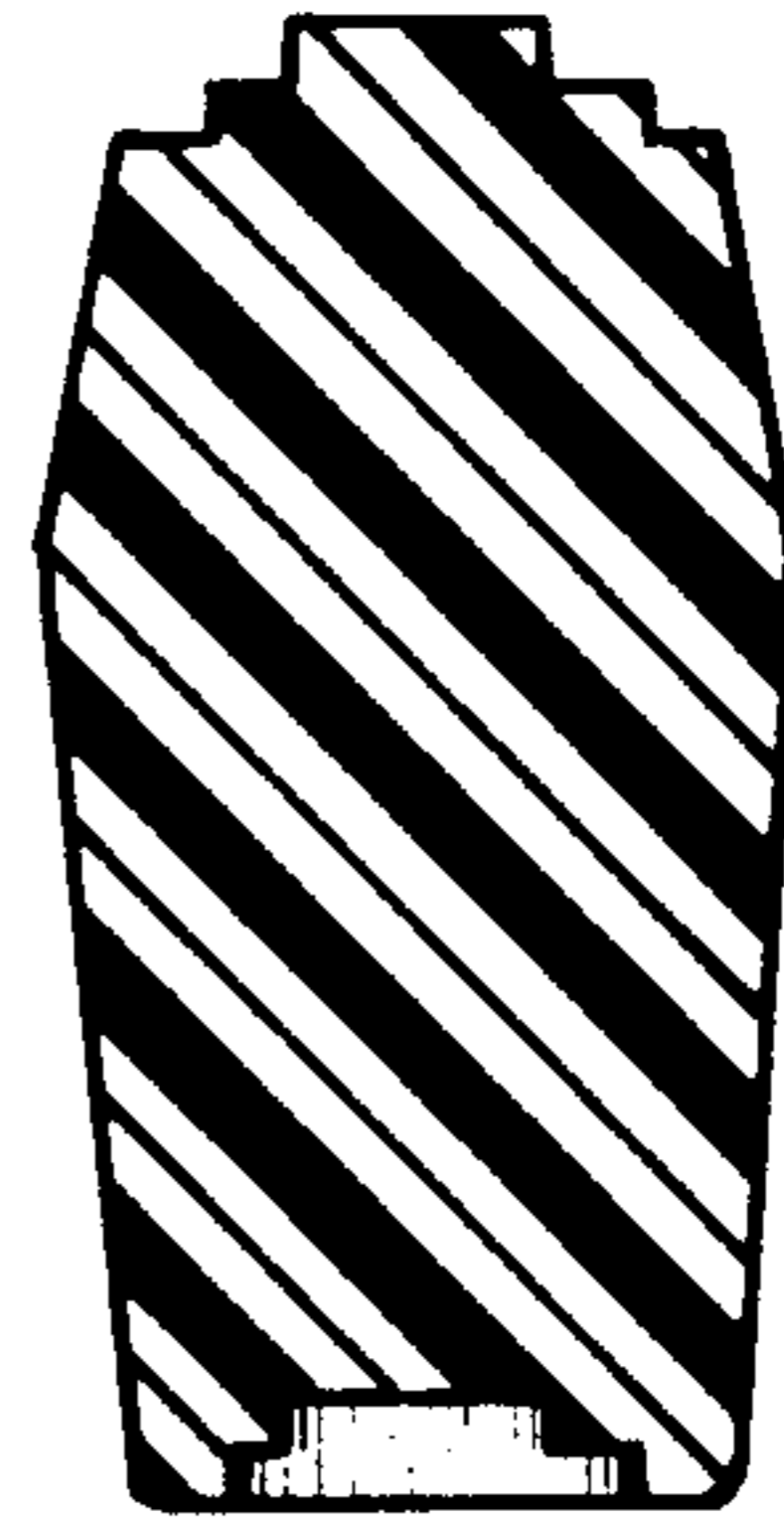

Fig. 5

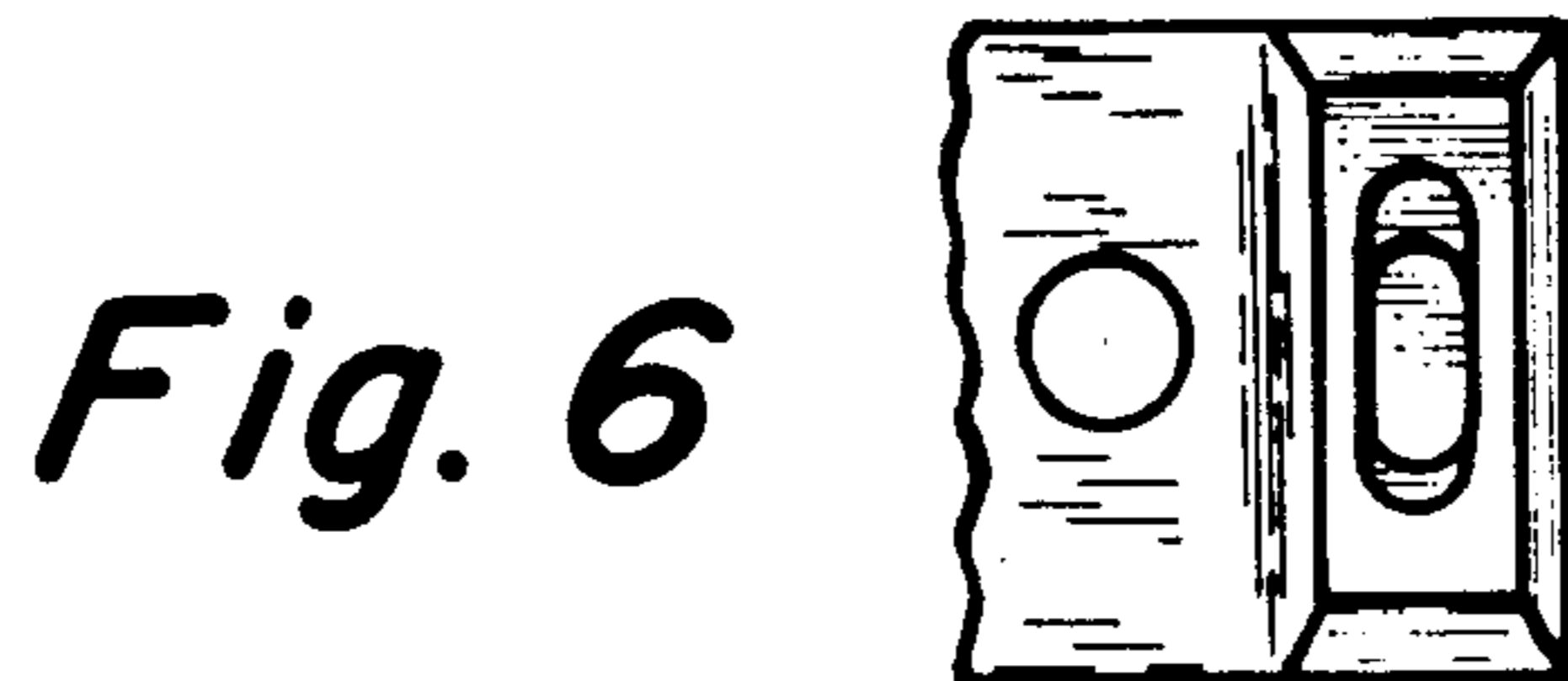

Fig. 6