

[54] SUGAR BOWL OR THE LIKE

[75] Inventor: Rino Conti, Stoughton, Mass.

[73] Assignee: Dart Industries Inc., Los Angeles, Calif.

[**] Term: 14 Years

[21] Appl. No.: 39,535

[22] Filed: May 16, 1979

[51] Int. Cl. D07-06

[52] U.S. Cl. D7/64; D7/10; D7/58

[58] Field of Search D7/59-67, D7/52, 58, 10, 3, 9

[56] References Cited

U.S. PATENT DOCUMENTS

D. 155,304	9/1949	McKay	D7/10
D. 237,770	11/1975	Daenen	D7/59
2,792,696	5/1957	Stayart	D7/10 X
3,760,972	9/1973	McKirnan	D7/59 X

Primary Examiner—Winifred E. Herrmann
Attorney, Agent, or Firm—Leigh B. Taylor

[57] CLAIM

The ornamental design for a sugar bowl or the like, substantially as shown.

DESCRIPTION

FIG. 1 is a top perspective view of a sugar bowl or the like showing my new design;
FIG. 2 is a front elevational view thereof;
FIG. 3 is a side elevational view thereof;
FIG. 4 is a top plan view thereof;
FIG. 5 is a bottom plan view thereof; and,
FIG. 6 is a rear elevational view thereof partially cross-sectioned along line 6-6 of FIG. 4.

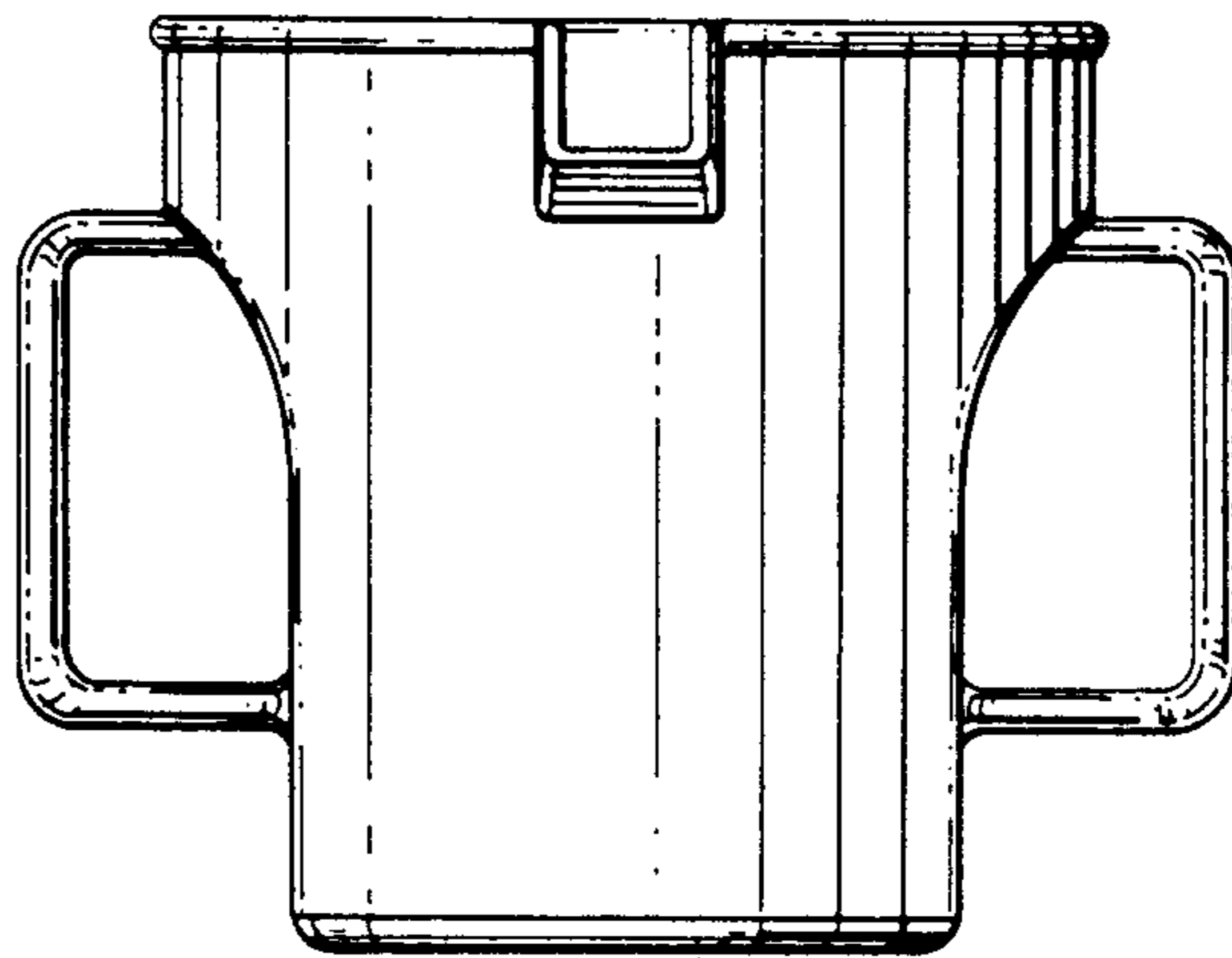
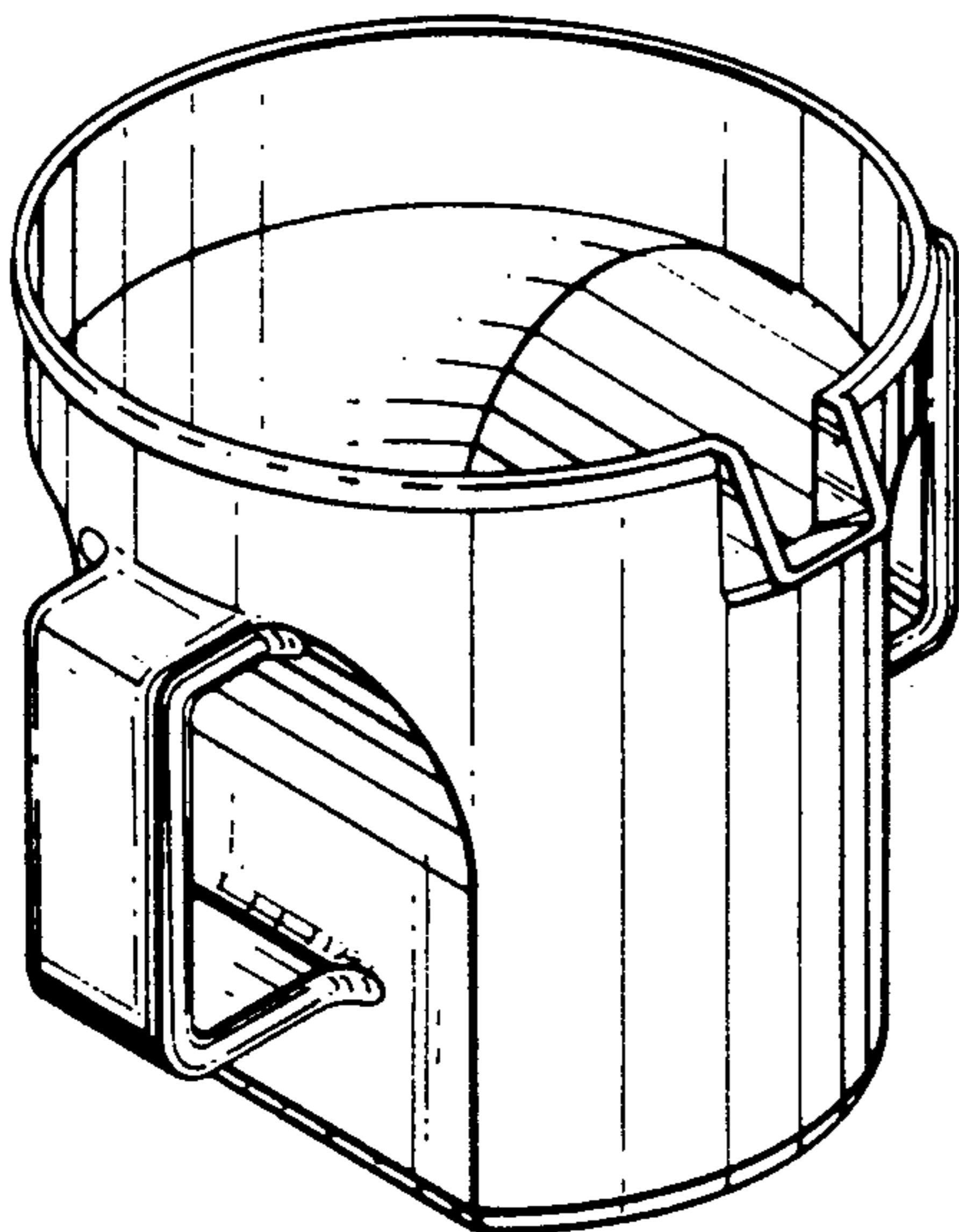

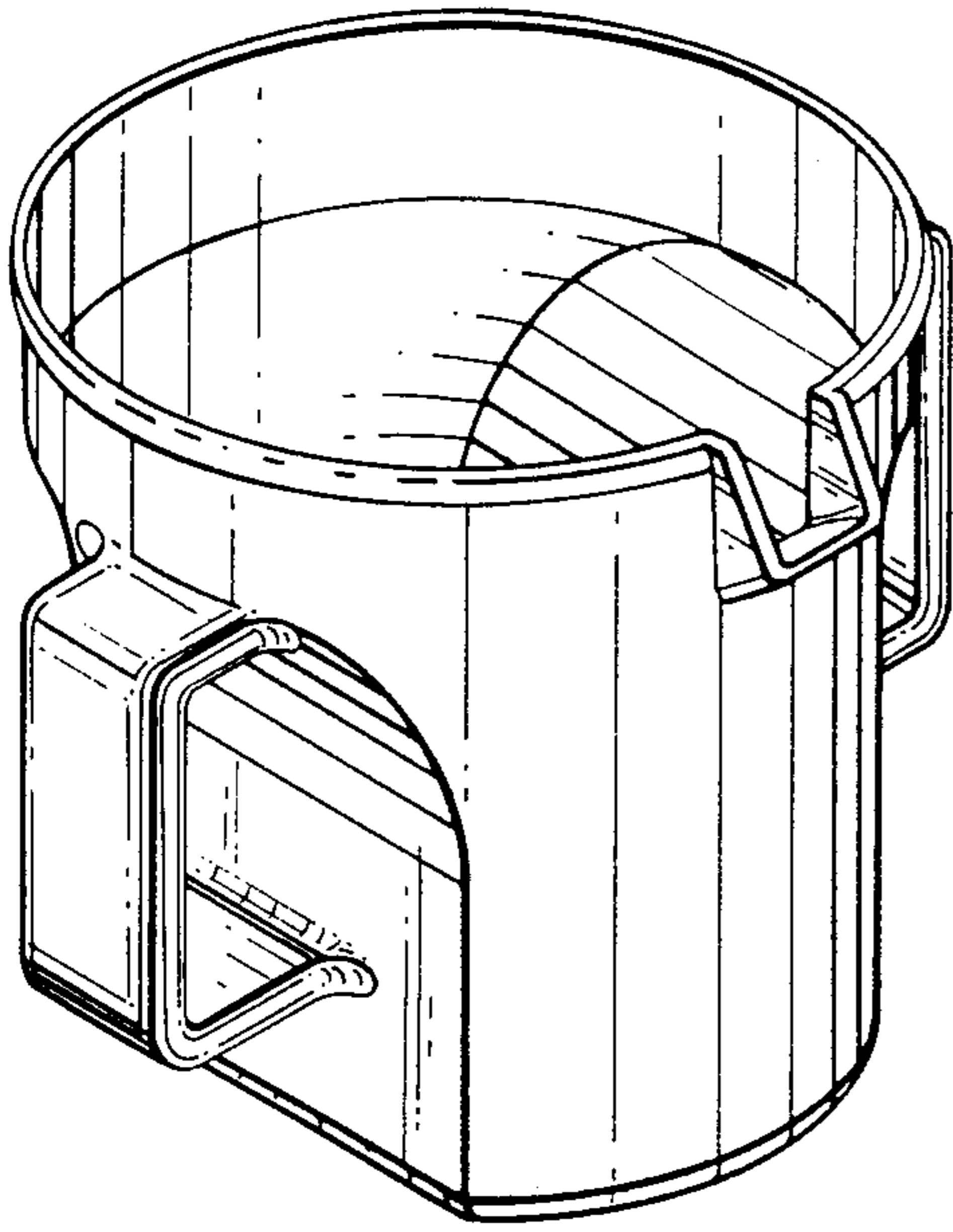

FIG. 1

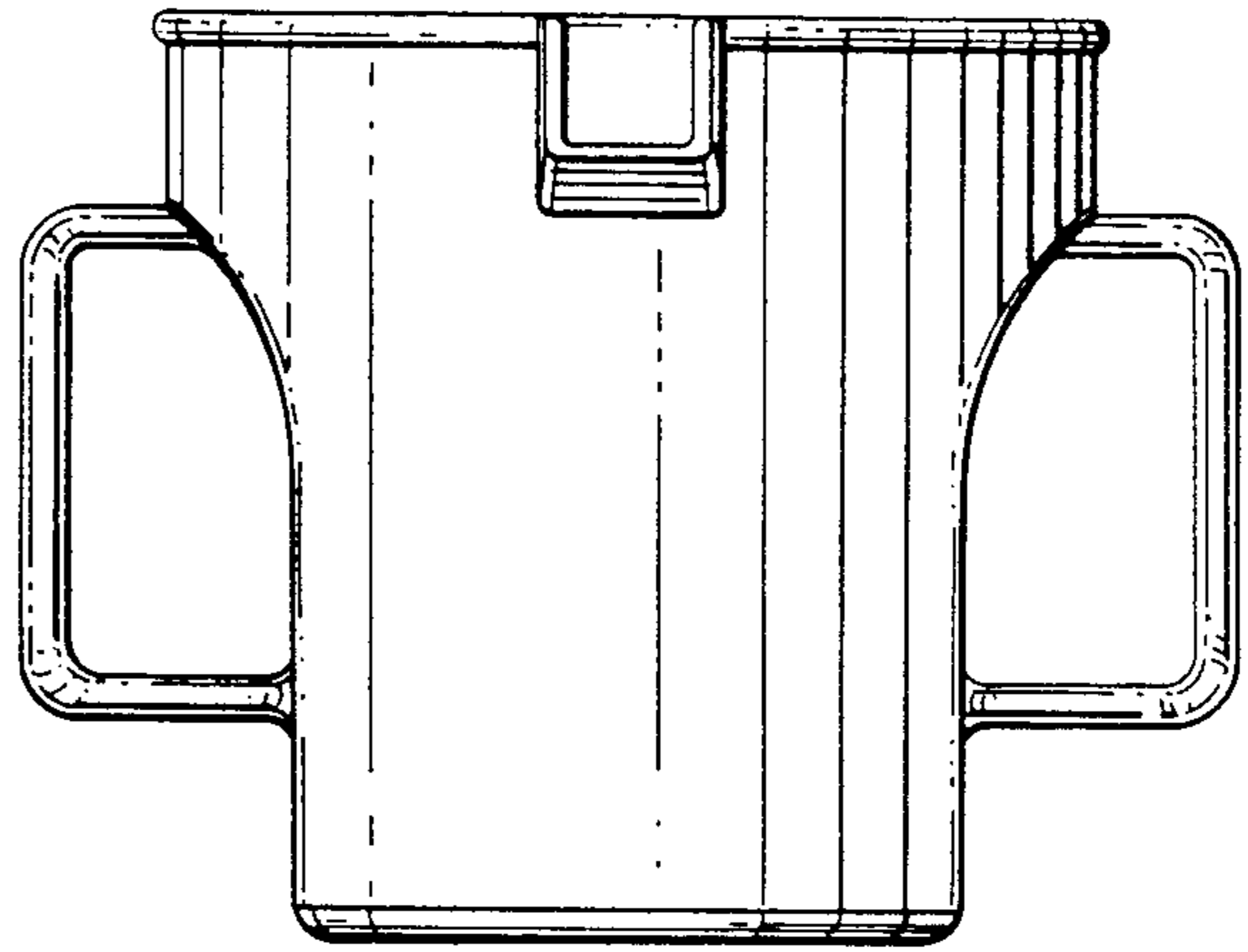

FIG. 2

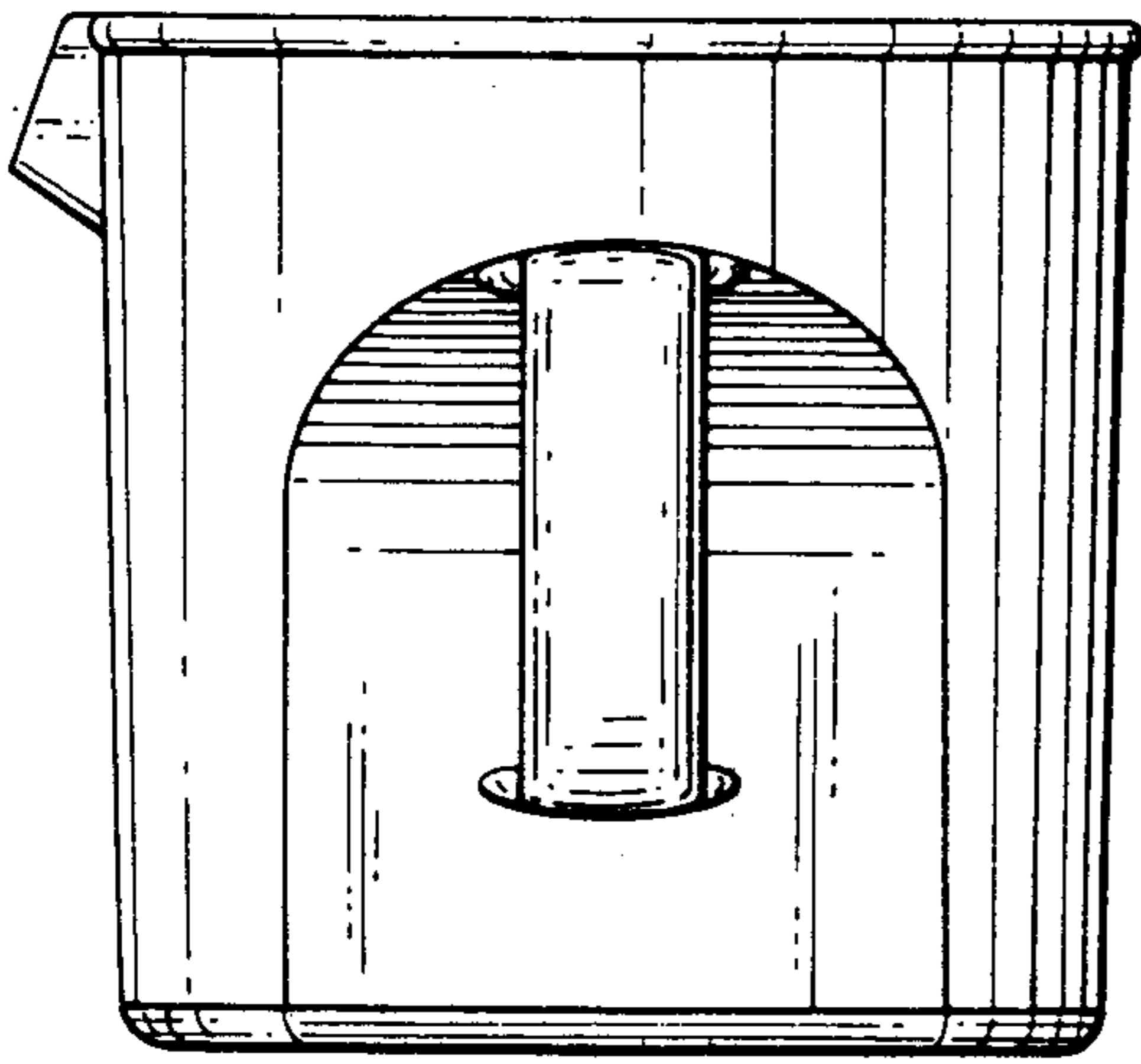

FIG. 3

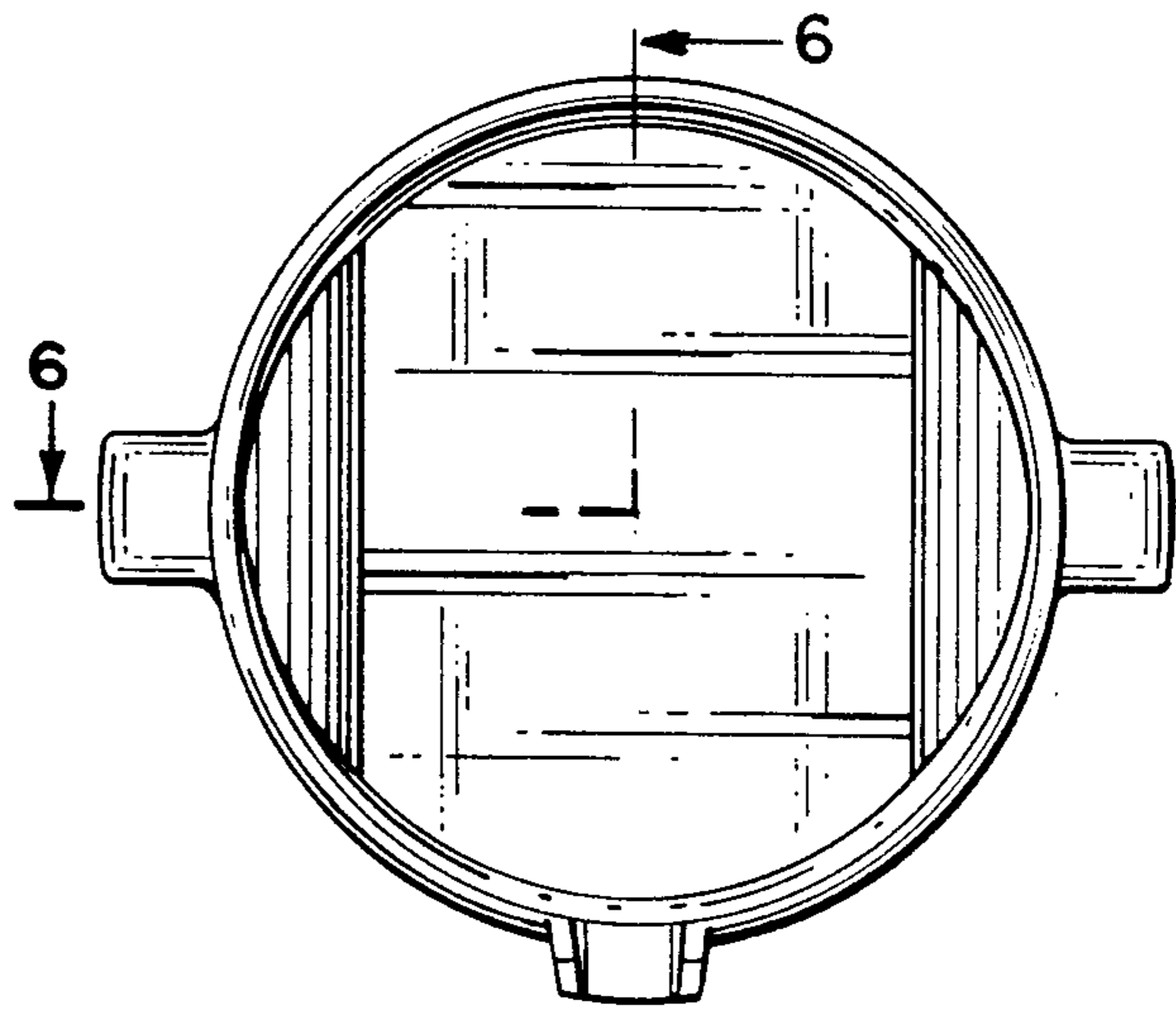

FIG. 4

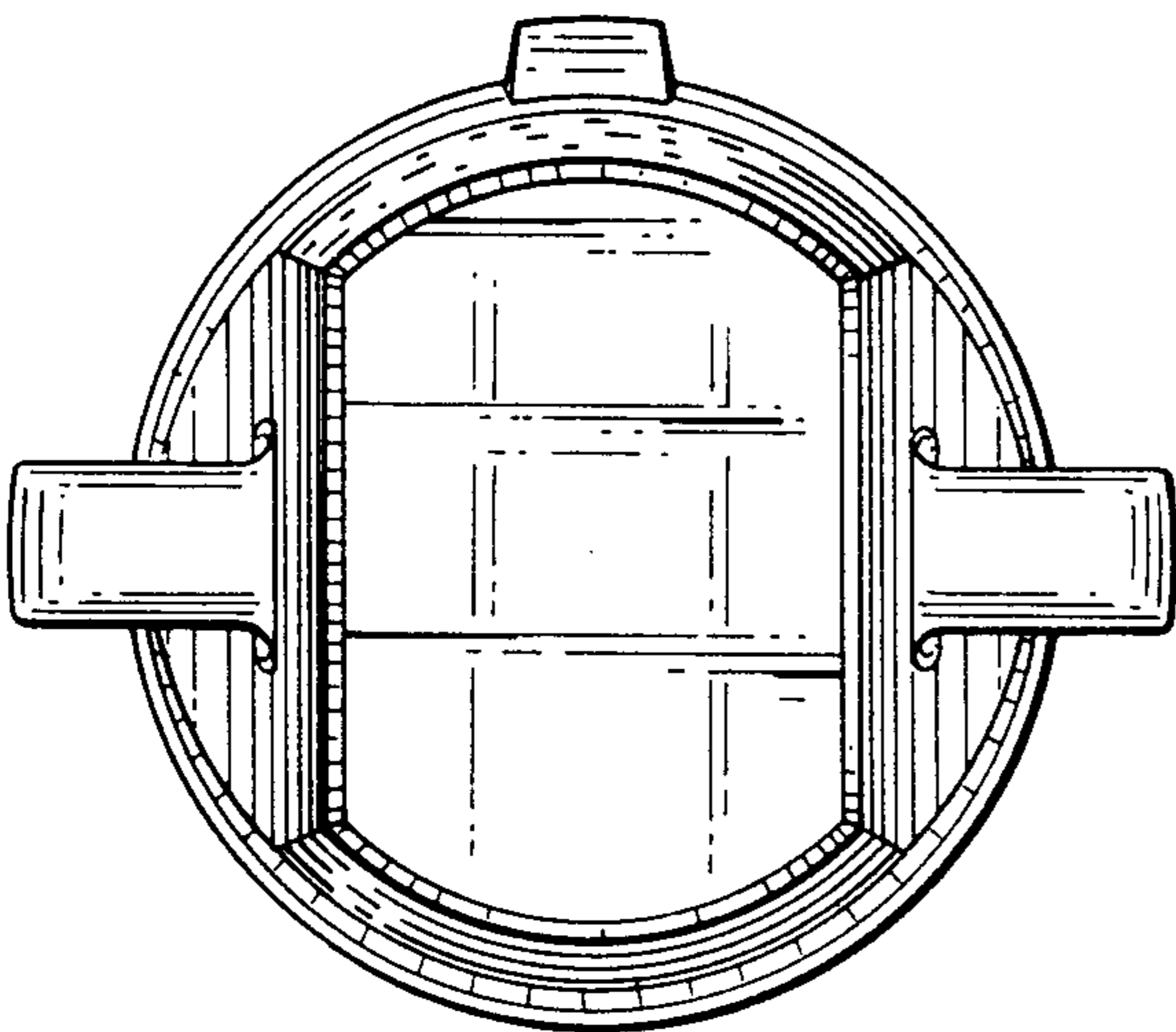

FIG. 5

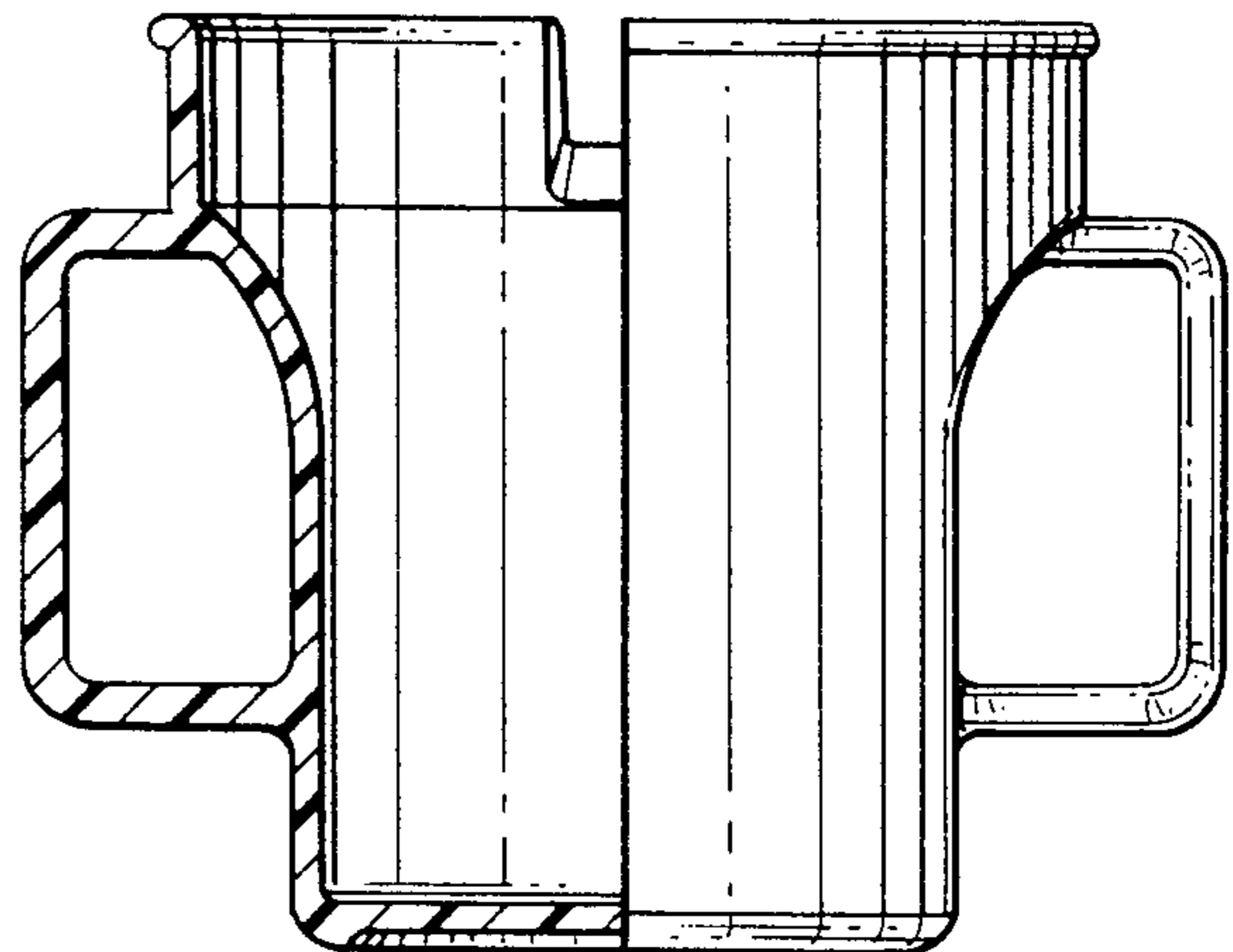

FIG. 6