

[54] GOLF ACCESSORY HOLDER

[76] Inventor: Thomas C. Bonaventura, 10762 Garfield Ave., Culver City, Calif. 90230

[**] Term: 14 Years

[21] Appl. No.: 967,617

[22] Filed: Dec. 8, 1978

[51] Int. Cl. D02-99

[52] U.S. Cl. D2/400; D21/234

[58] Field of Search D2/400; 224/45 L, 918, 224/919; D21/204, 206, 208, 234

[56] References Cited

U.S. PATENT DOCUMENTS

D. 190,919	7/1961	Kolarik	D21/206
D. 242,402	11/1976	Bratene et al.	D2/400
2,768,775	10/1956	Houser	D21/204

OTHER PUBLICATIONS

Better Homes and Gardens, Jun. 1951, p. 264, "Special Leather Holster", 3rd col. from left, second from top.

Primary Examiner—Joel Stearman
Assistant Examiner—Carmen H. Vales
Attorney, Agent, or Firm—Ralph B. Pastoriza

[57] CLAIM

The ornamental design for a golf accessory holder, substantially as shown.

DESCRIPTION

FIG. 1 is a perspective view of a golf accessory holder showing my new design;
FIG. 2 is a side elevational view thereof;
FIG. 3 is a front elevational view thereof;
FIG. 4 is a rear elevational view thereof;
FIG. 5 is a top plan view thereof; and,
FIG. 6 is a bottom plan view thereof.

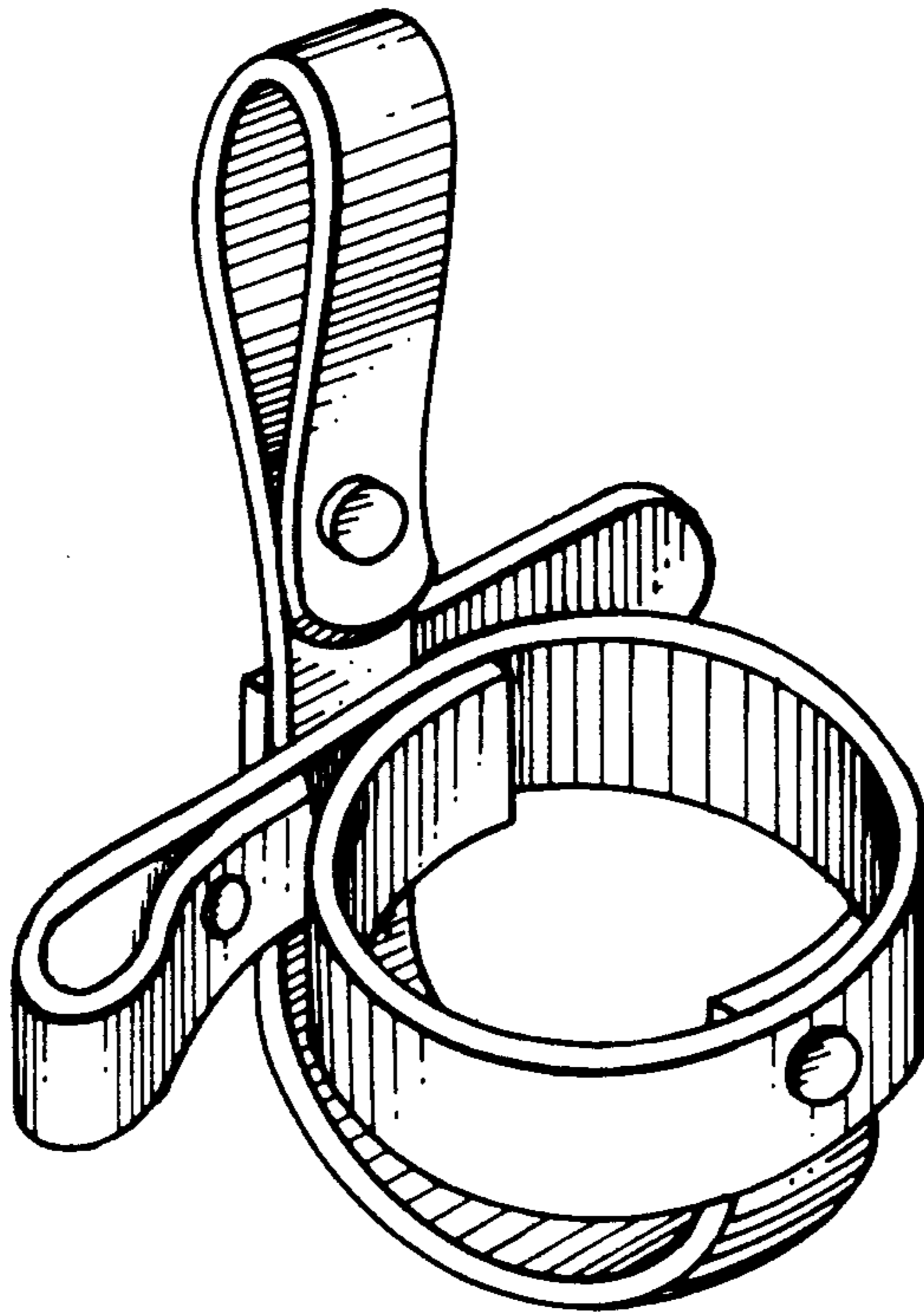

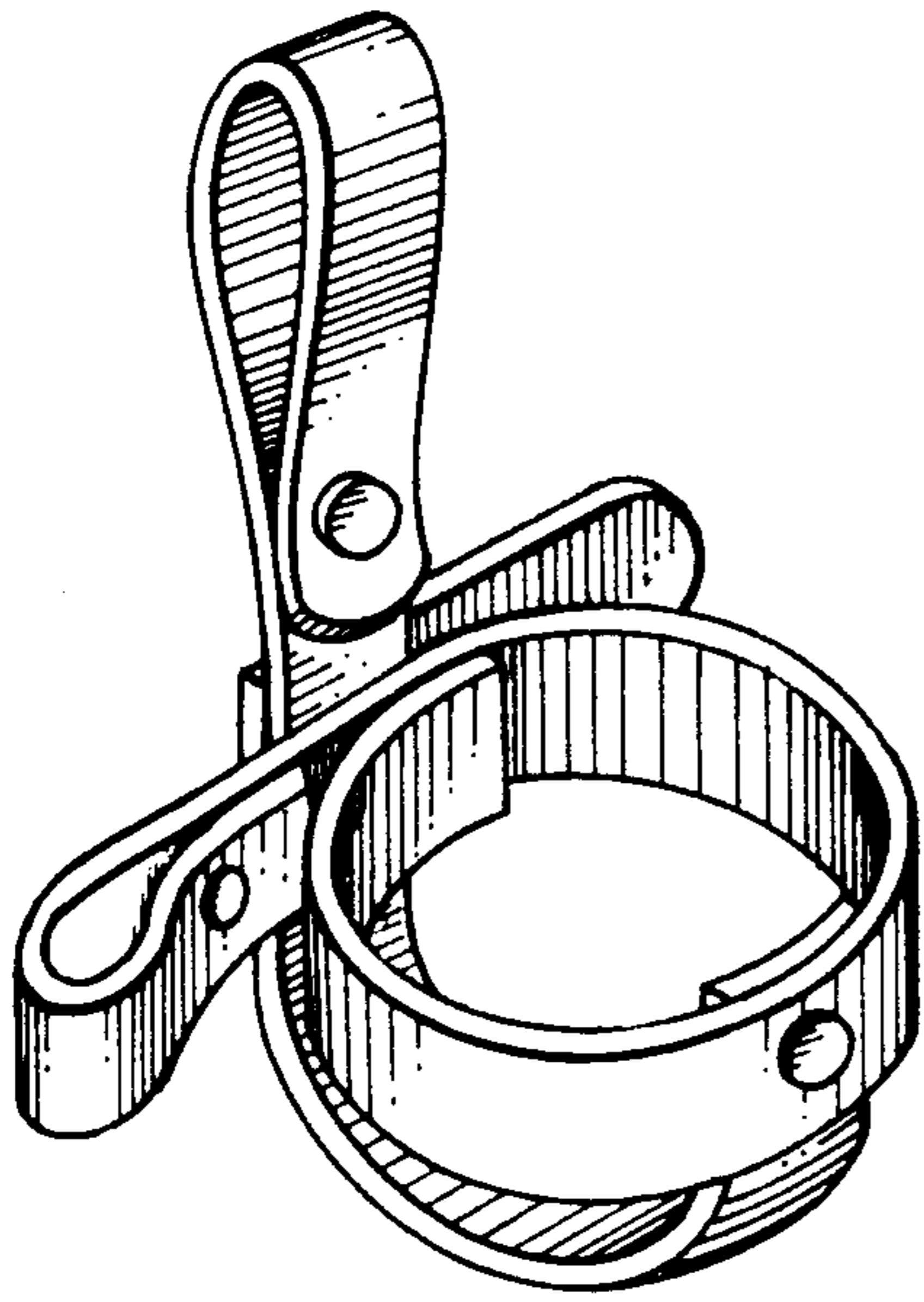

FIG. 1

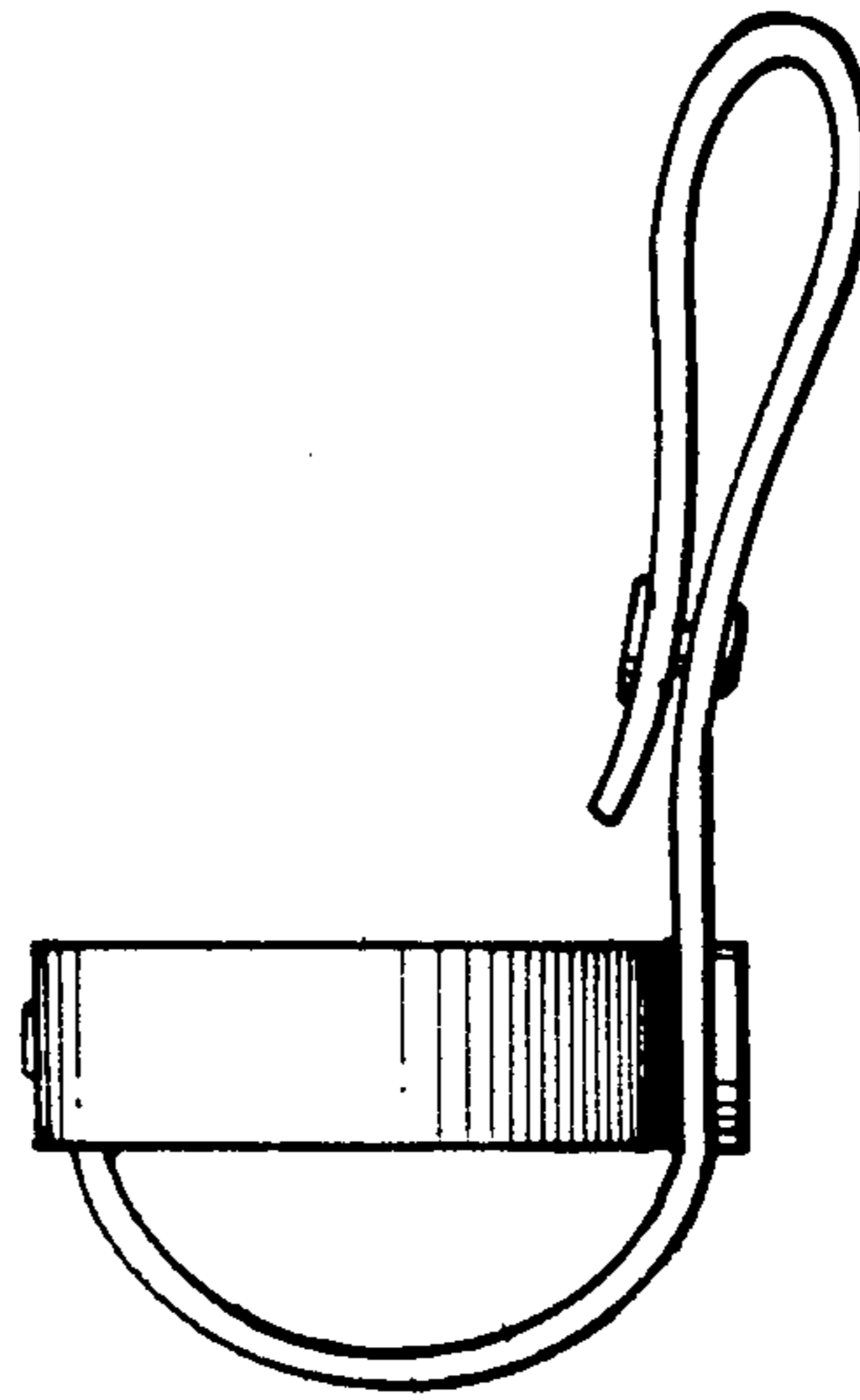

FIG. 2

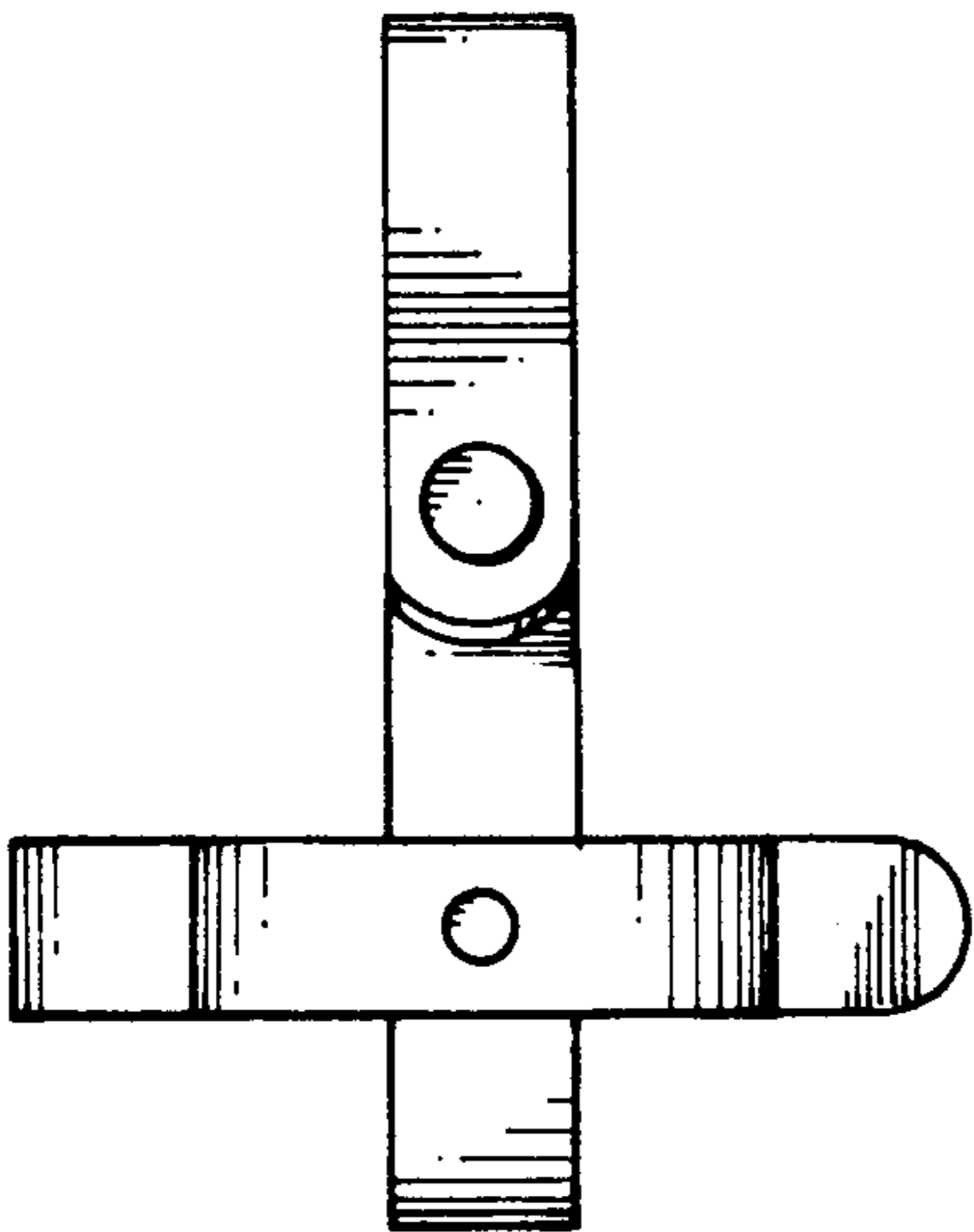

FIG. 3

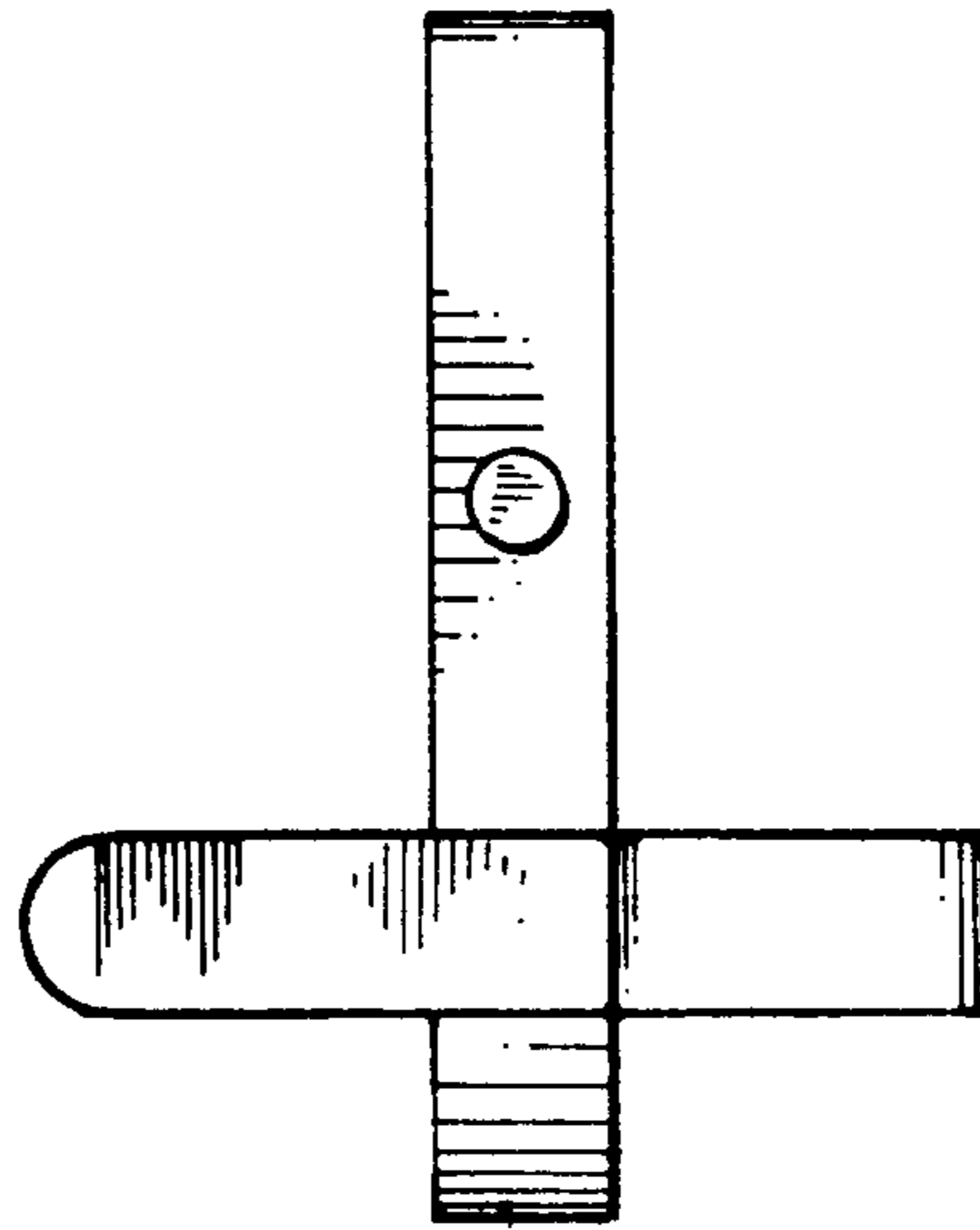

FIG. 4

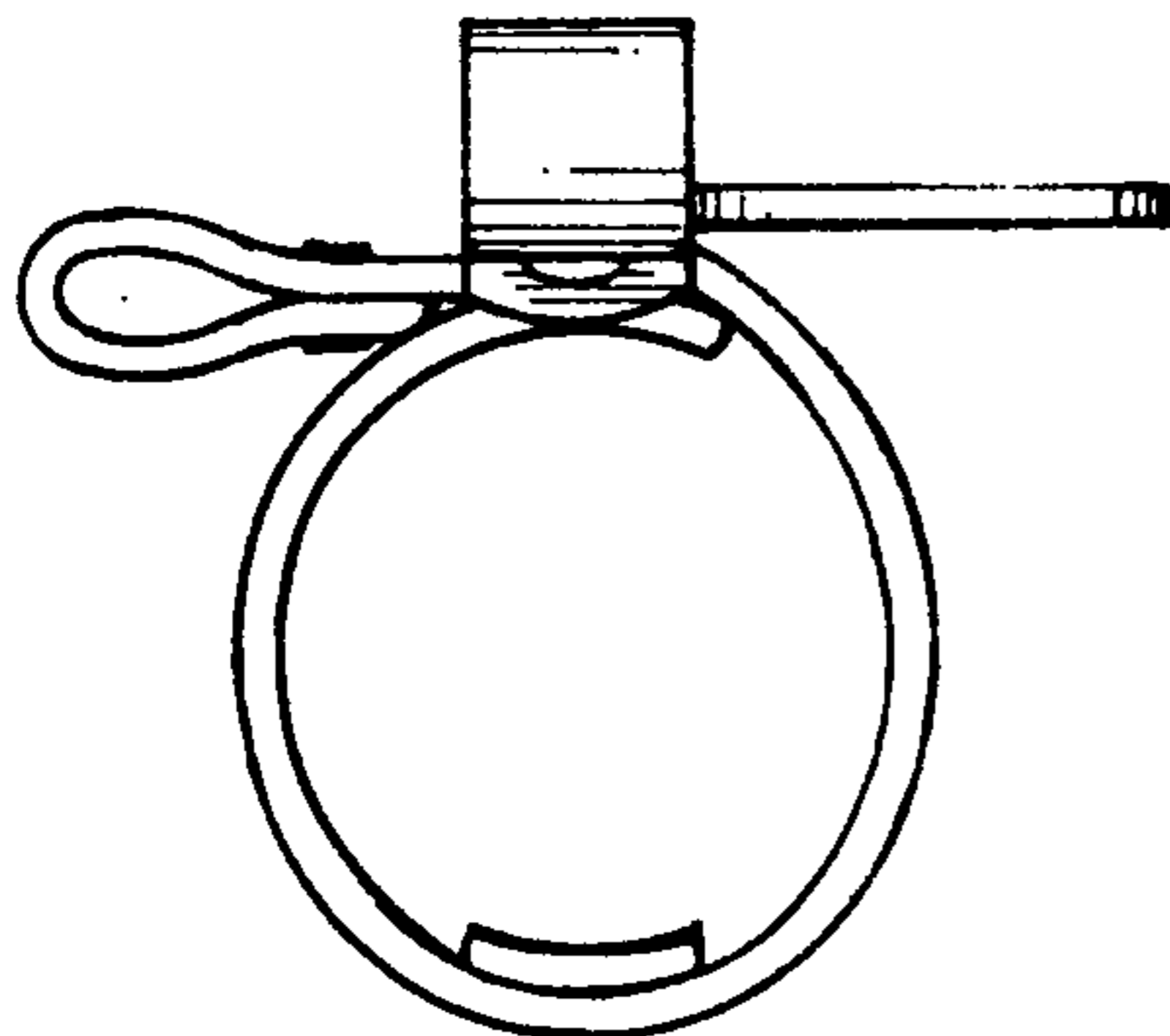

FIG. 5

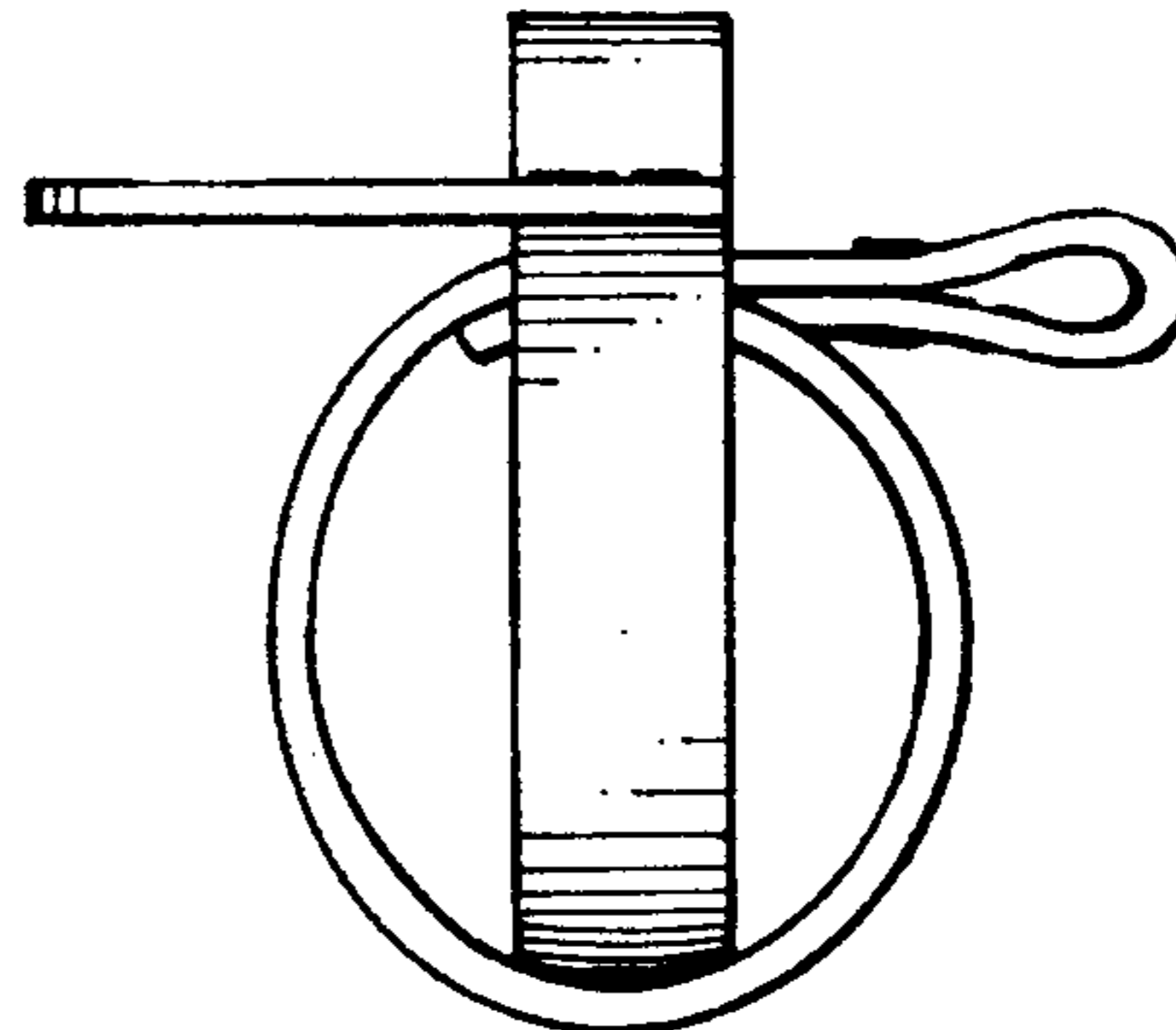

FIG. 6