

[54] MODEL AIRCRAFT SKI

[76] Inventors: **David K. Litt**, 11824 Chicago Plz., #3, Omaha, Nebr. 68124; **Donald L. Kaar**, 12230 N St., Omaha, Nebr. 68137

[\*\*] Term: **14 Years**

[21] Appl. No.: **945,352**

[22] Filed: **Sep. 25, 1978**

[51] Int. Cl. .... **D21-01**

[52] U.S. Cl. .... **D21/229; D21/91; D21/87**

[58] Field of Search ..... **D21/229, 228, 230, 231, D21/91, 87, 82; 46/76 R; 280/601, 609**

[56] **References Cited**  
**PUBLICATIONS**

American Modeler, Feb. 1967, p. 51, grey plastic skis at right center.

*Primary Examiner*—Donald B. Moyer  
*Attorney, Agent, or Firm*—Louis J. Strom

[57] **CLAIM**

The ornamental design for model aircraft ski, or the like, substantially as shown and described.

**DESCRIPTION**

FIG. 1 is a top perspective view of the model aircraft ski, or the like, showing our new design;  
FIG. 2 is a bottom plan view thereof;  
FIG. 3 is a top plan view thereof;  
FIG. 4 is a back elevational view thereof;  
FIG. 5 is a front elevational view thereof; and  
FIG. 6 is a side elevational view wherein the opposite side is a mirror image thereof.

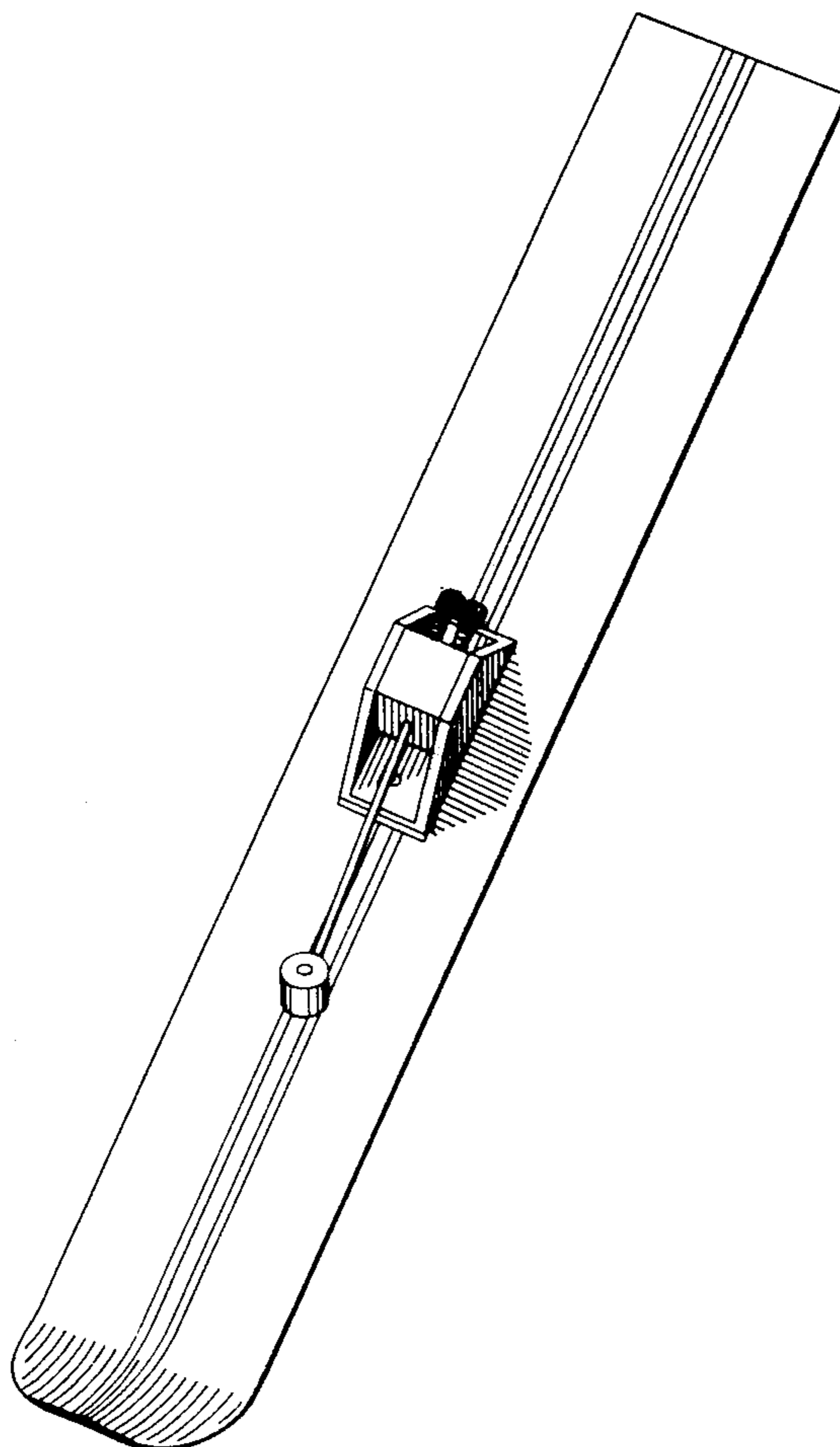

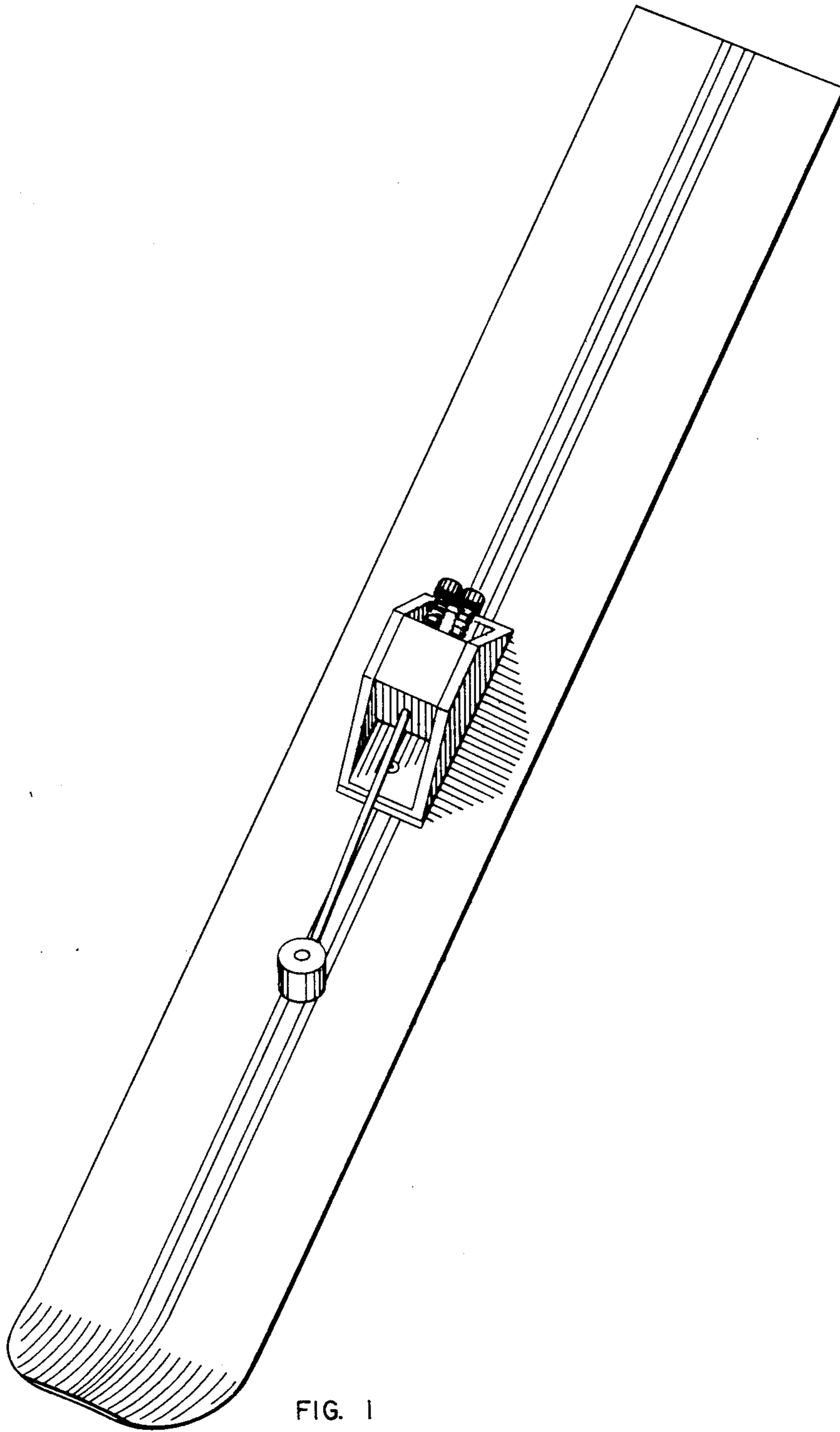

FIG. 1

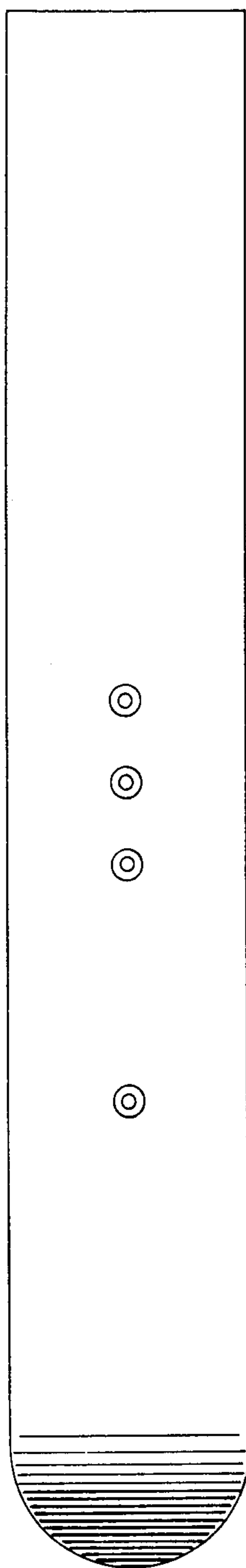

FIG. 2

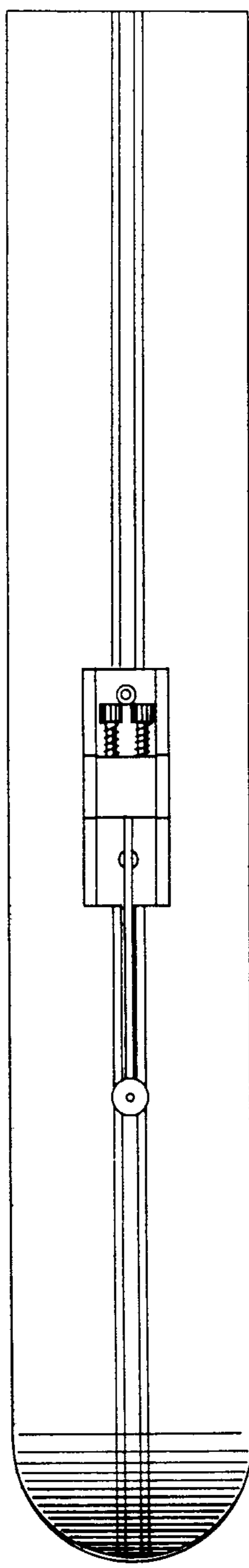

FIG. 3

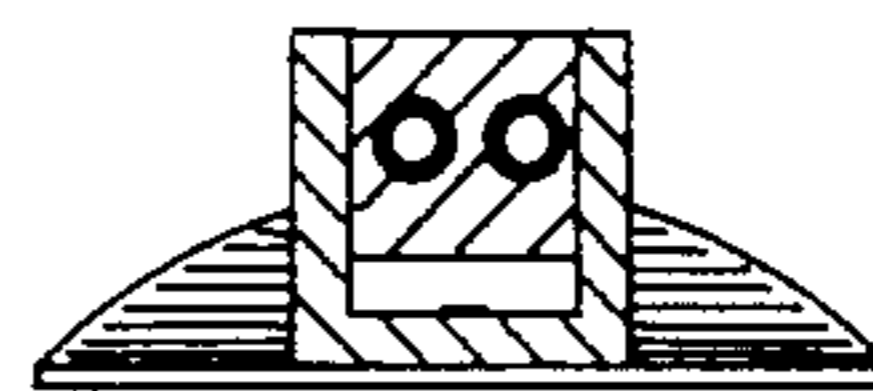

FIG. 4

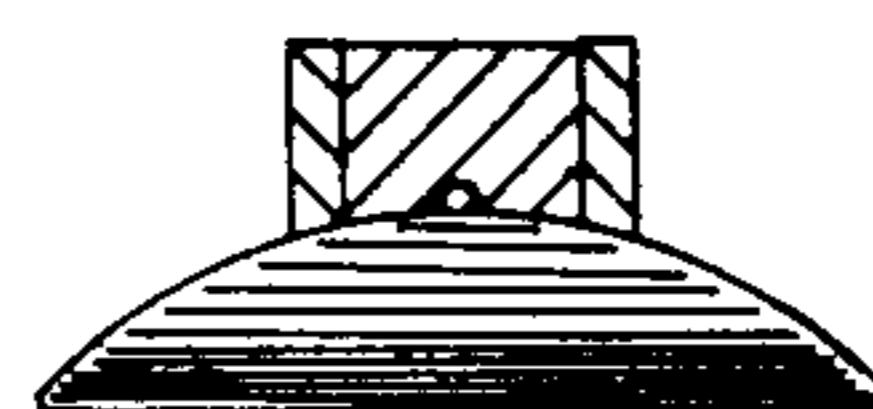

FIG. 5

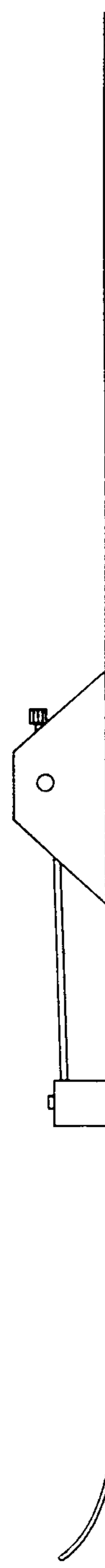

FIG. 6