

[54] COMBINED LENS CABINET AND WRITING DESK

[75] Inventor: Stephen U. Winig, Narberth, Pa.

[73] Assignee: American Optical Corporation, Southbridge, Mass.

[**] Term: 14 Years

[21] Appl. No.: 893,659

[22] Filed: Apr. 4, 1978

[51] Int. Cl. D24-01; D6-04

[52] U.S. Cl. D24/1.1; D6/129; D6/159; D6/160; D6/166

[58] Field of Search D24/1.1; 312/209, 252; D6/129, 159, 160, 165, 166

[56] References Cited

U.S. PATENT DOCUMENTS

- D. 213,381 2/1969 Clerico D6/167
- D. 222,584 11/1971 Lieberman D24/1.1

Primary Examiner—Sam Rosen
Attorney, Agent, or Firm—Jeremiah J. Duggan

[57] CLAIM

The ornamental design for a combined lens cabinet and writing desk, as shown and described.

DESCRIPTION

FIG. 1 is an illustration, in perspective, of the combined lens cabinet and writing desk embodying my new design;

FIG. 2 is a top plan view thereof;

FIG. 3 is another top plan view thereof with the uppermost drawer opened to expose a writing desk;

FIG. 4 is a rear elevational view thereof;

FIG. 5 is a view of one side thereof as it appears with all drawers closed, its opposite side having substantially the same appearance; and

FIG. 6 is a view of one side of the cabinet with the uppermost drawer open to expose the writing desk partially lifted to provide access to the drawer beneath.

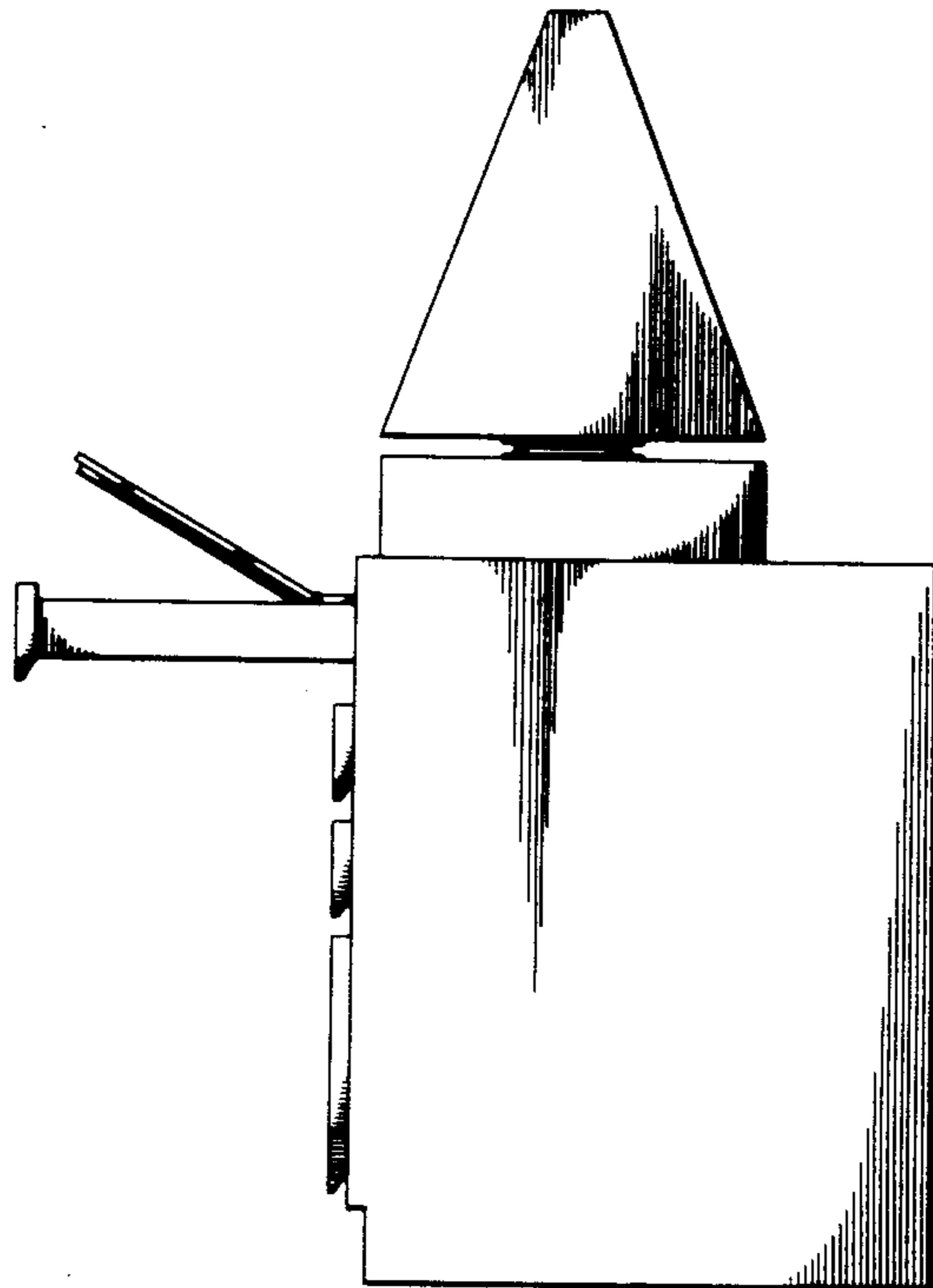

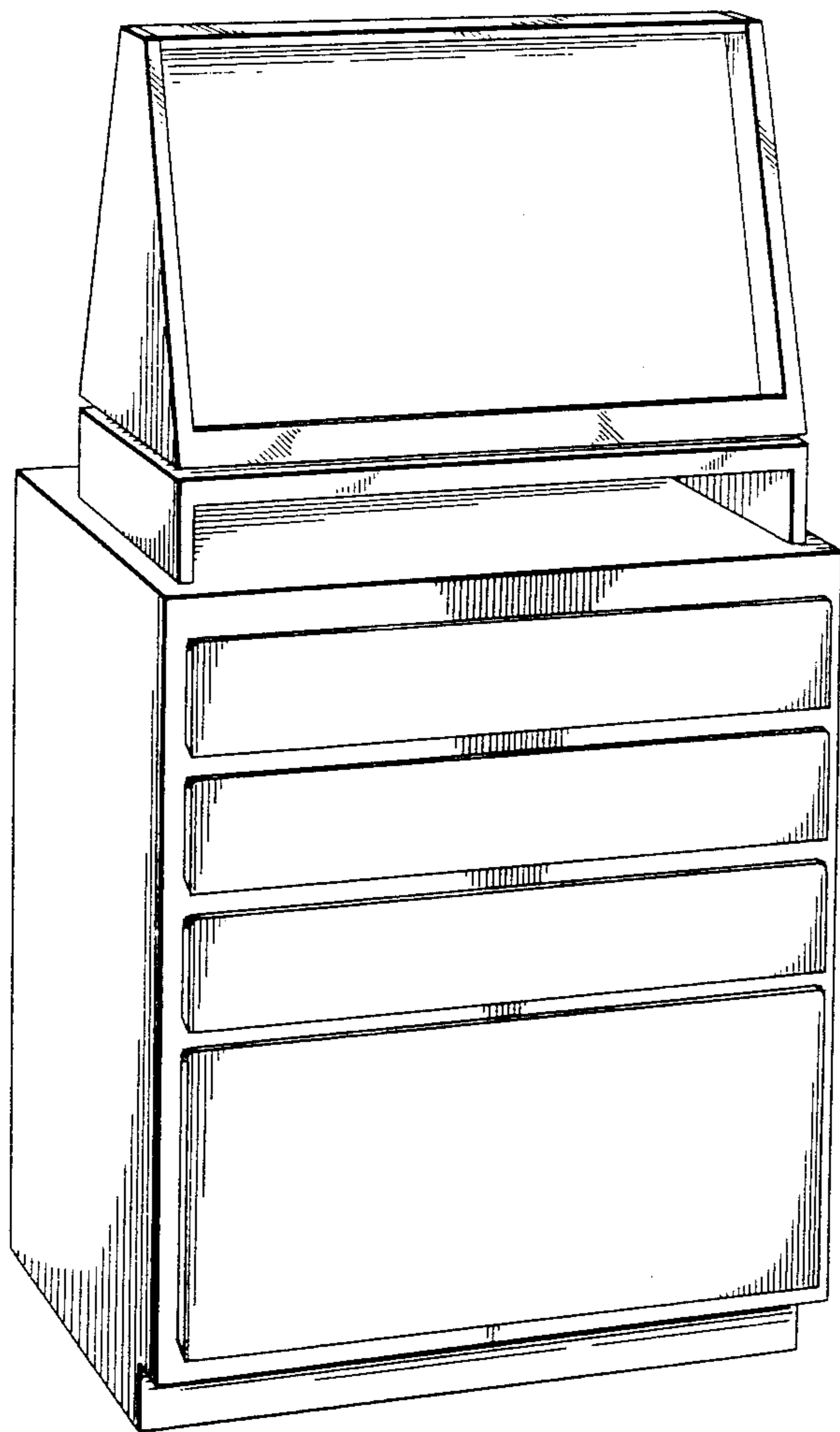

Fig. 1

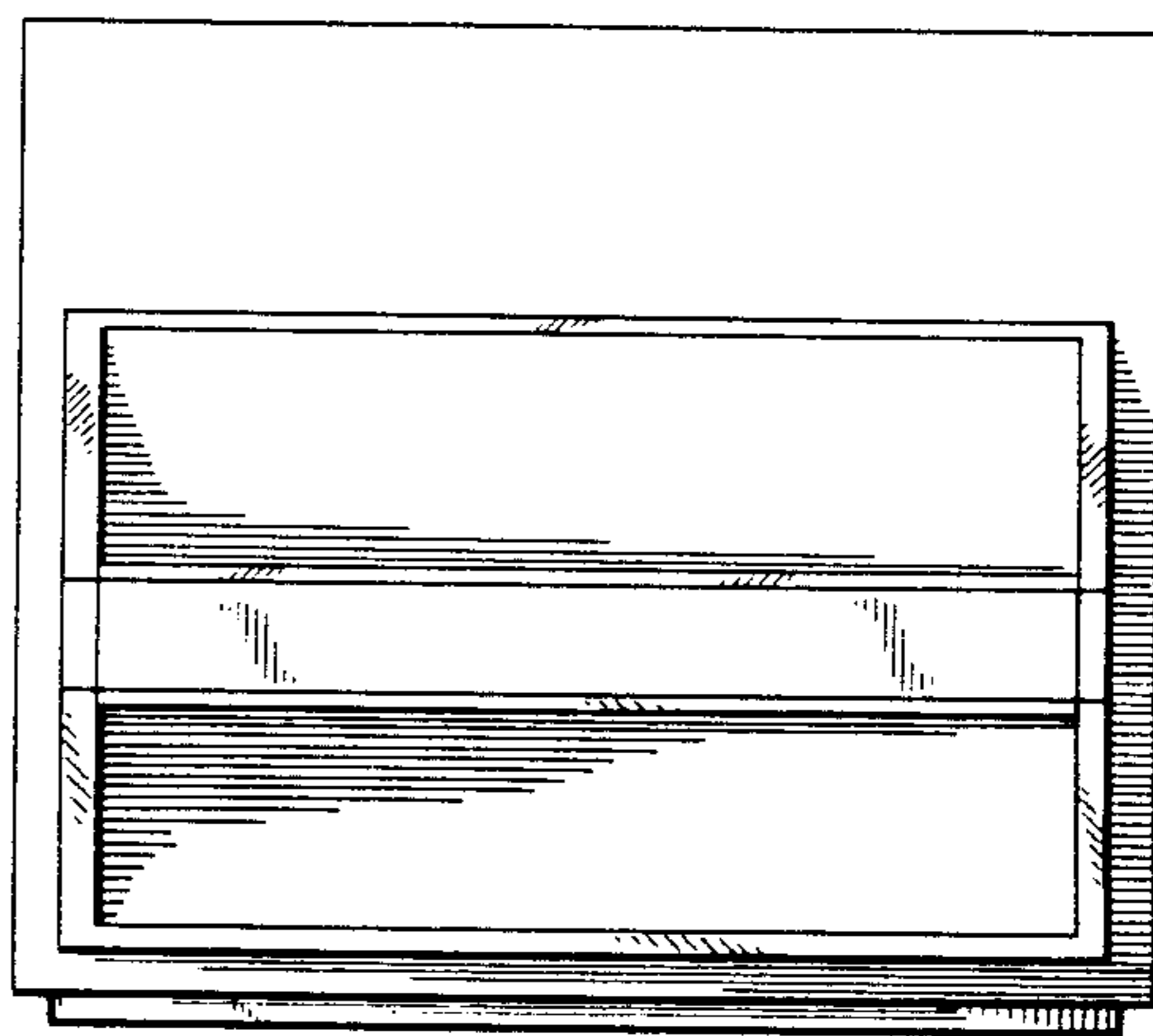

Fig. 2

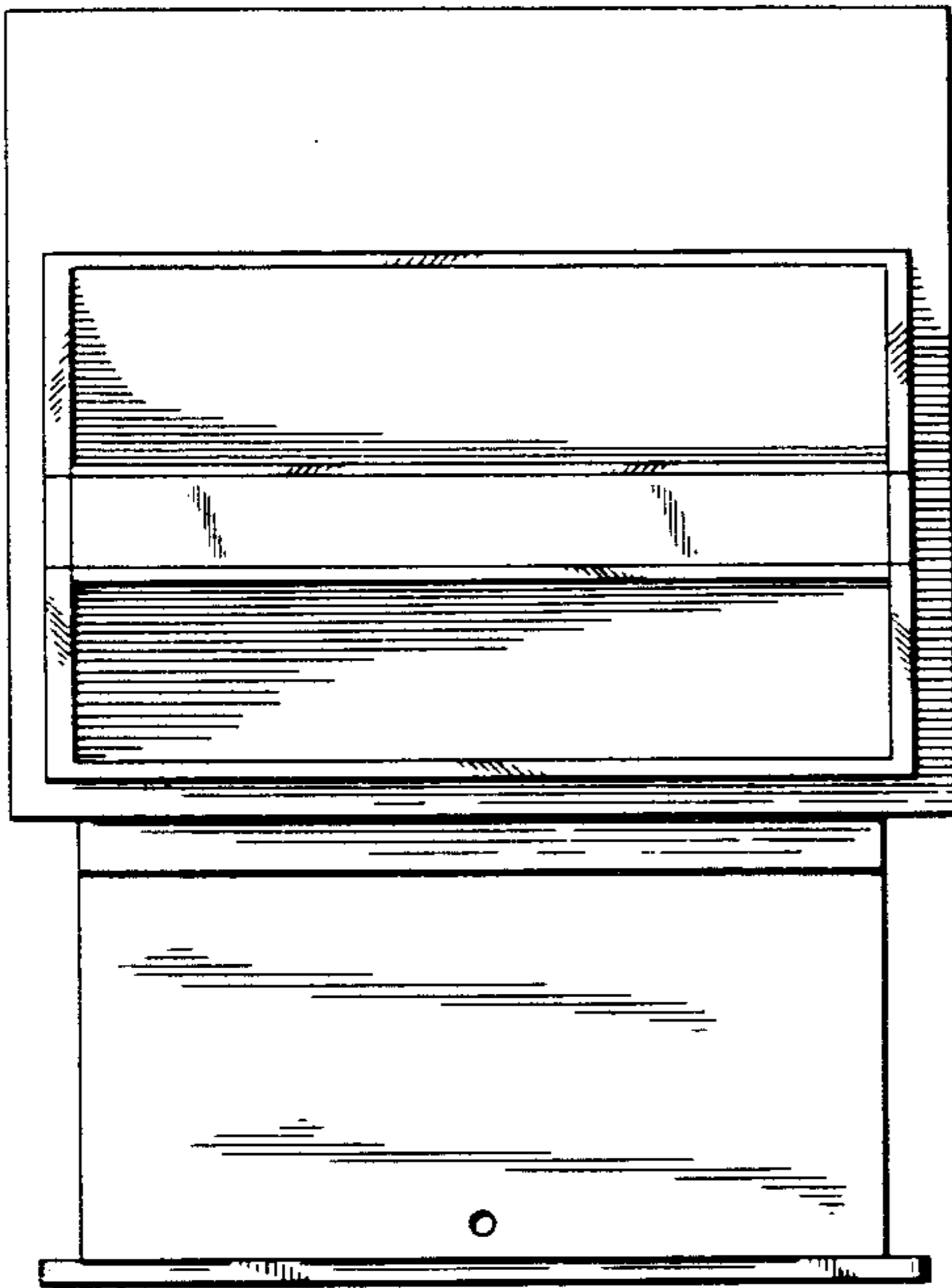

Fig. 3

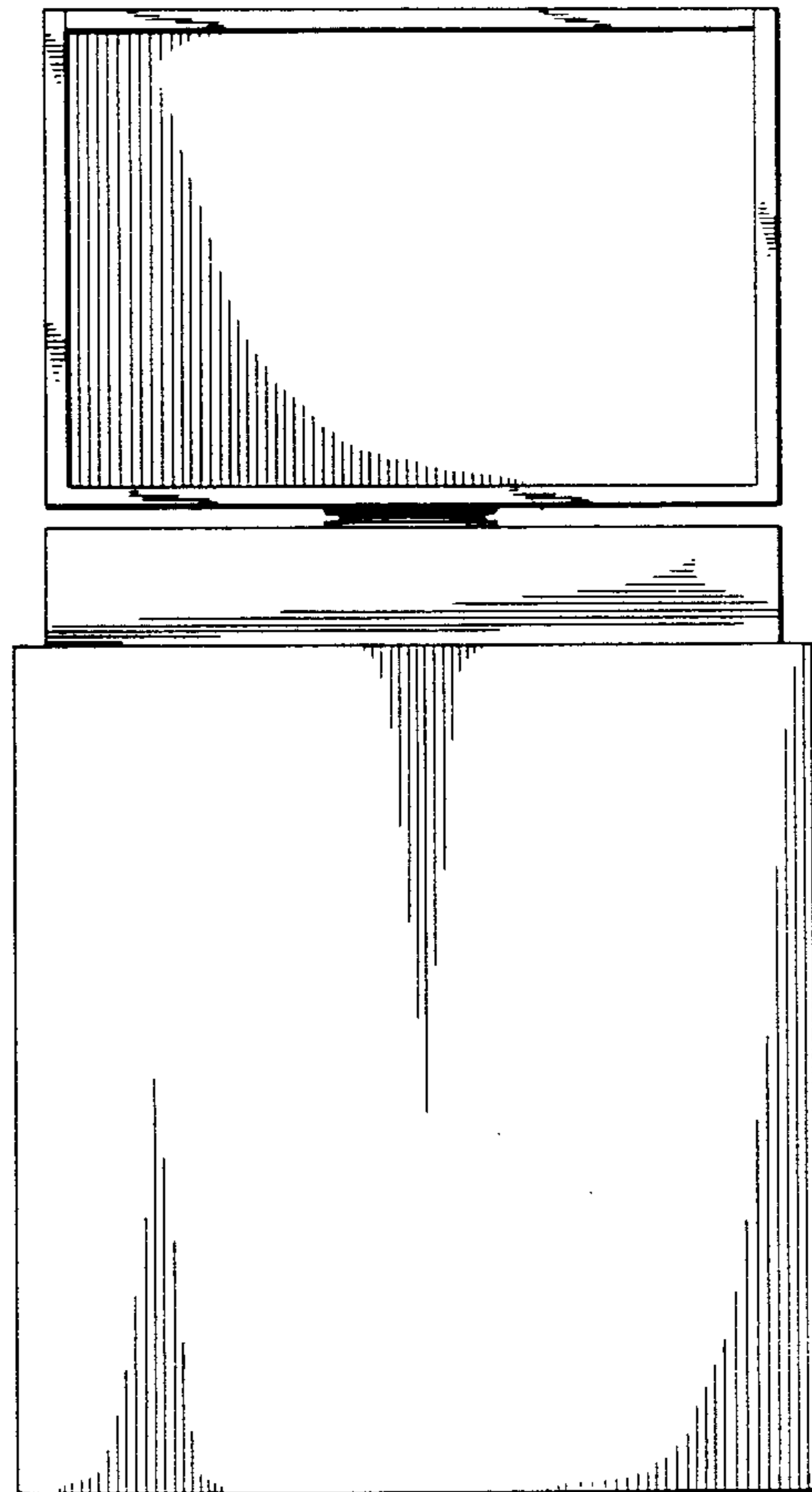

Fig. 4

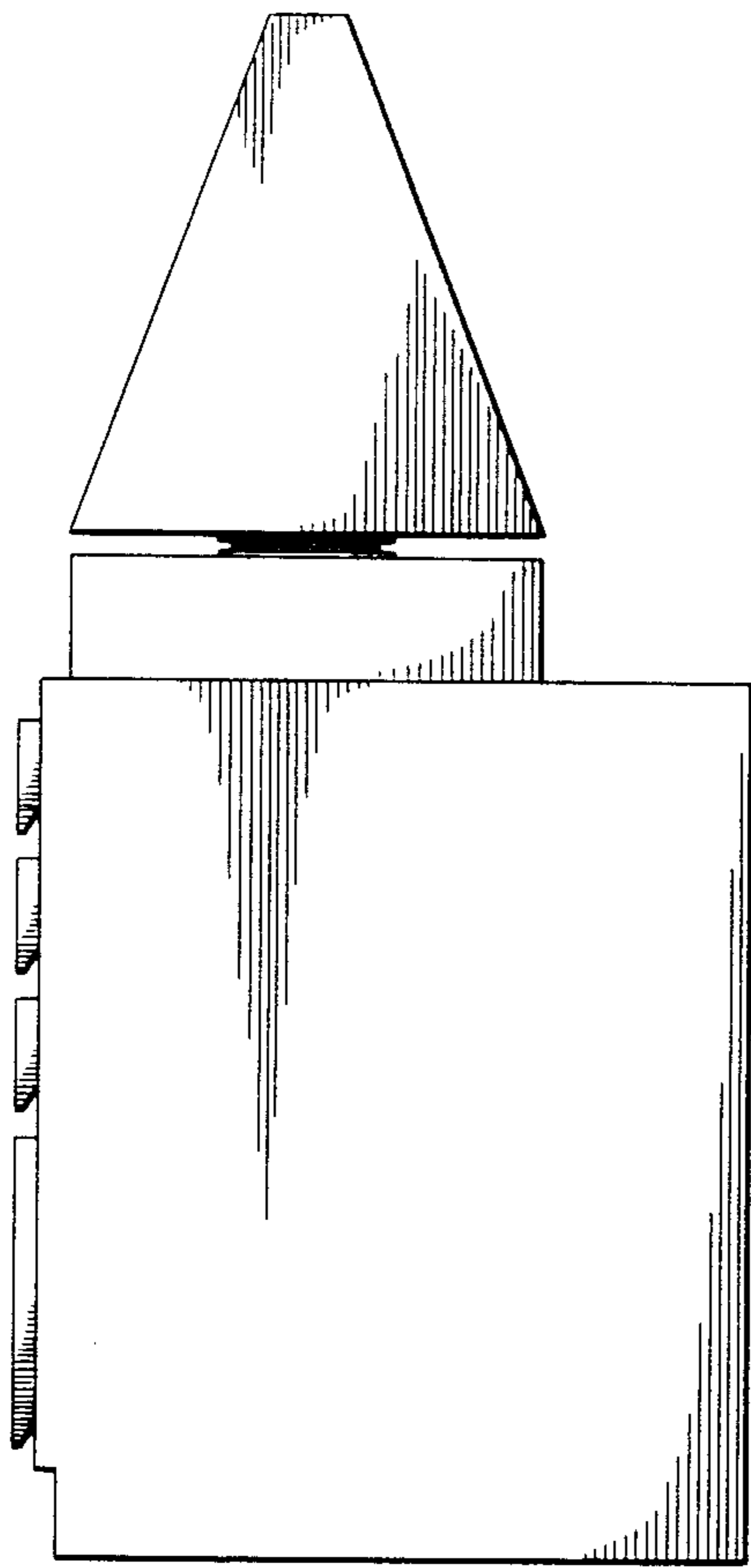

Fig. 5

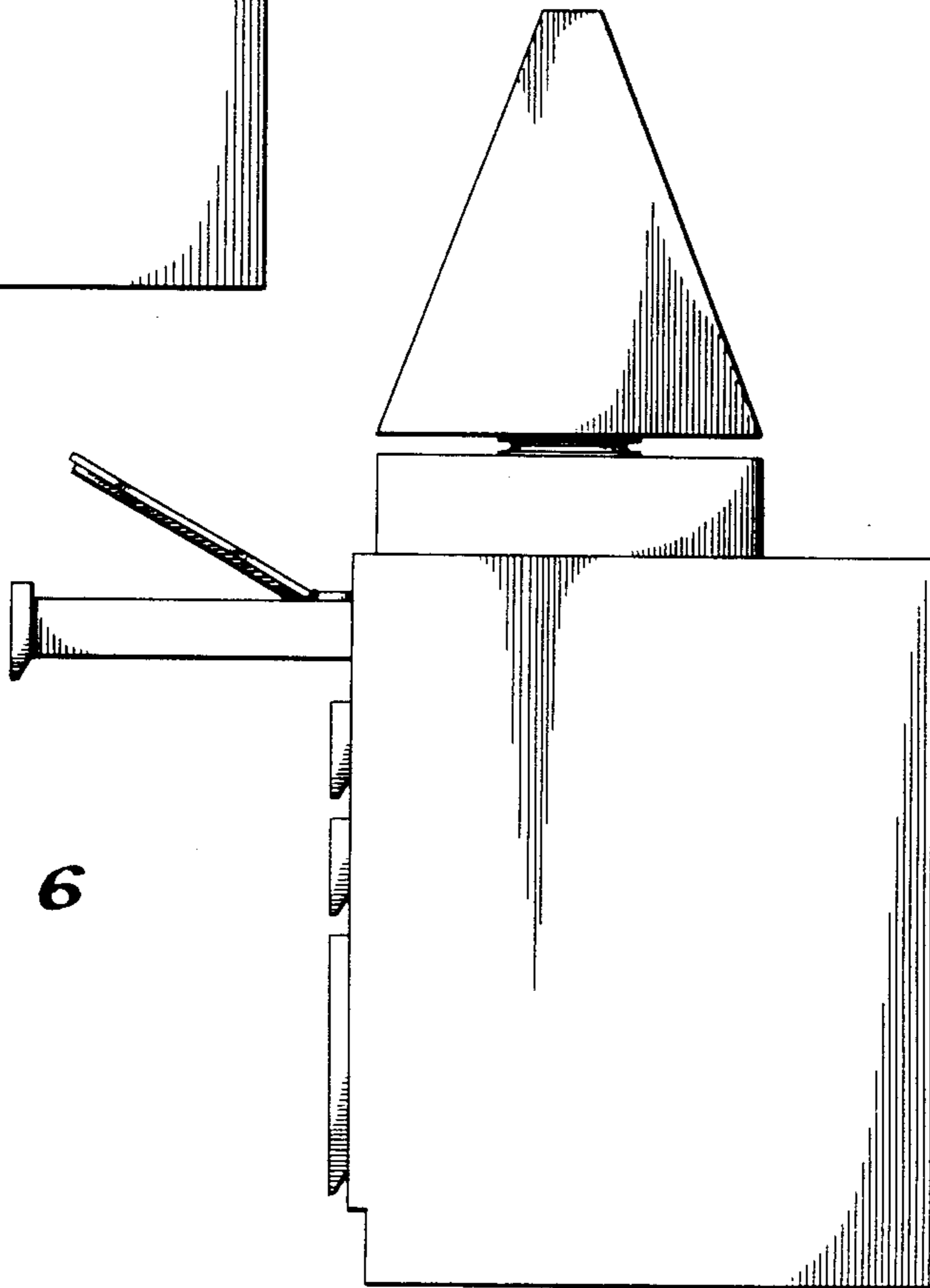

Fig. 6