

[54] **RUNNING BOARD**

[76] Inventor: **Merlyn C. Okland**, 204 W. Broad St., Story City, Iowa 50248

[**] Term: **14 Years**

[21] Appl. No.: **969,370**

[22] Filed: **Dec. 14, 1978**

[51] Int. Cl. **D12-16**

[52] U.S. Cl. **D12/203**

[58] Field of Search **D12/203; D25/69; 280/163, 169; 296/1 F; 52/177, 179, 181; 182/228**

[56] **References Cited**

U.S. PATENT DOCUMENTS

1,928,682 10/1933 Bronson 280/163

OTHER PUBLICATIONS

Popular Science, 9/77, p. 105, Running Board, top right side of page.

J. C. Whitney Catalog No. 366F, p. 33, Running Board, upper right side of page.

Primary Examiner—James M. Gandy

Attorney, Agent, or Firm—Donald H. Zarley

[57] **CLAIM**

The ornamental design for a running board, as shown and described.

DESCRIPTION

FIG. 1 is a perspective view of a running board showing my new design;

FIG. 2 is an enlarged top plan view thereof;

FIG. 3 is an enlarged bottom plan view thereof;

FIG. 4 is an enlarged front elevational view thereof;

FIG. 5 is an enlarged rear elevational view thereof;

FIG. 6 is an enlarged end elevational view thereof;

FIG. 7 is a perspective view of a running board showing a second embodiment of my new design;

FIG. 8 is an enlarged top plan view of FIG. 7;

FIG. 9 is an enlarged bottom plan view of FIG. 7;

FIG. 10 is an enlarged front elevational view of FIG. 7;

FIG. 11 is an enlarged rear elevational view of FIG. 7;

FIG. 12 is an enlarged left end elevational view of FIG. 7;

FIG. 13 is an enlarged right end elevational view of FIG. 7;

FIG. 14 is a perspective view of a running board showing a third embodiment of my new design;

FIG. 15 is an enlarged top plan view of FIG. 14;

FIG. 16 is an enlarged bottom plan view of FIG. 14;

FIG. 17 is an enlarged front elevational view of FIG. 14;

FIG. 18 is an enlarged rear elevational view of FIG. 14;

FIG. 19 is an enlarged left end elevational view of FIG. 14;

FIG. 20 is an enlarged right end elevational view of FIG. 14;

FIG. 21 is a perspective view of a running board showing a fourth embodiment of my new design;

FIG. 22 is an enlarged top plan view of FIG. 21;

FIG. 23 is an enlarged bottom plan view of FIG. 21;

FIG. 24 is an enlarged front elevational view of FIG. 21;

FIG. 25 is an enlarged rear elevational view of FIG. 21; and

FIG. 26 is an enlarged end elevational view of FIG. 21.

The running board has been broken away in the center in FIGS. 2, 3, 4, 5, 8, 9, 10, 11, 15, 16, 17, 18, 22, 23, 24, 25 and the mud flap portion has been broken away in the center in FIGS. 10 and 11 for convenience of illustration.

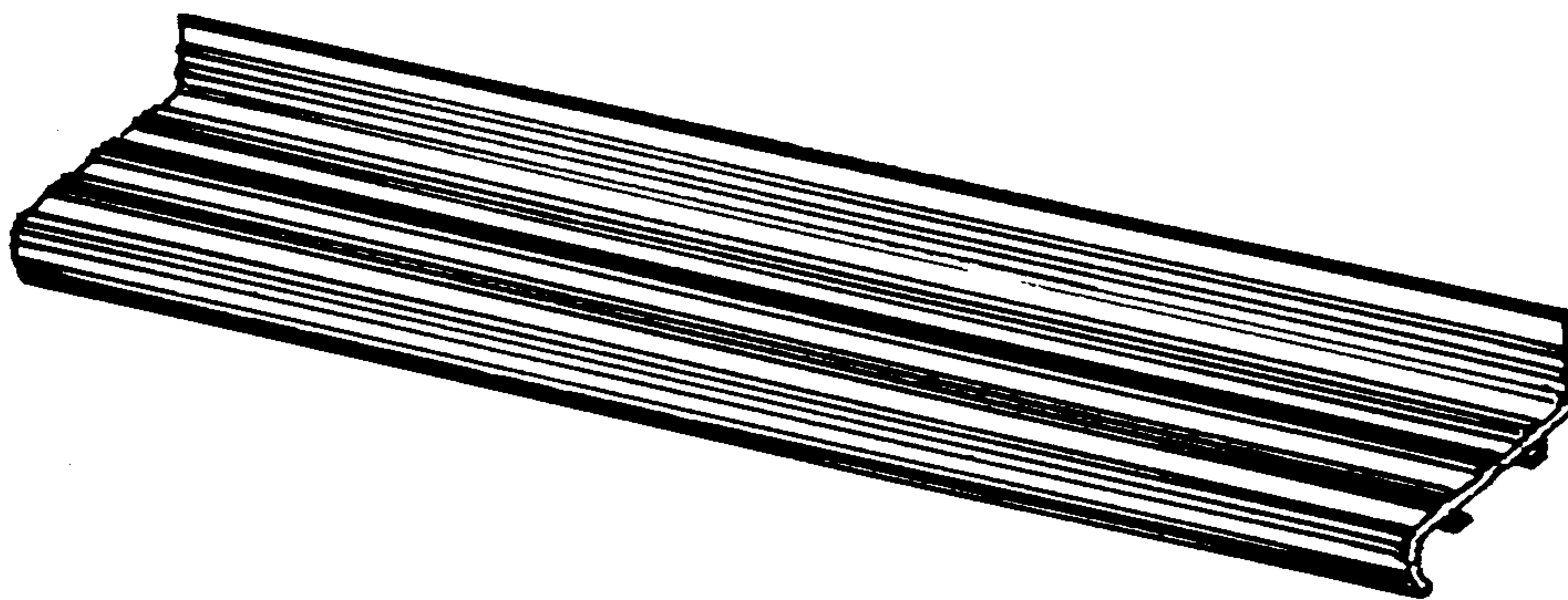

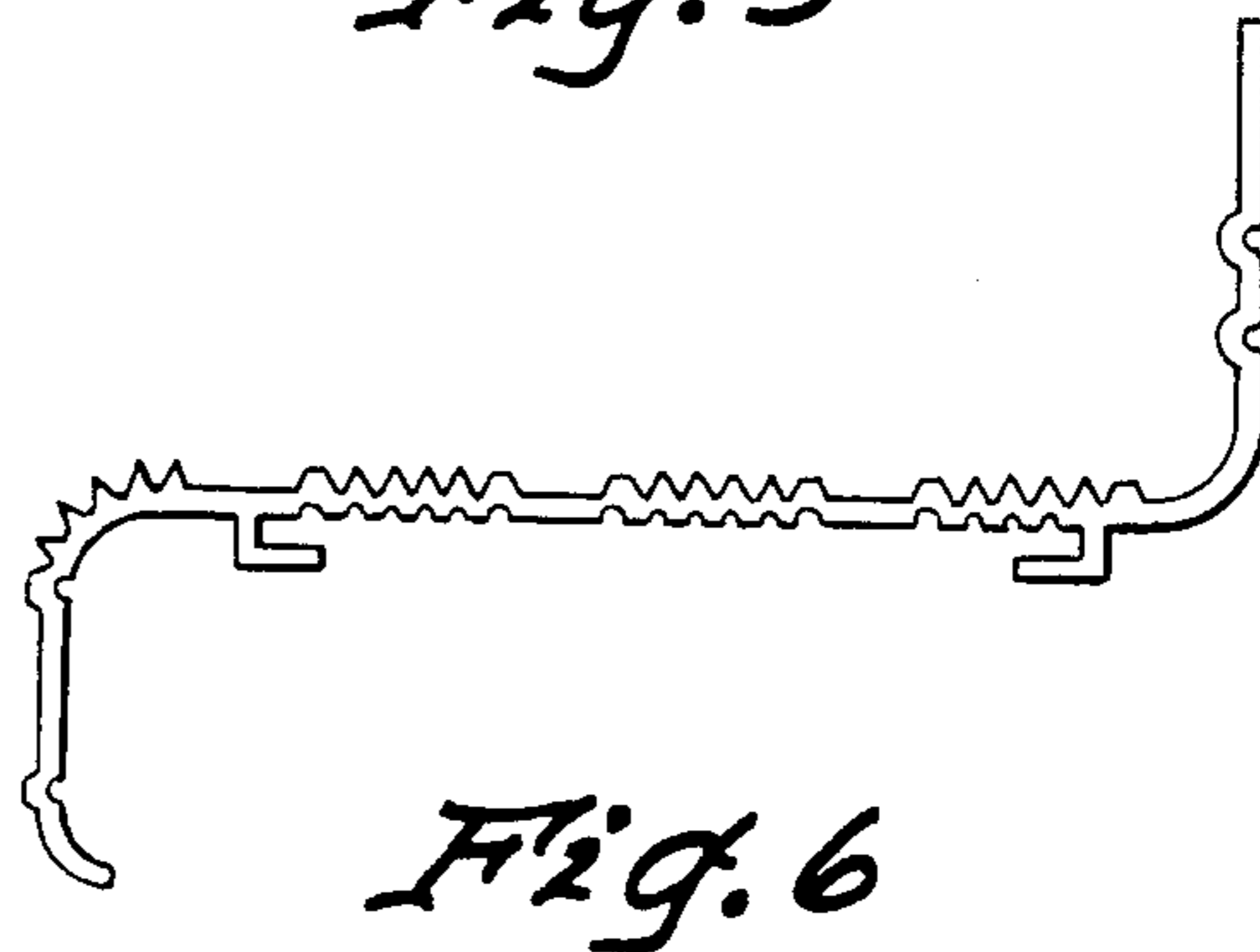
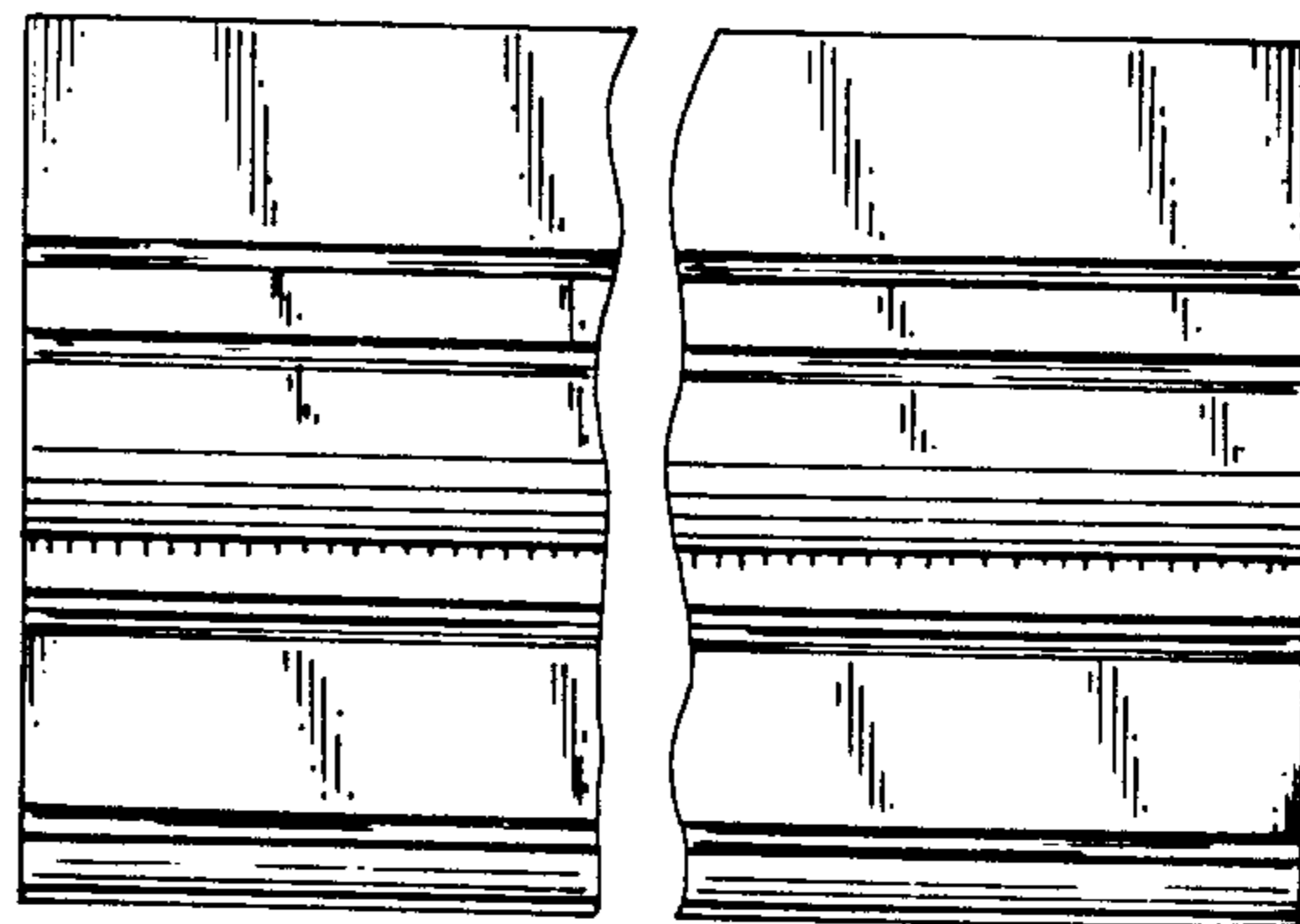
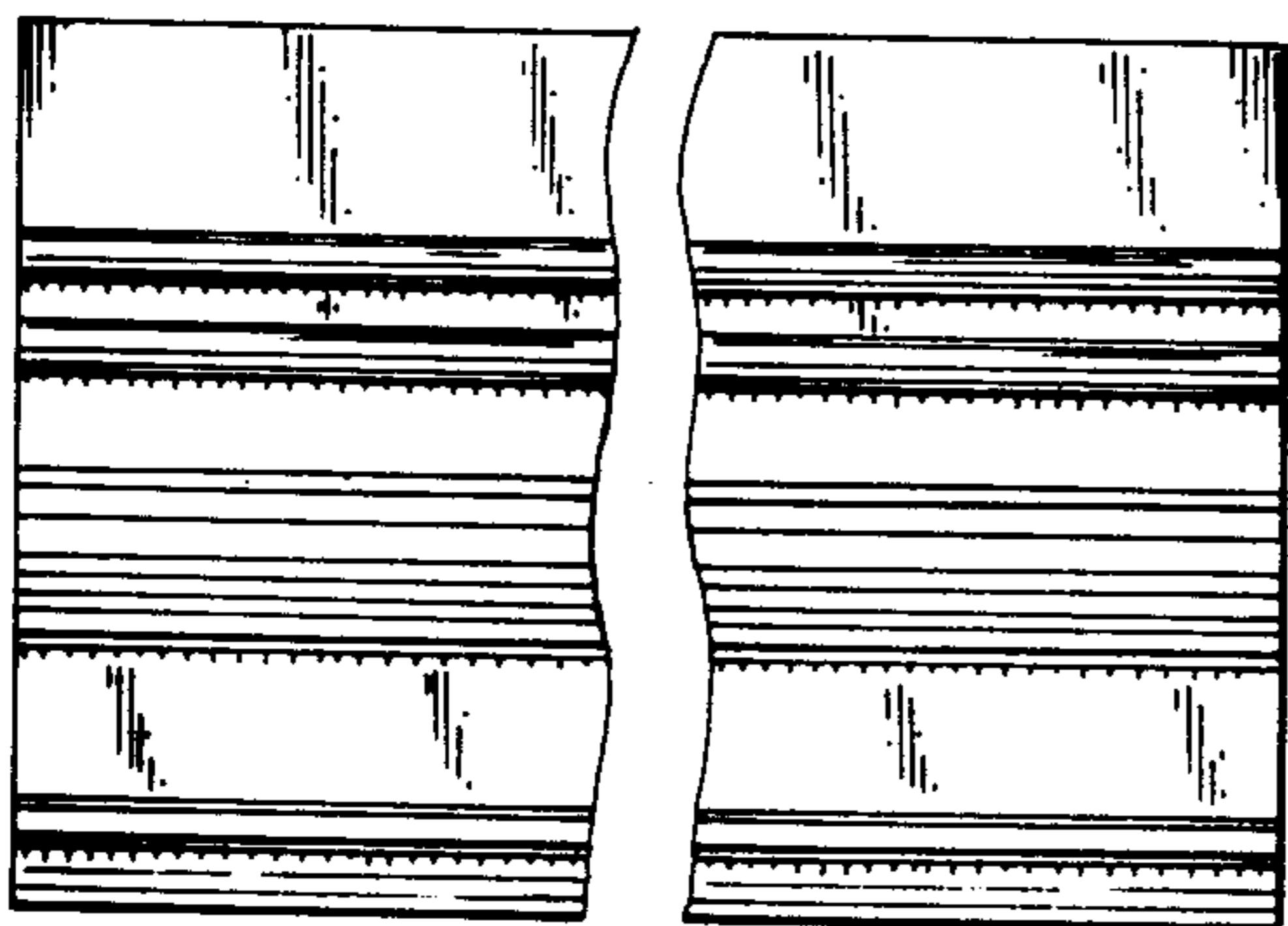
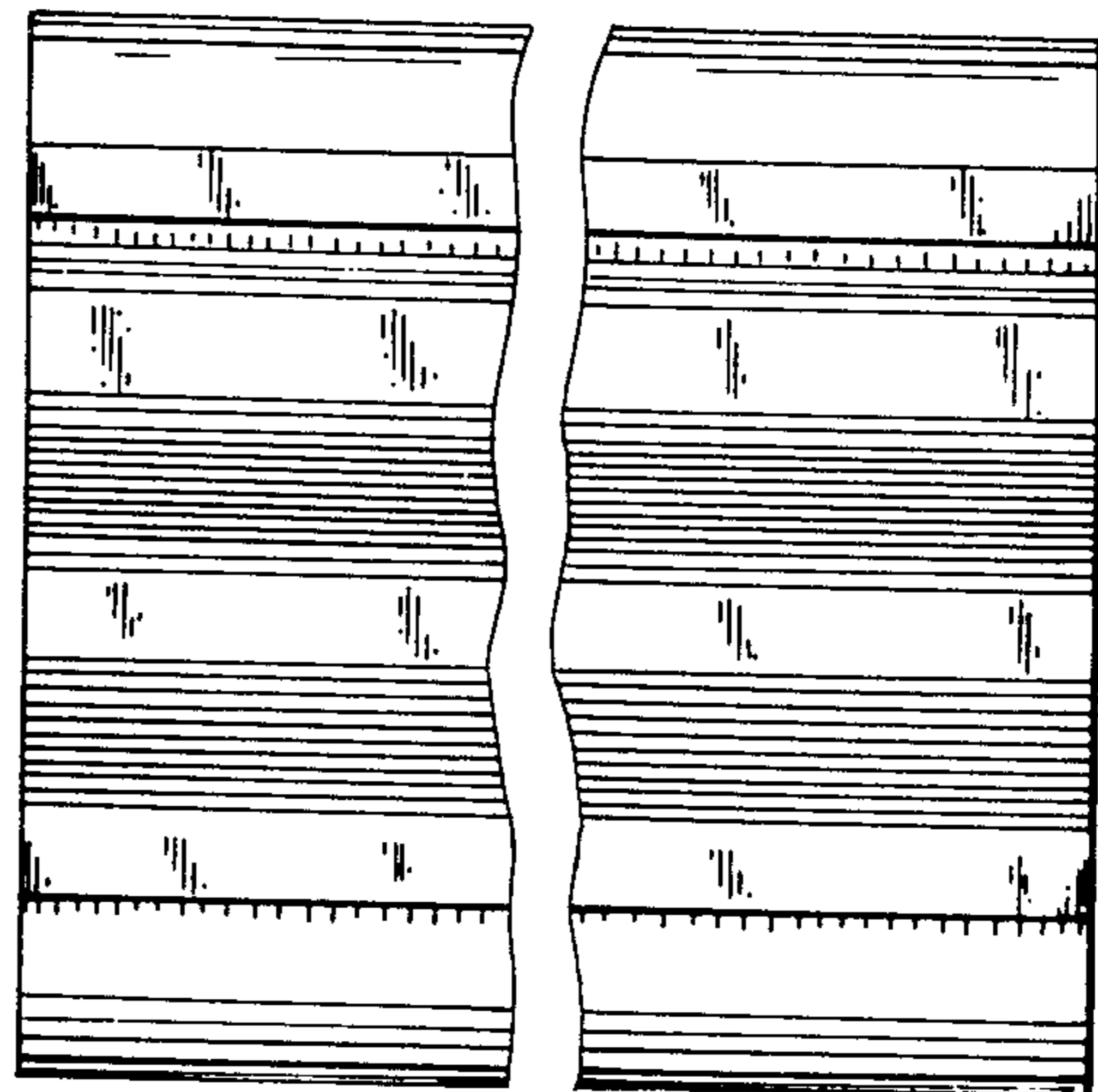
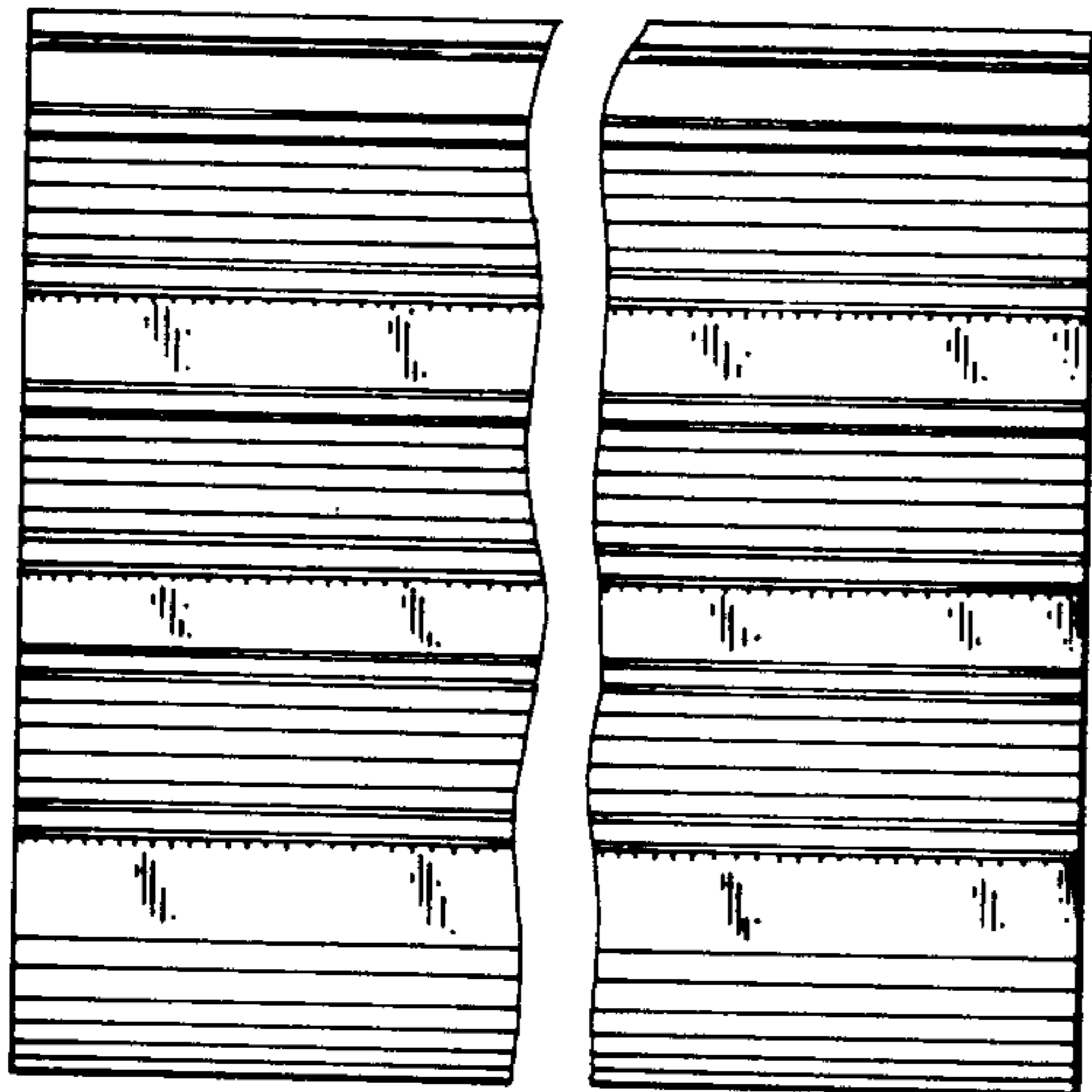

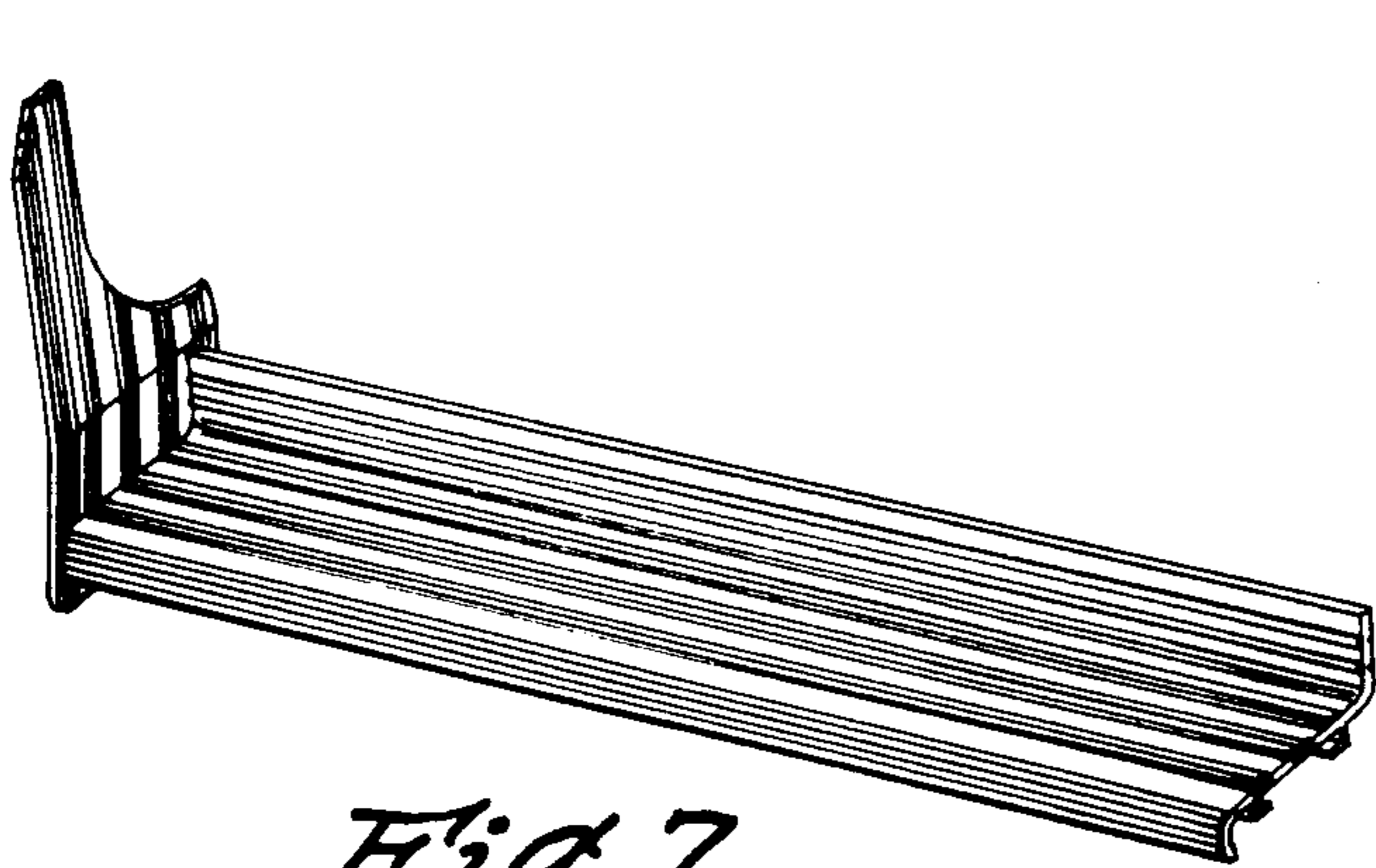

Fig. 7

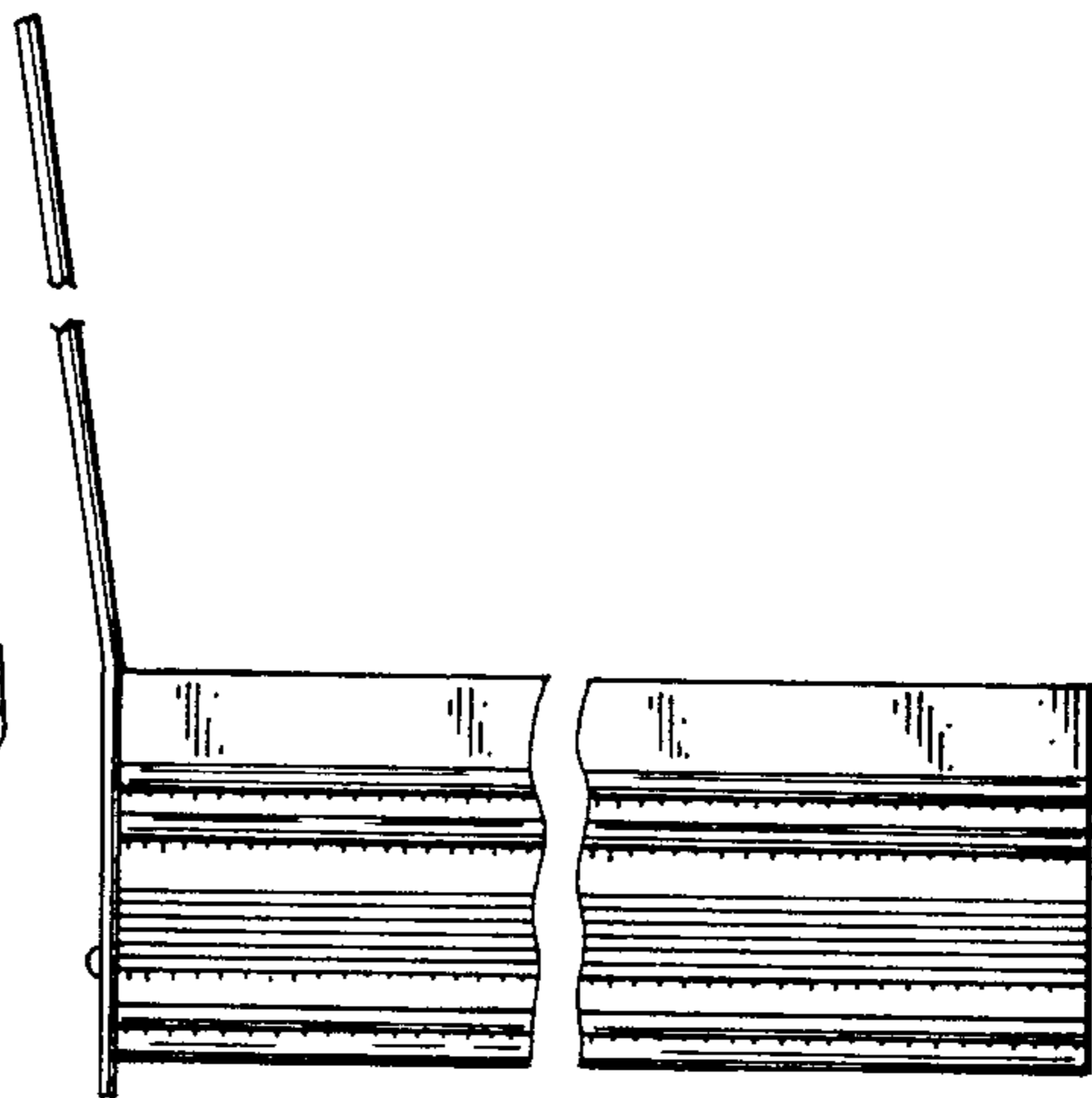

Fig. 10

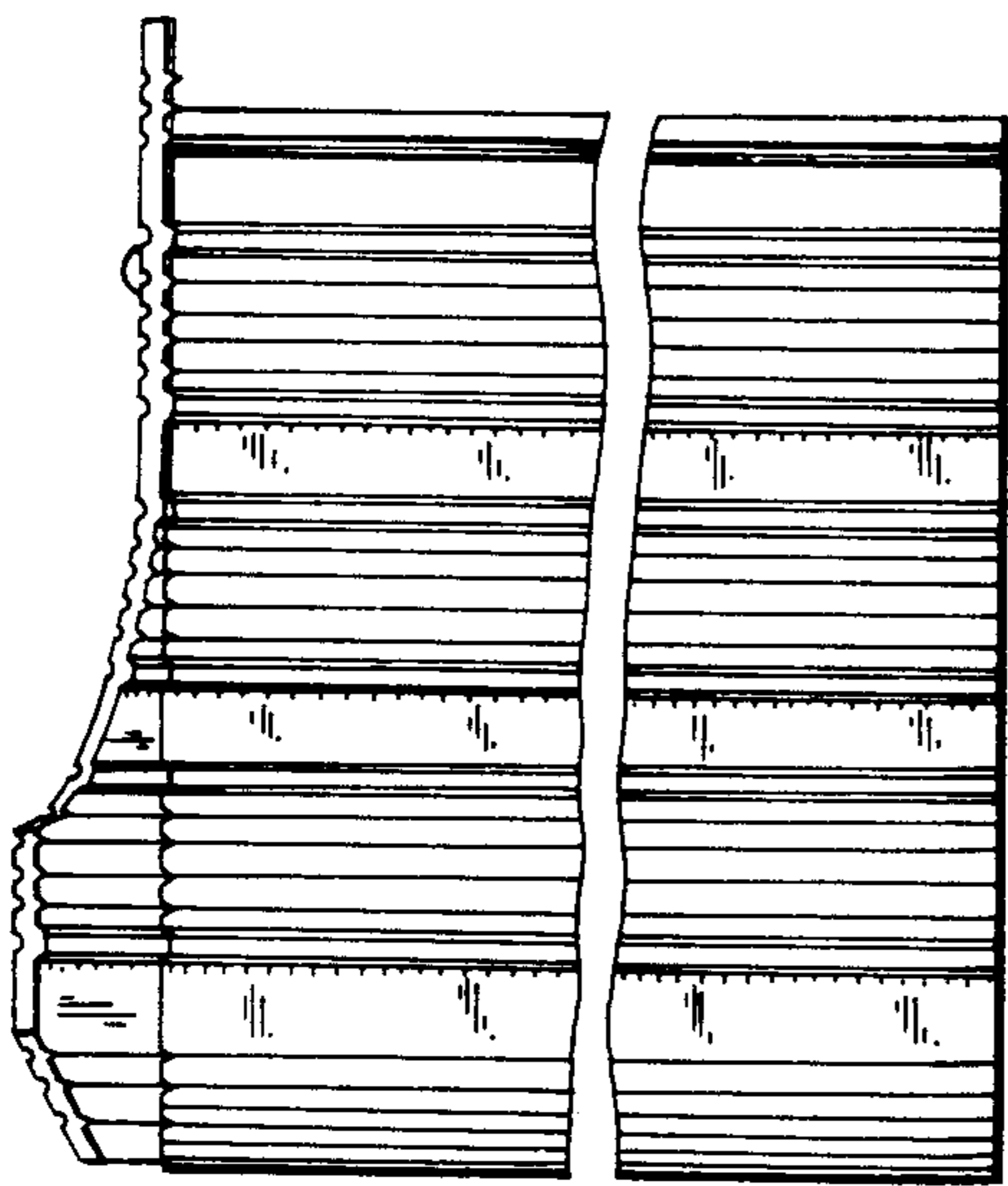

Fig. 8

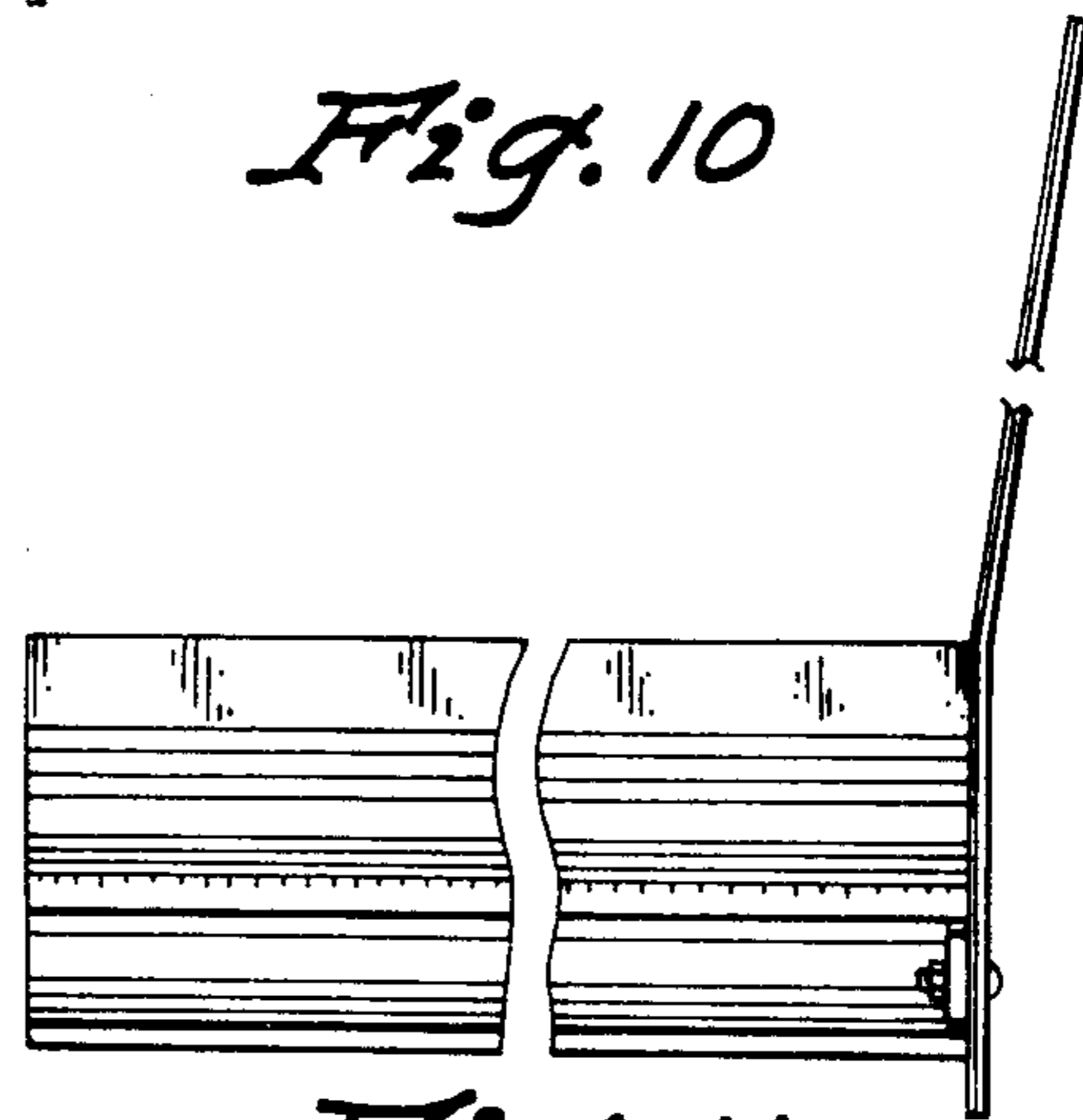

Fig. 11

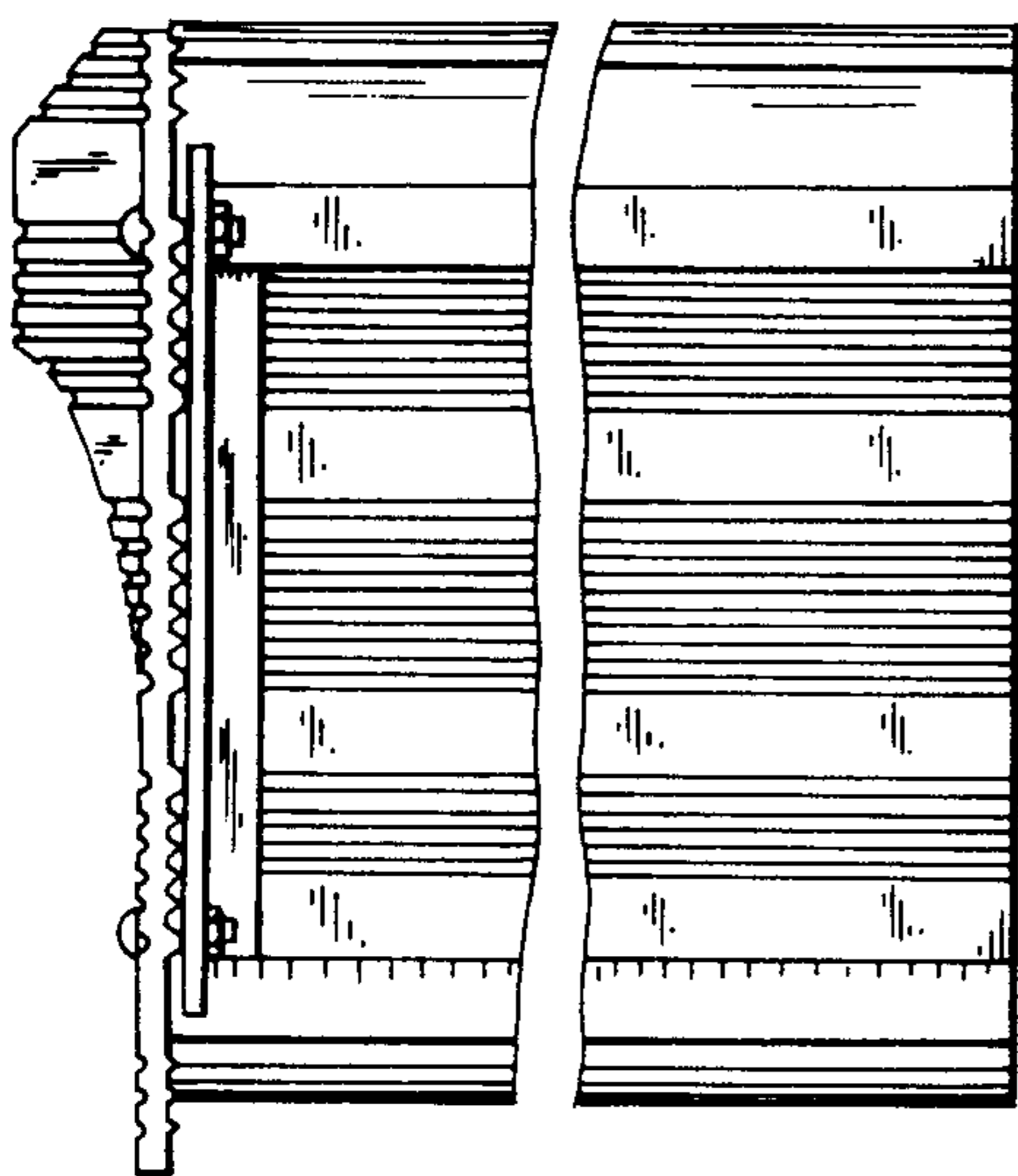

Fig. 9

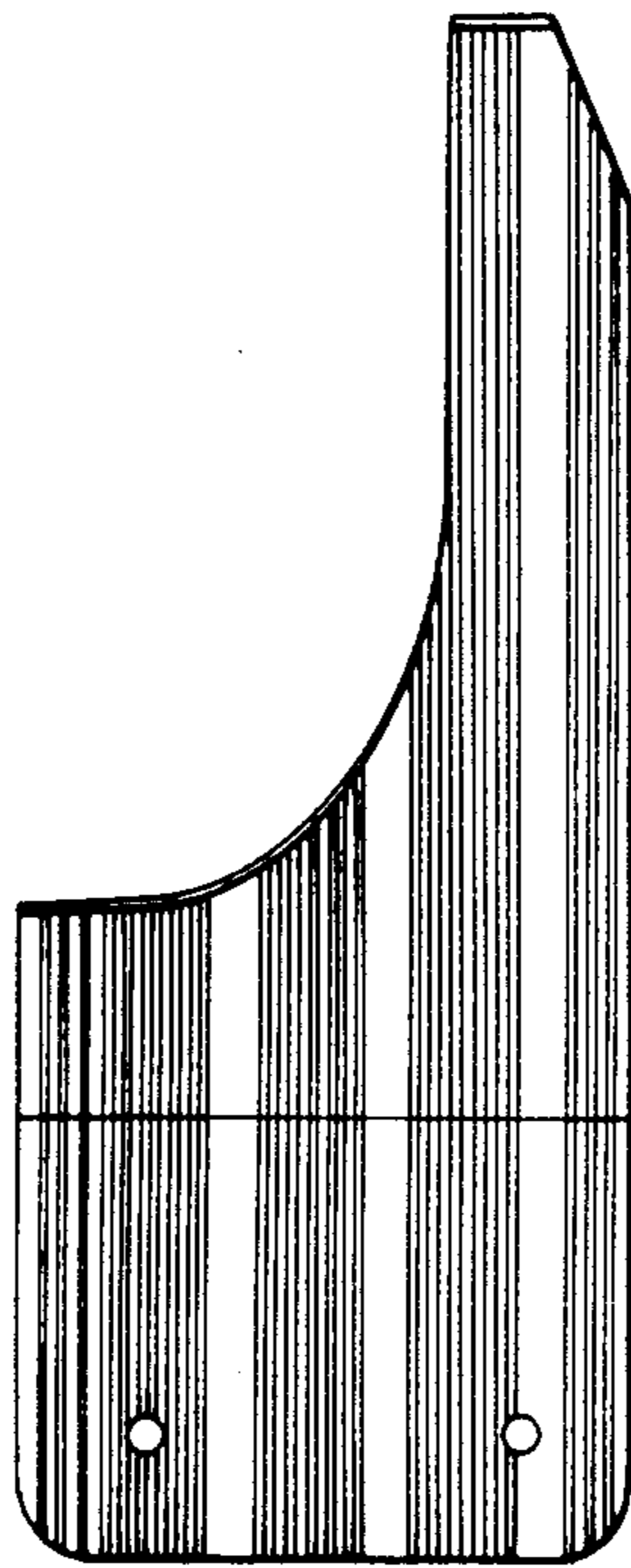

Fig. 12

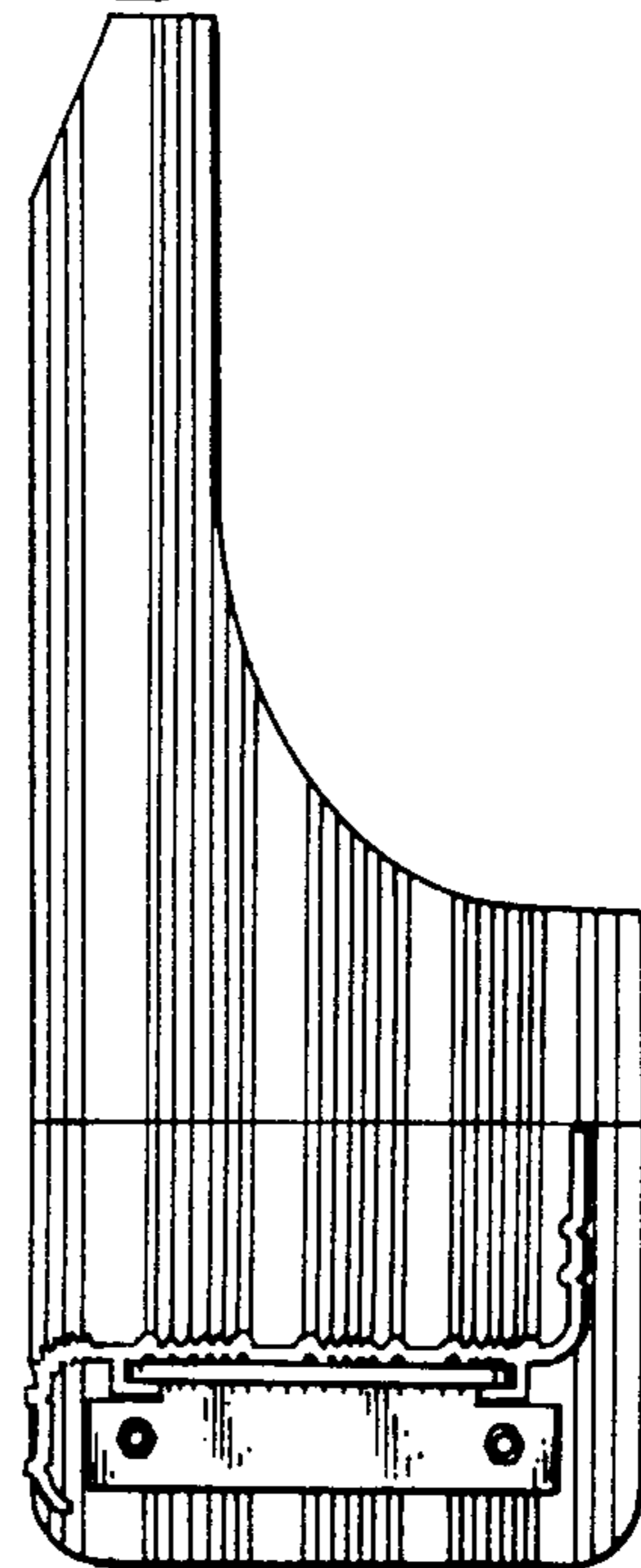
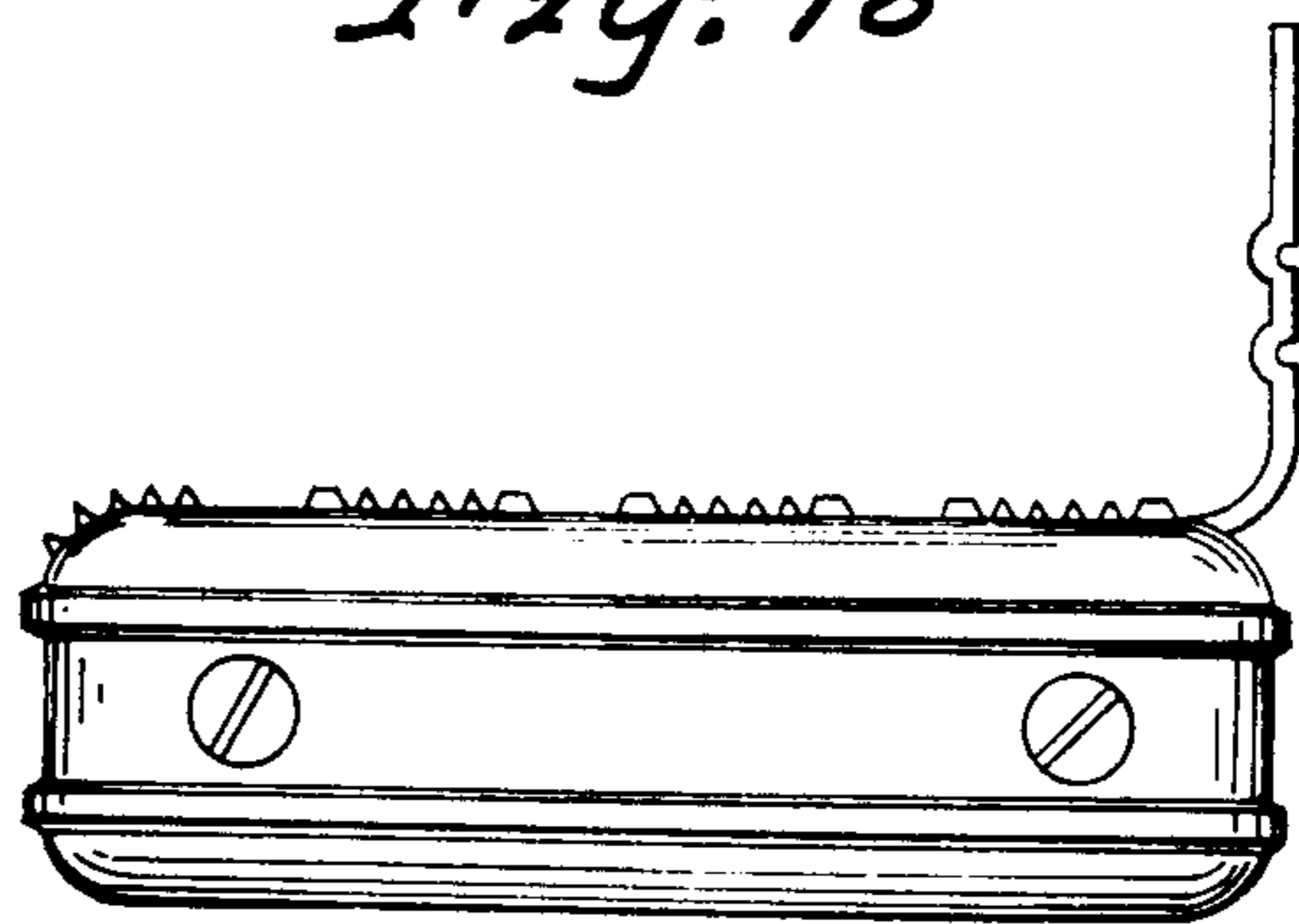
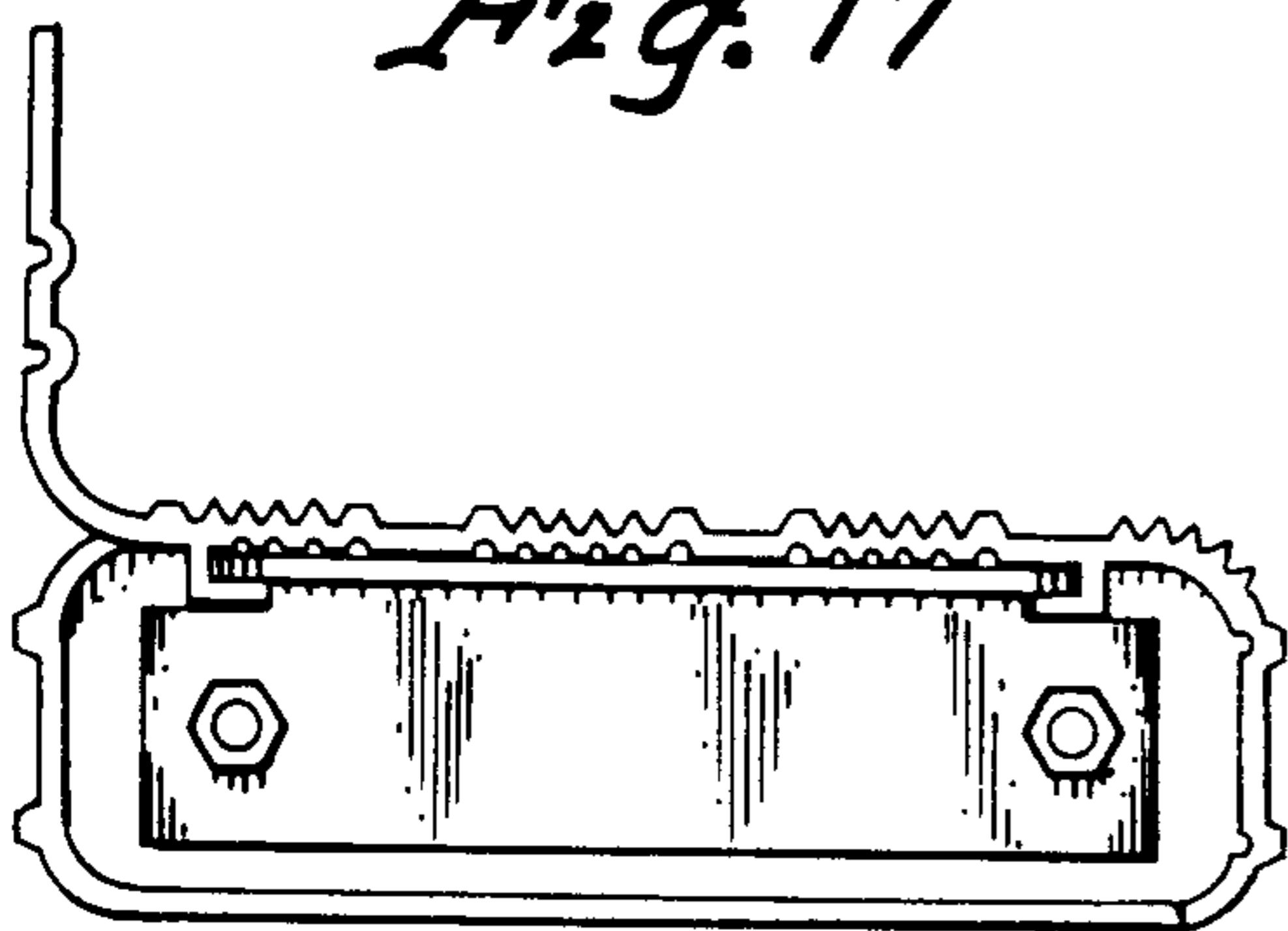
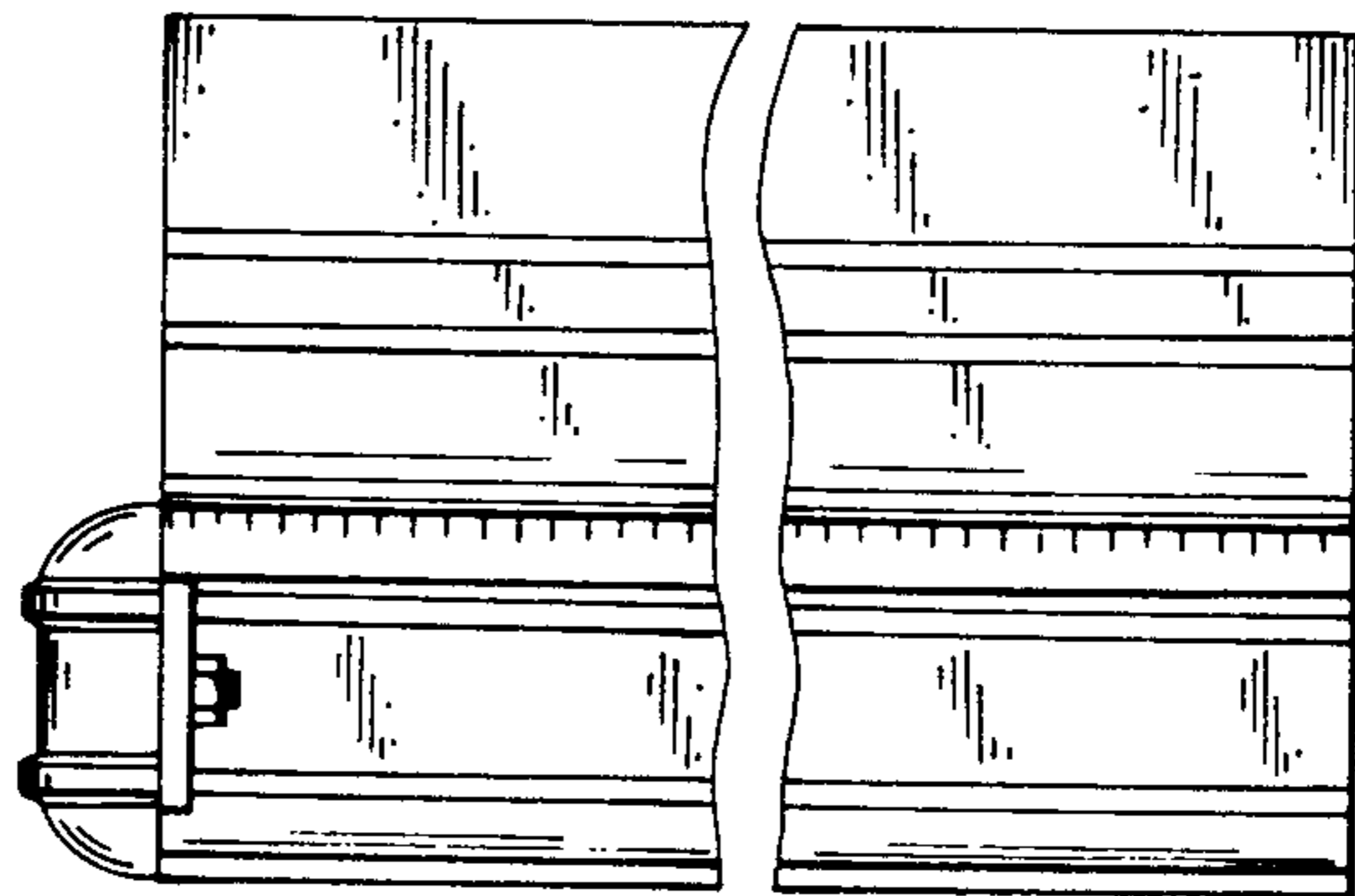
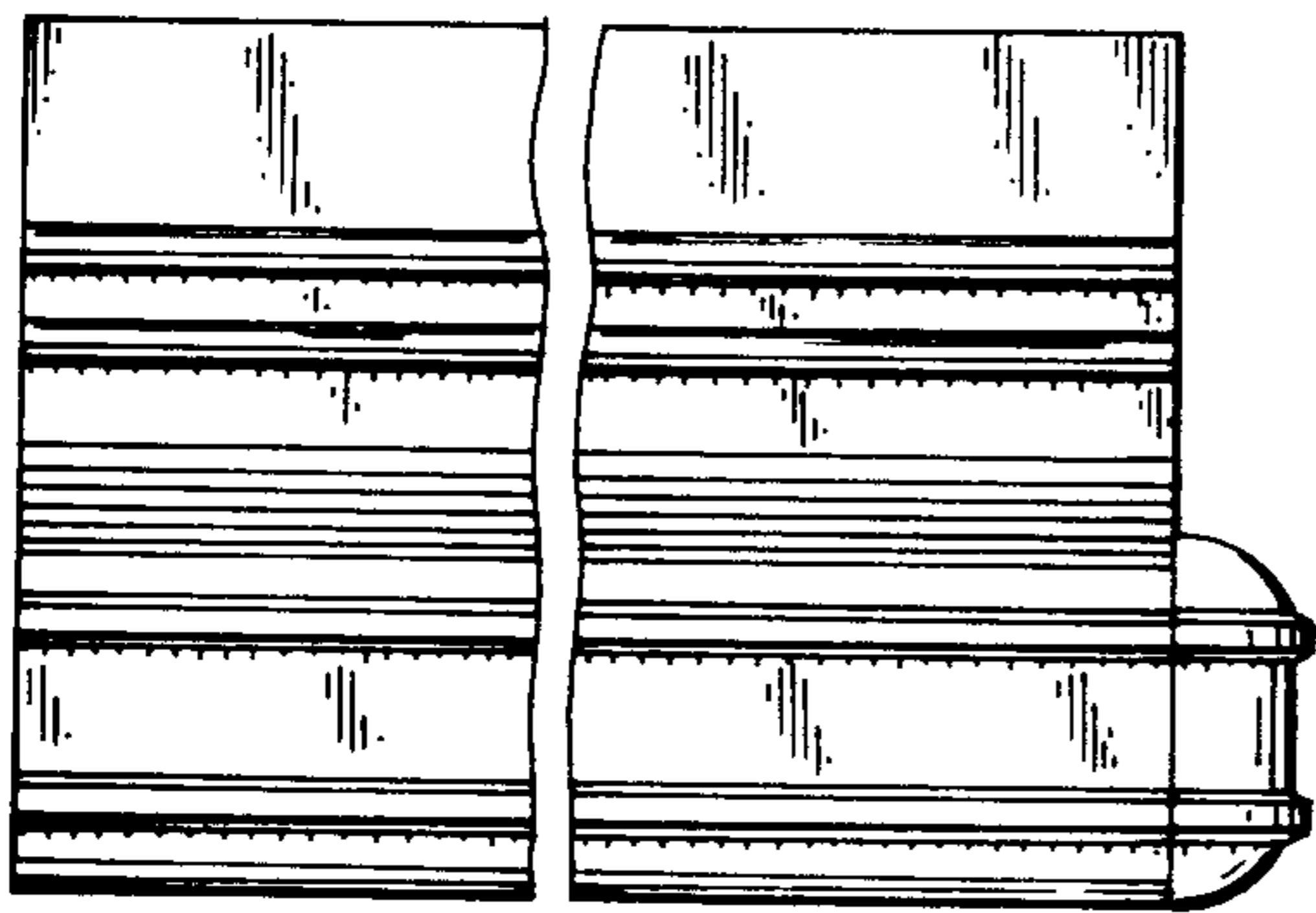
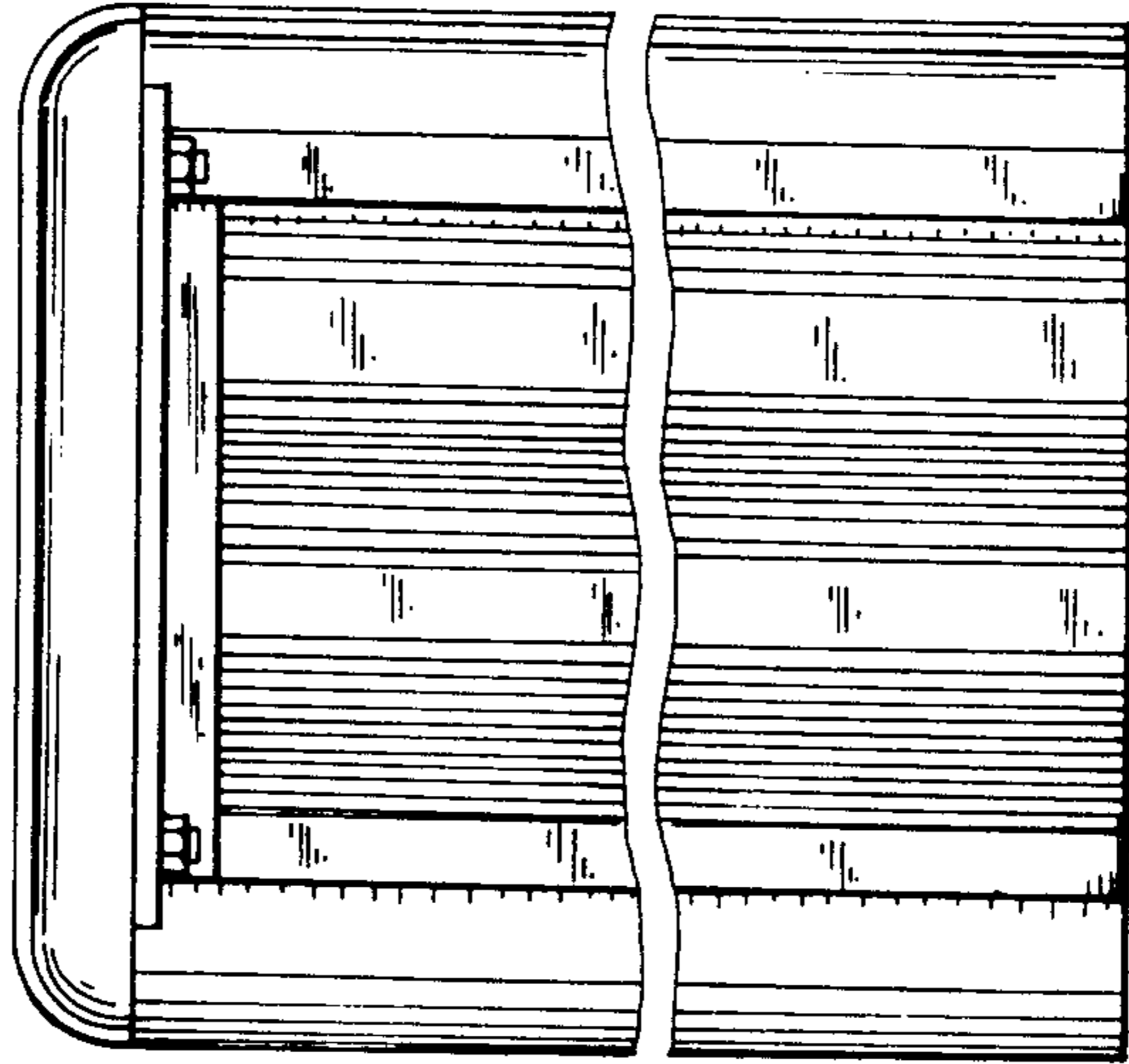
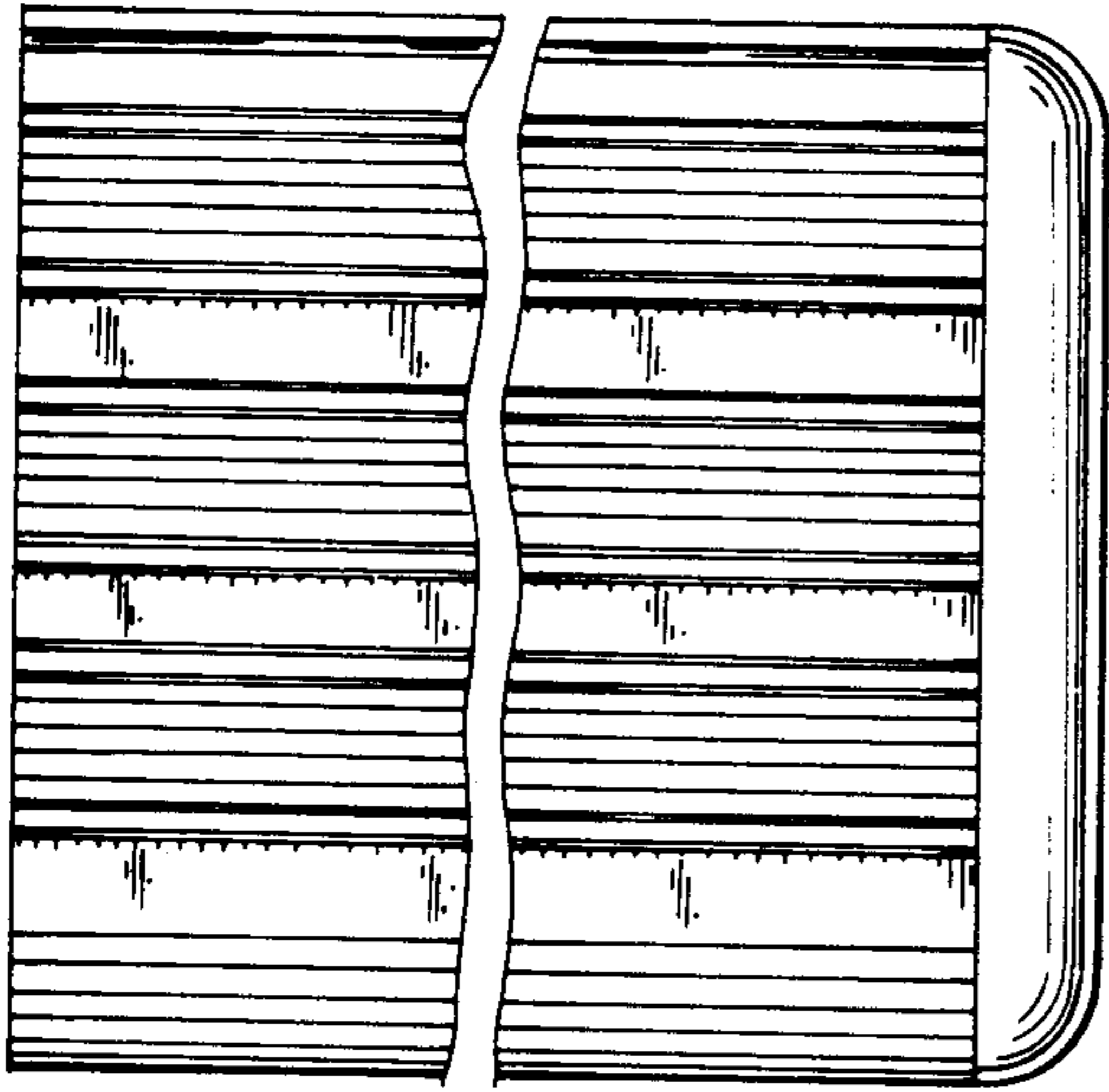

Fig. 13



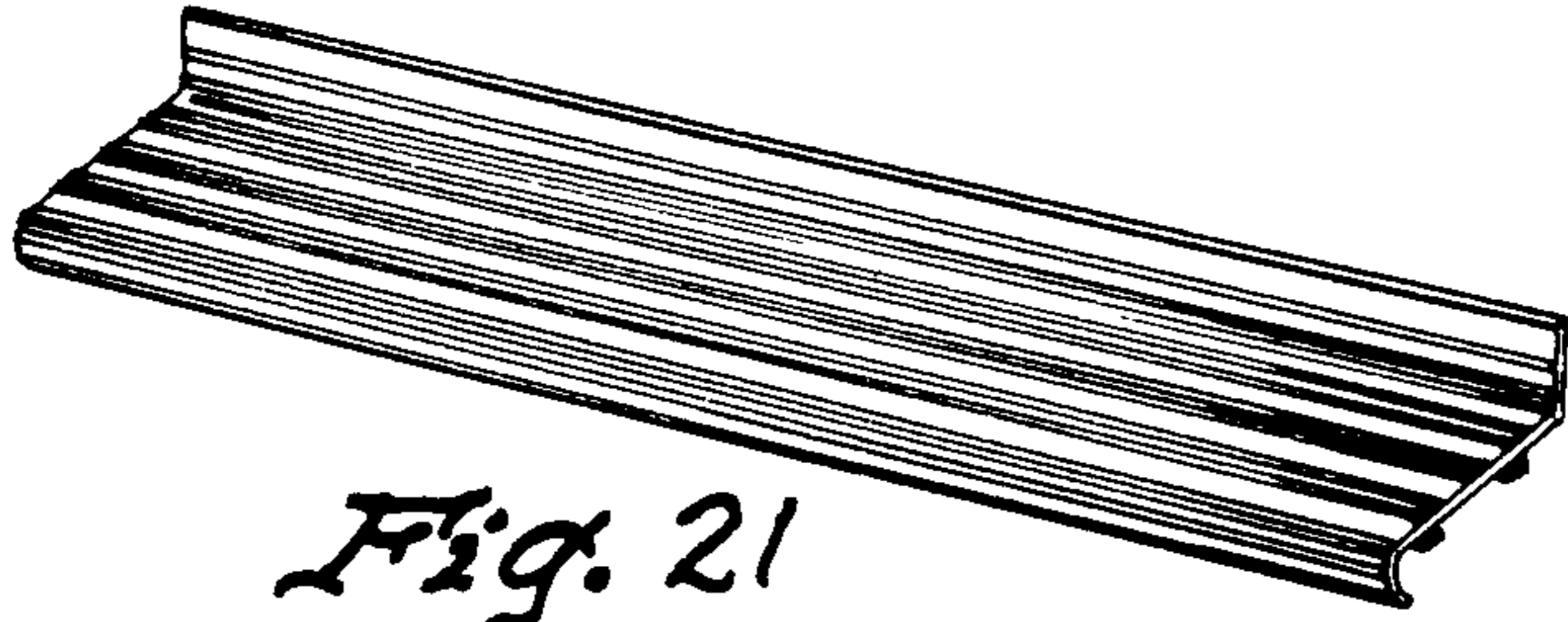

Fig. 21

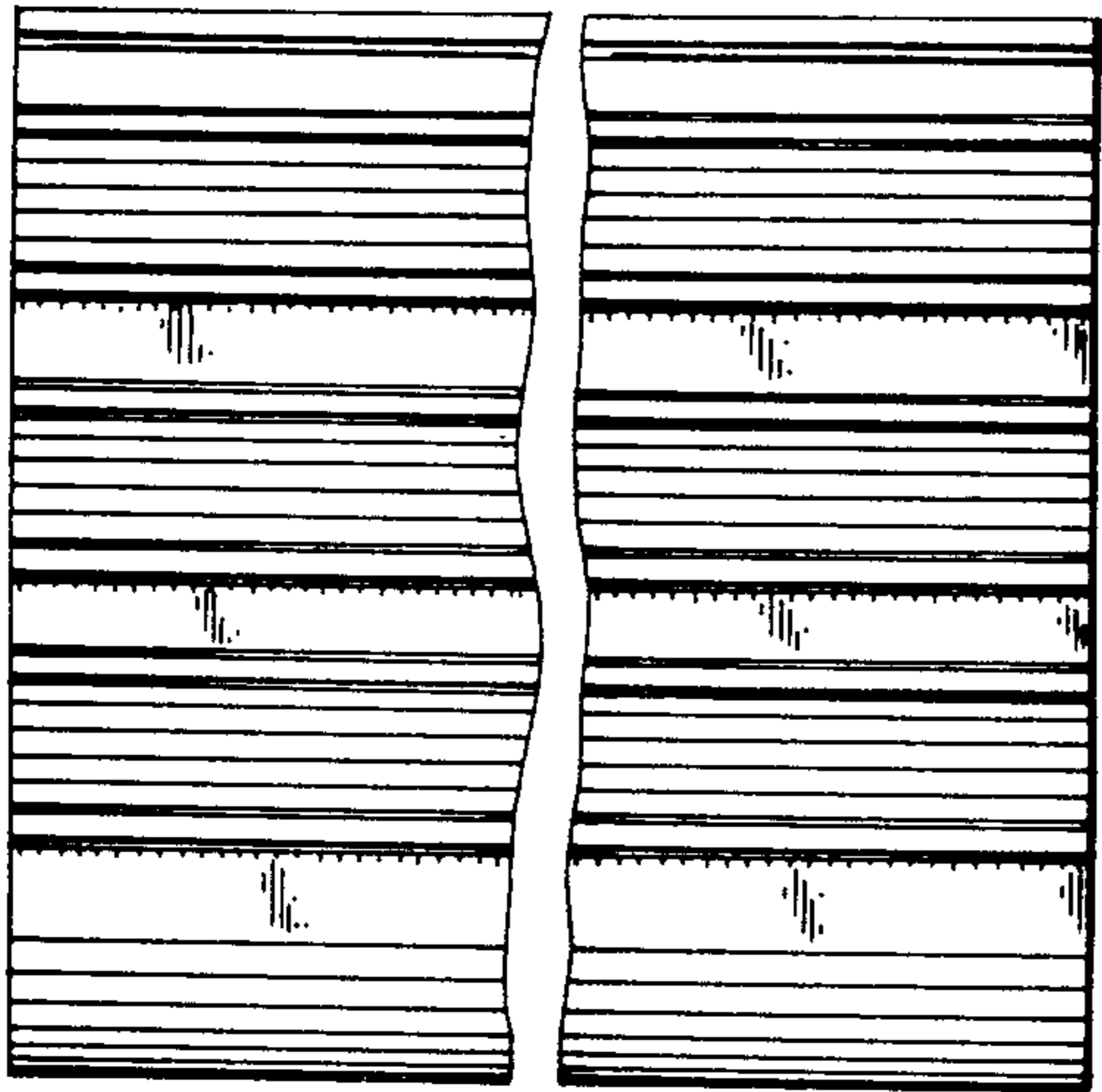

Fig. 22

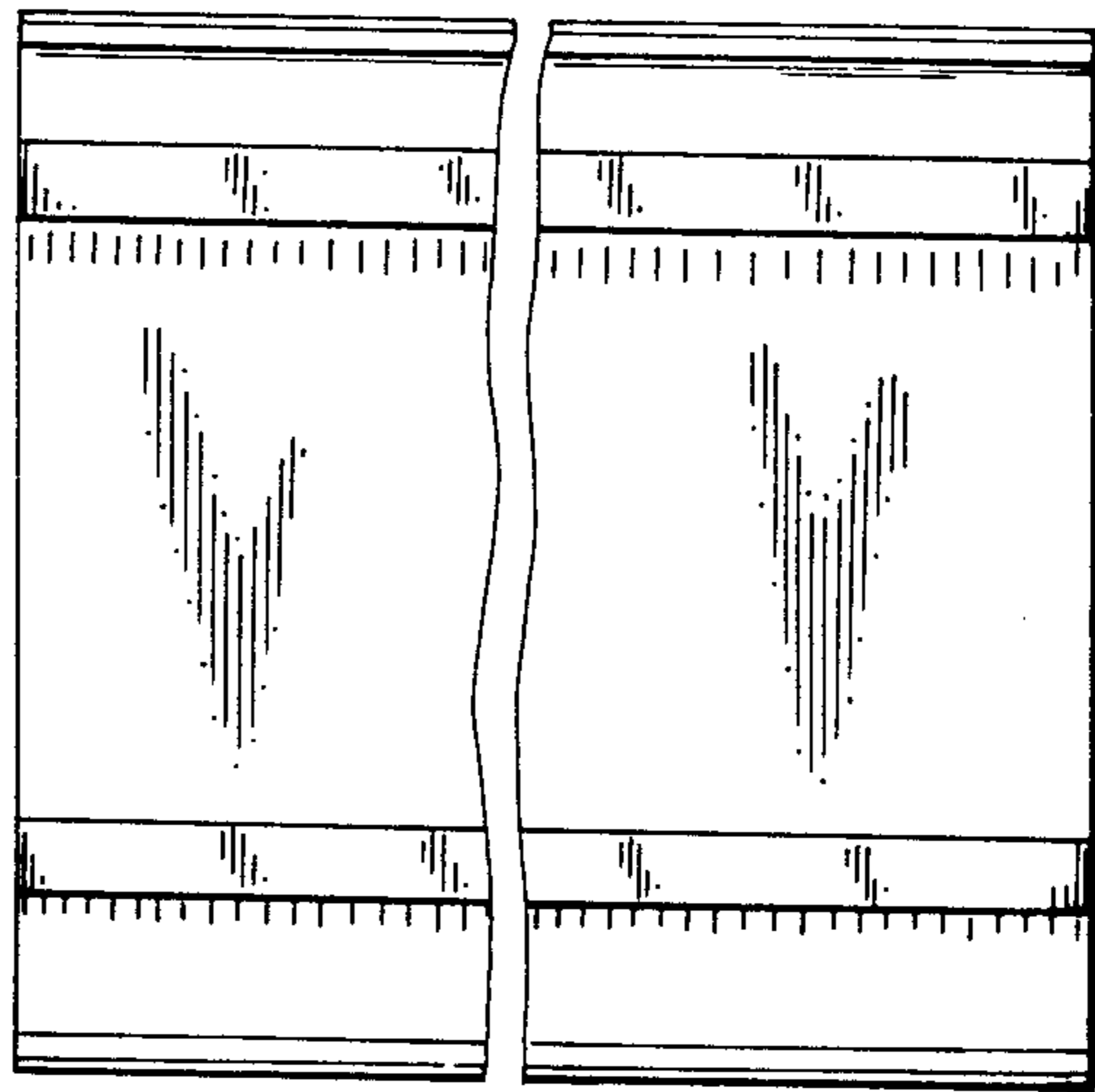

Fig. 23

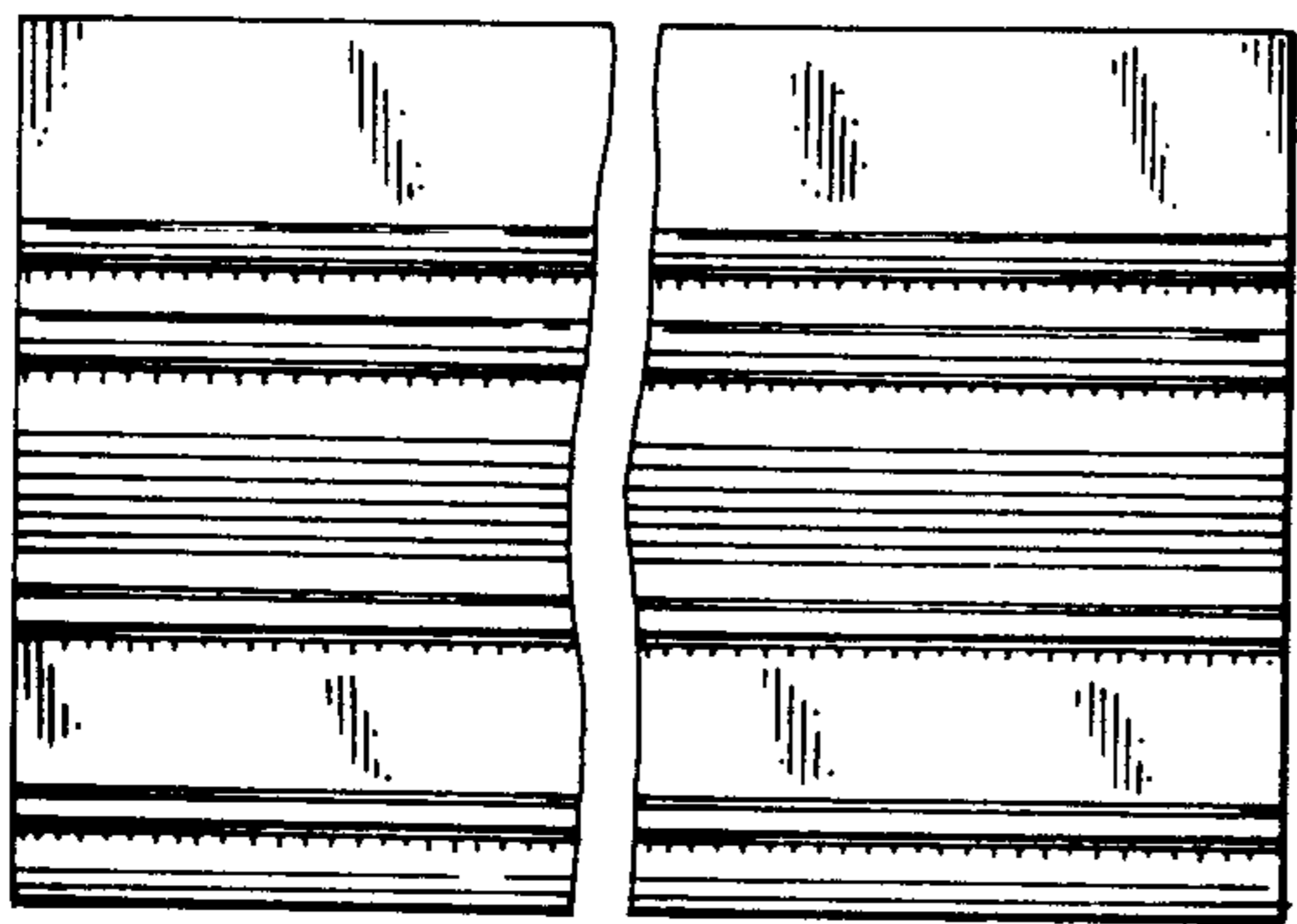

Fig. 24

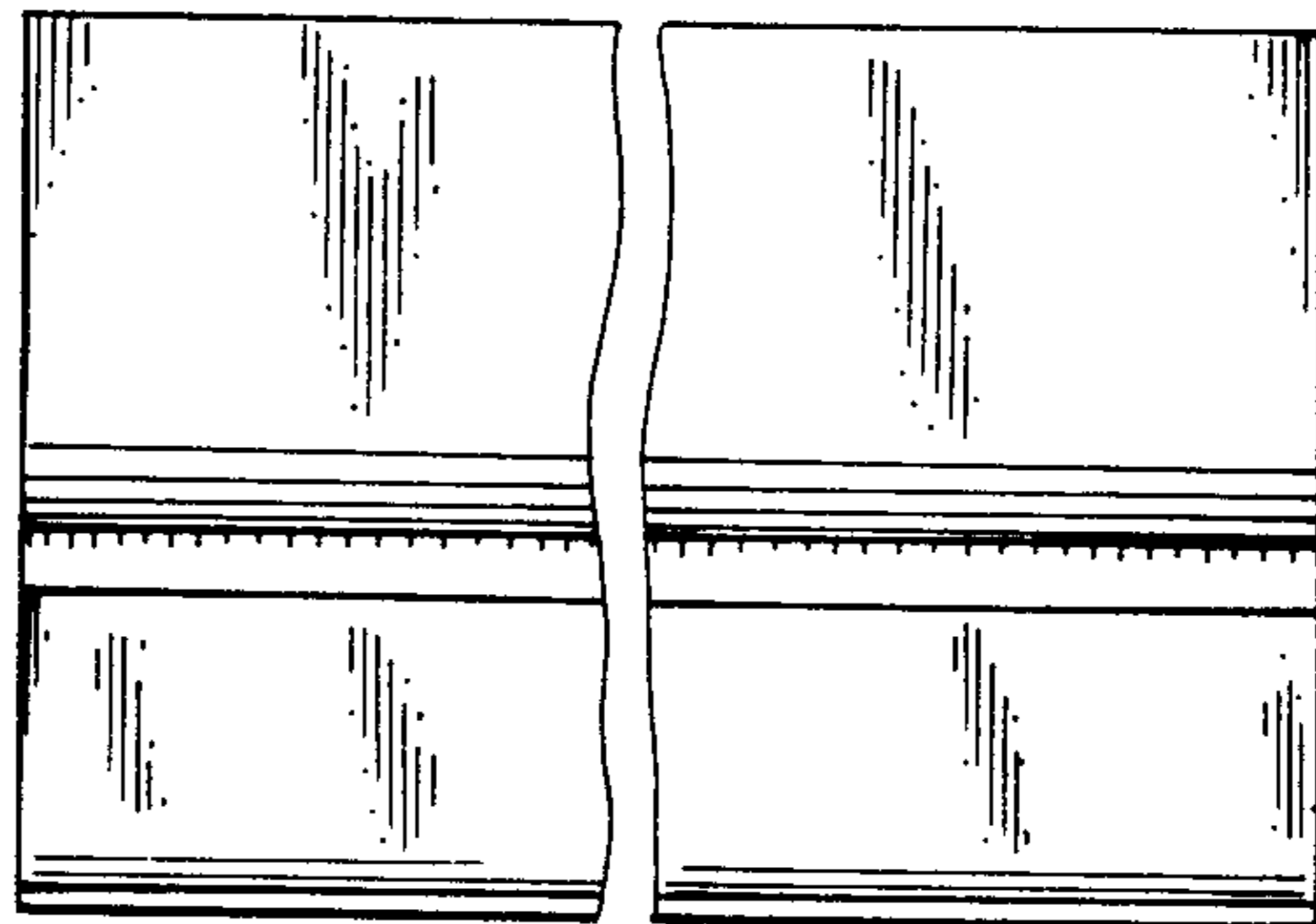

Fig. 25

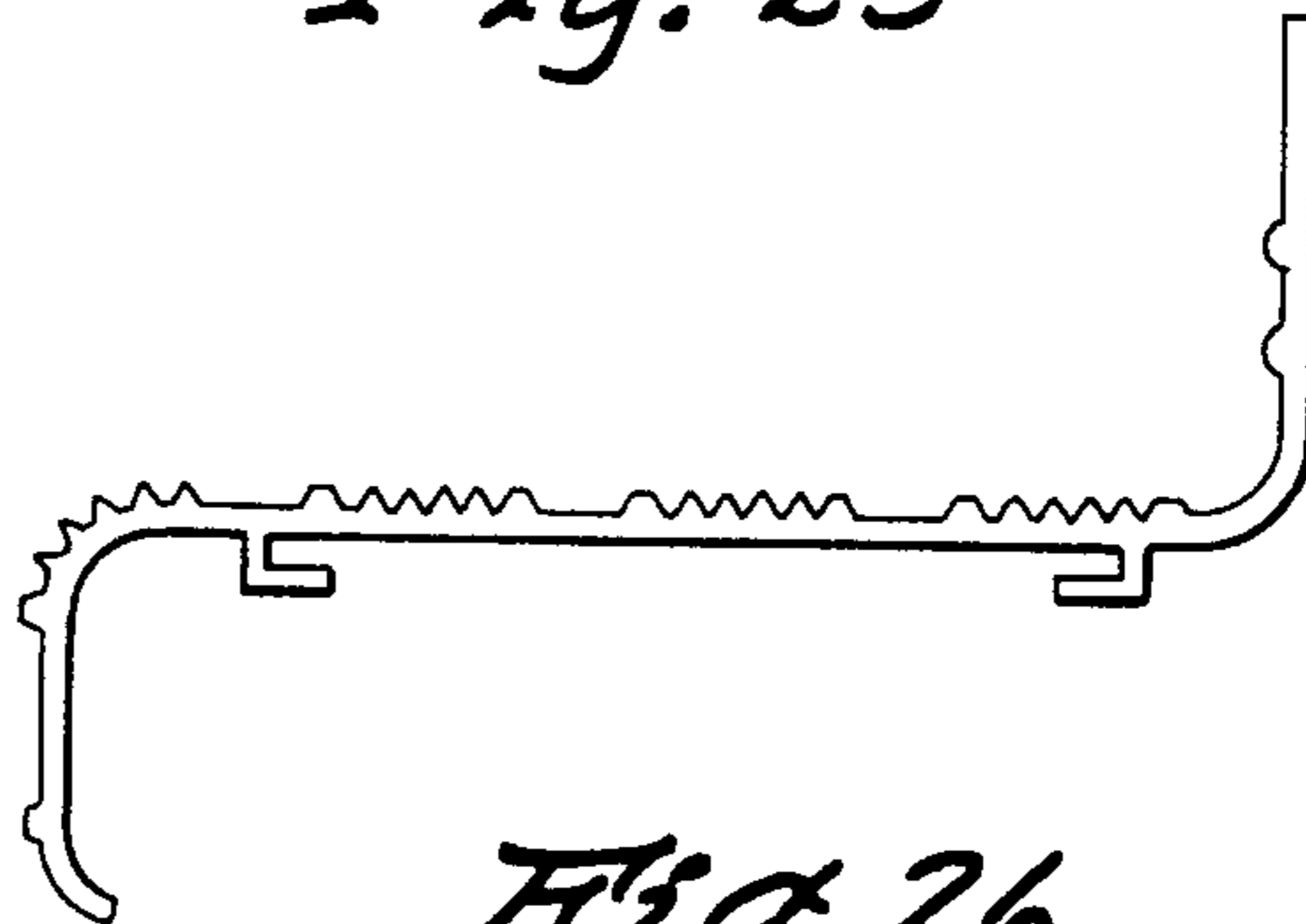

Fig. 26