

[54] **COMBINED CRAB MALLET SET AND SUPPORT STAND**

[76] Inventor: **Stephen J. Evan**, 6514 Midra Dr., Lanham, Md. 20801

[**] Term: **14 Years**

[21] Appl. No.: **938,489**

[22] Filed: **Aug. 31, 1978**

[51] Int. Cl. **D07-06**

[52] U.S. Cl. **D7/101; D7/98; D21/210**

[58] Field of Search **D7/98, 99, 101; 99/571; 17/75; D8/75, 77, 78; D21/210, 223; D6/188**

[56] **References Cited**

U.S. PATENT DOCUMENTS

D. 46,656	11/1914	Bamberger	D6/188
D. 231,890	6/1974	Kritkauskys	D7/106 X
3,017,186	1/1962	Ascardi	D21/210 X

FOREIGN PATENT DOCUMENTS

628712	10/1927	France	9/571
--------	---------	--------	-------	-------

OTHER PUBLICATIONS

Discovery House, Winter 1976 Cat., p. 26, Meat Tenderizer Aluminum Mallet #8350, bottom left.

Primary Examiner—Winifred E. Herrmann

[57] **CLAIM**

The ornamental design for a combined crab mallet set and support stand, as shown and described.

DESCRIPTION

FIG. 1 is a top perspective view of a combined crab mallet set and support stand showing my new design; FIG. 2 is a side elevational view thereof, shown partially in cross-section, both sides being identical;

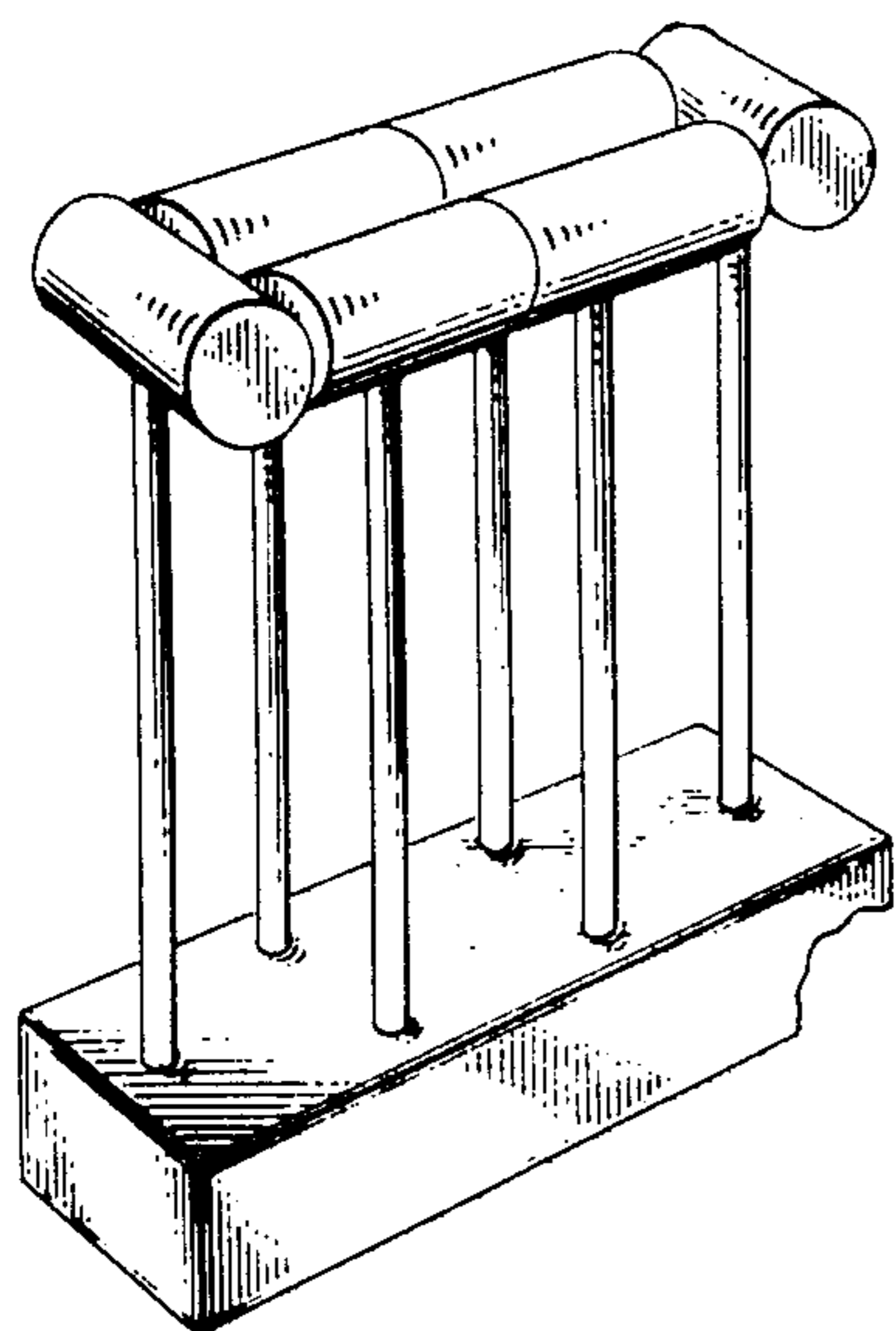

FIG. 3 is an end elevational view thereof, both ends being identical;

FIG. 4 is a top plan view thereof;

FIG. 5 is a reduced scale side elevational view of the same basic mallet set shown in FIGS. 1-4, but showing a ninth mallet in association therewith, the ninth mallet laying on the stand base between spaced rows of the mallets;

FIG. 6 is a left end elevational view on the same reduced scale as FIG. 5 and of the nine mallet set shown therein;

FIG. 7 is a right end elevational view of the same set depicted in FIGS. 5 and 6;

FIG. 8 is a bottom plan view of the sets shown in FIGS. 1-7 and FIGS. 9-11, respectively;

FIG. 9 is a side elevational view of a slightly modified ten mallet set, being essentially the same basic set of FIG. 1, but with the ninth and tenth mallets laying on the stand base between spaced rows of the mallets as shown;

FIG. 10 is an end elevational view of the slightly modified set of mallets shown in FIG. 9, and of which opposite end views are essentially identical;

FIG. 11 is another perspective view of a still further slightly modified stand-mounted set of six crab mallets, which except for the total number of mallets is otherwise essentially identical to the set shown in FIG. 1;

FIG. 12 is a side elevational view of the set shown in FIG. 11;

FIG. 13 is a similar side elevational view of the basic set shown in FIGS. 11 and 12, but showing a seventh mallet in conjunction therewith between the spaced longitudinal rows of mallets;

FIG. 14 is a left end elevational view of the set shown in FIG. 13;

FIG. 15 is still a further perspective view similar to FIG. 11, but showing two diagonally crossed mallets between longitudinal spaced rows of the same basic set of six mallets depicted in FIG. 11 and 12; and

FIG. 16 is a side elevational view of the modified set of eight mallets and stand shown in FIG. 15.

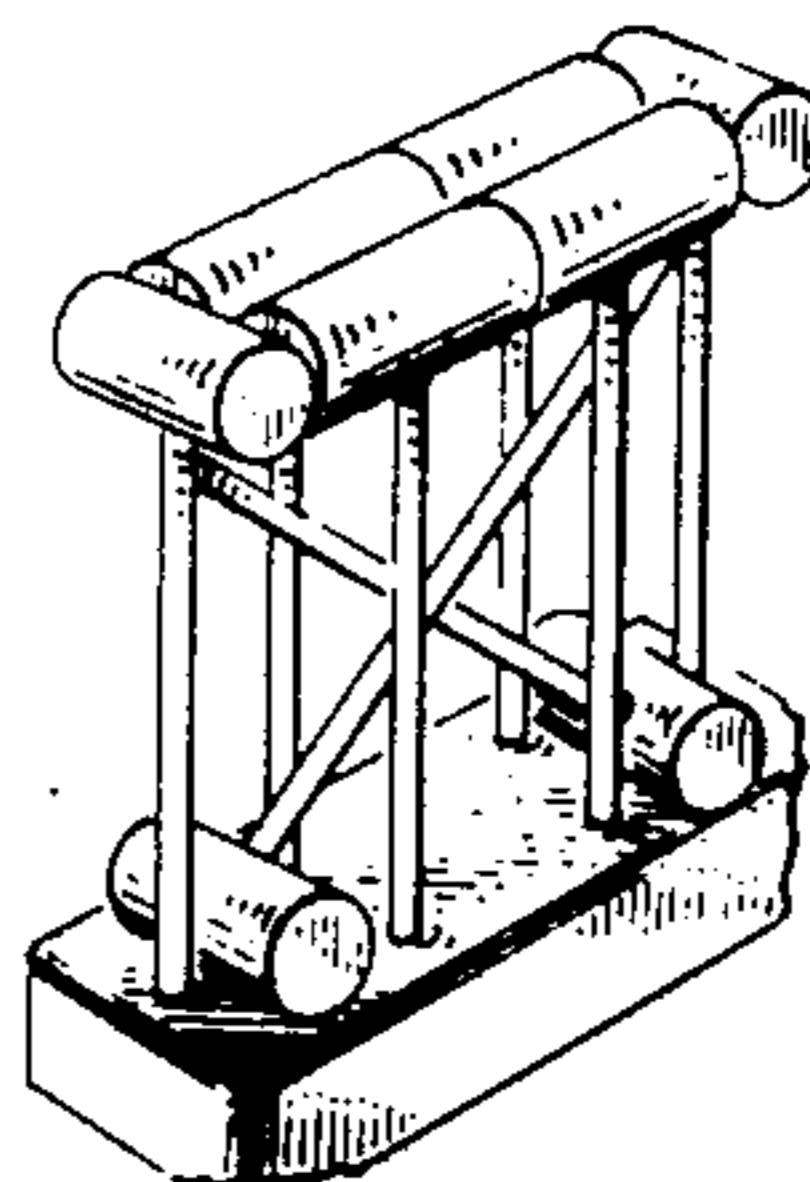

FIG. 1.

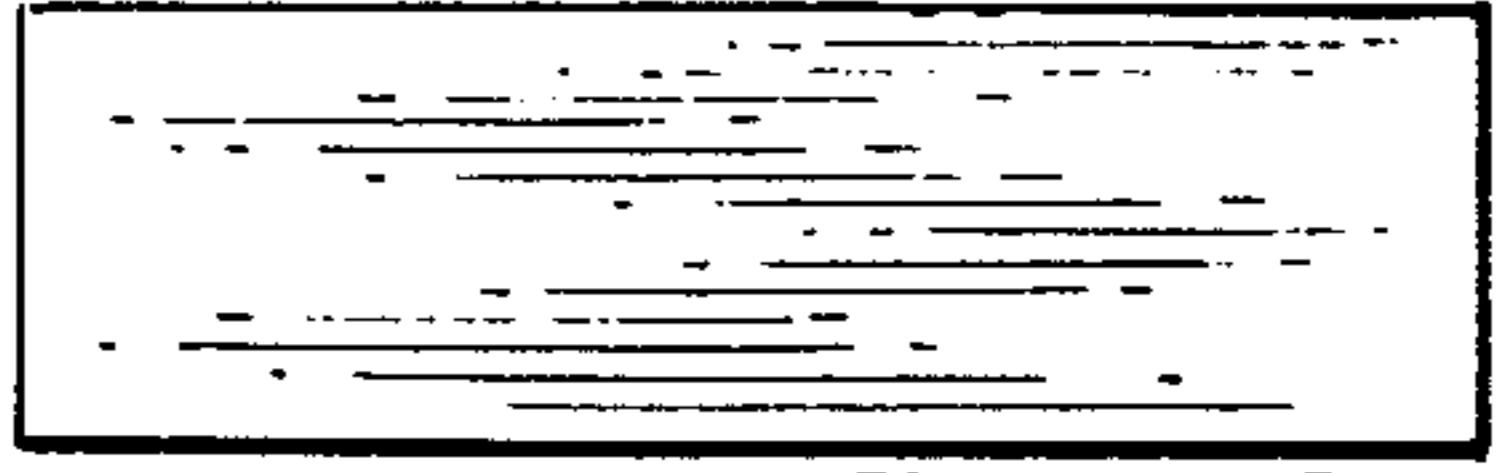
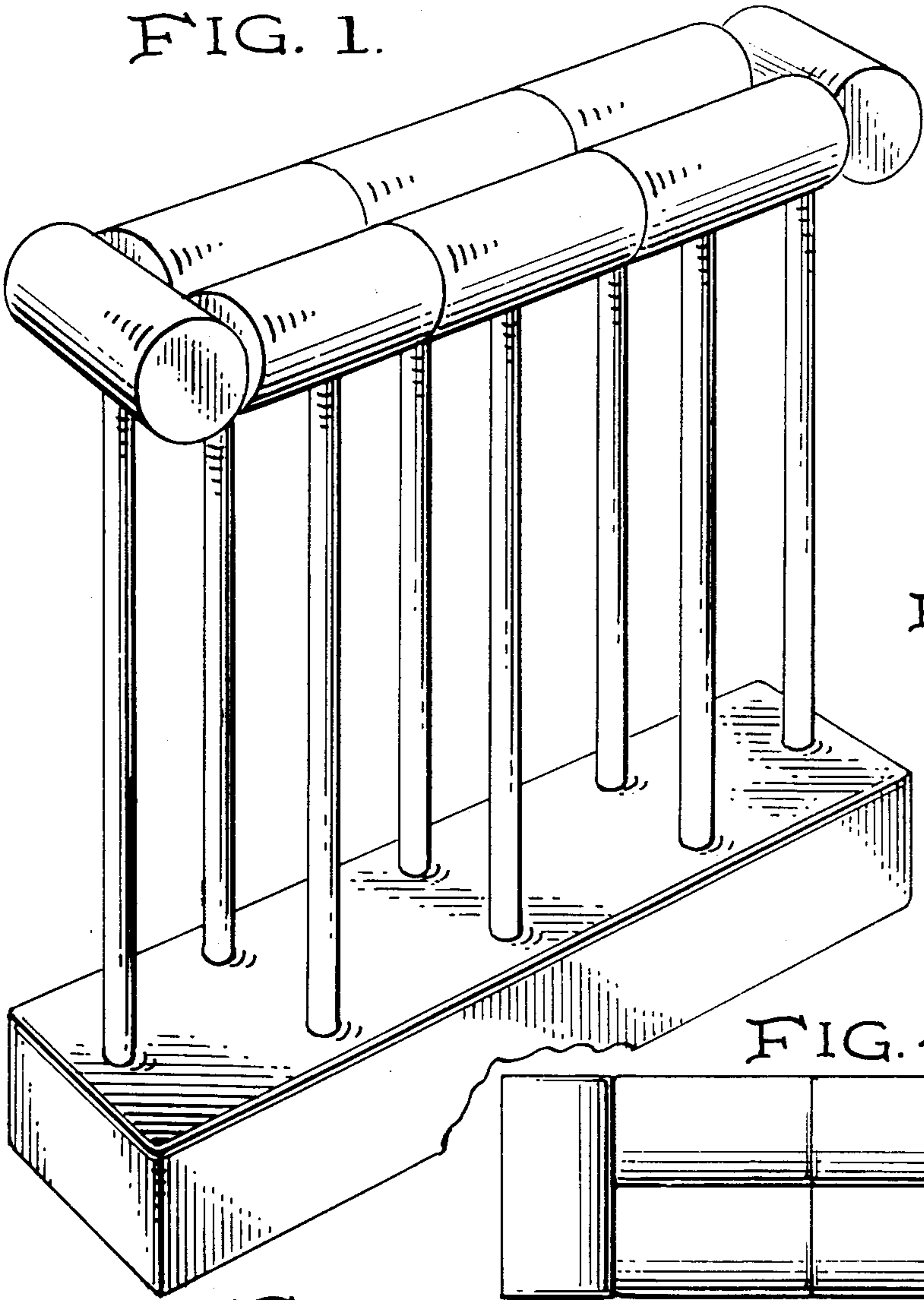

FIG. 8.

FIG. 5.

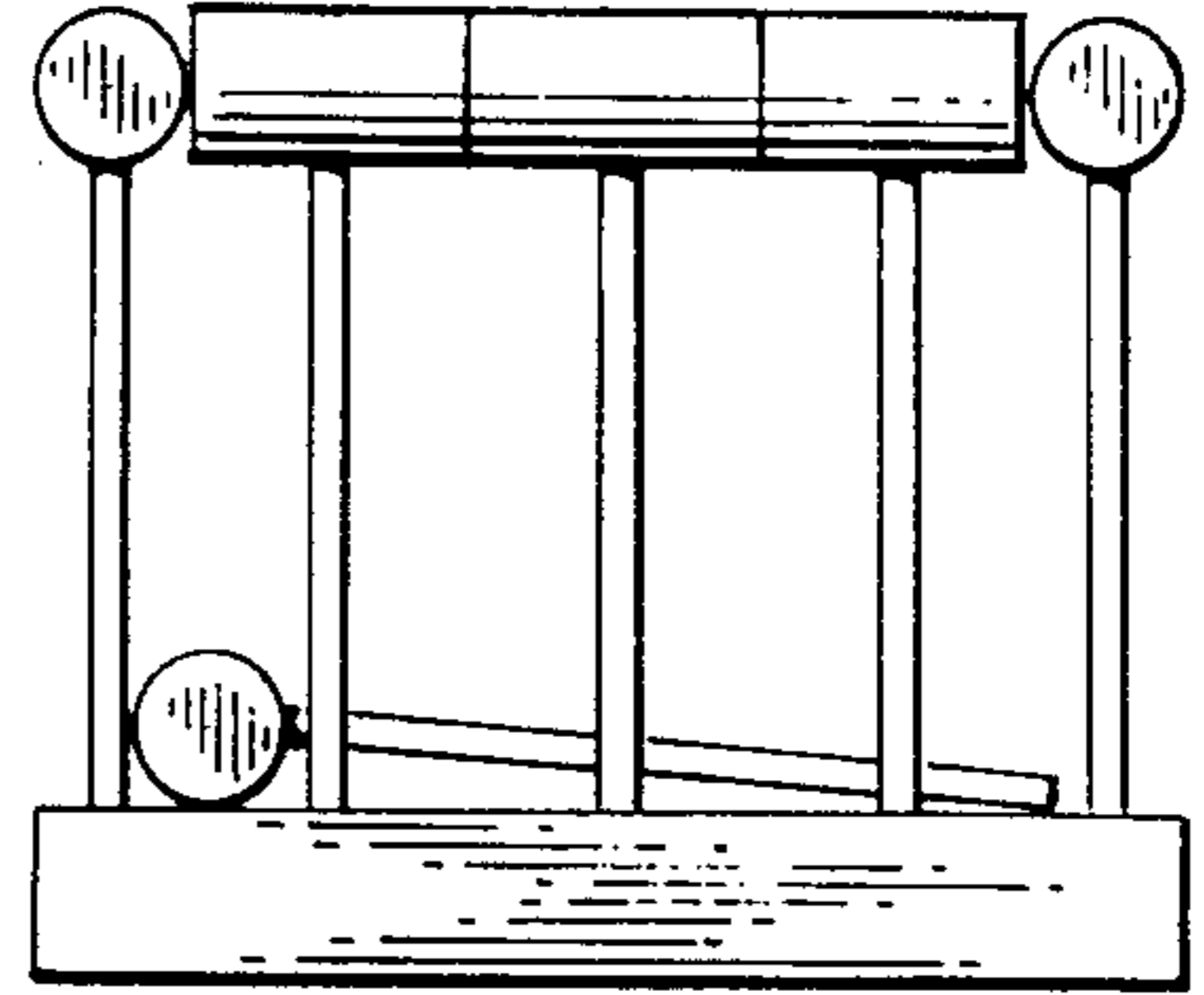

FIG. 6.

FIG. 7.

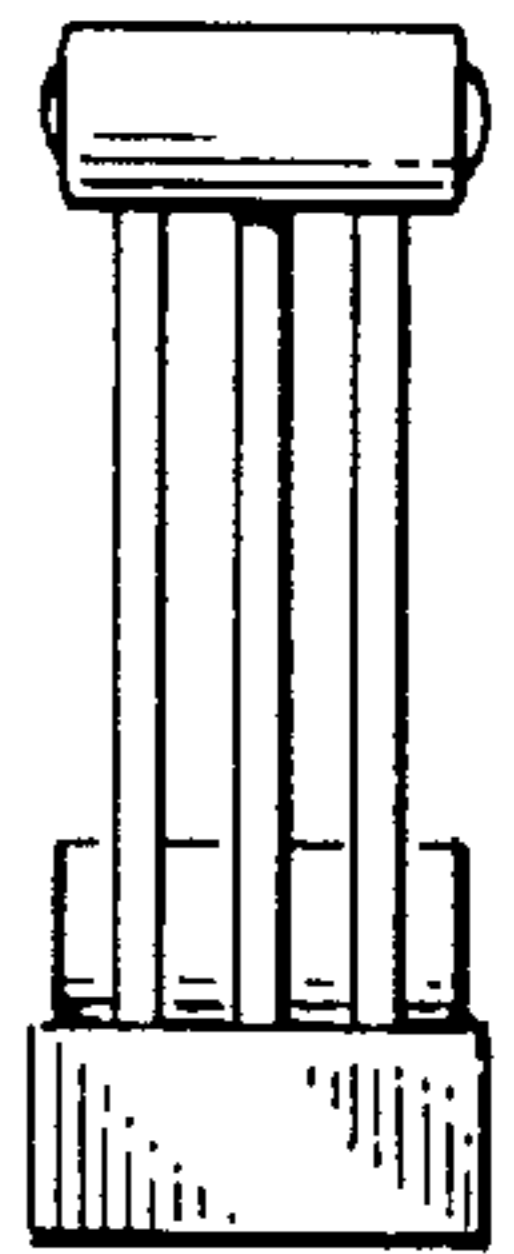
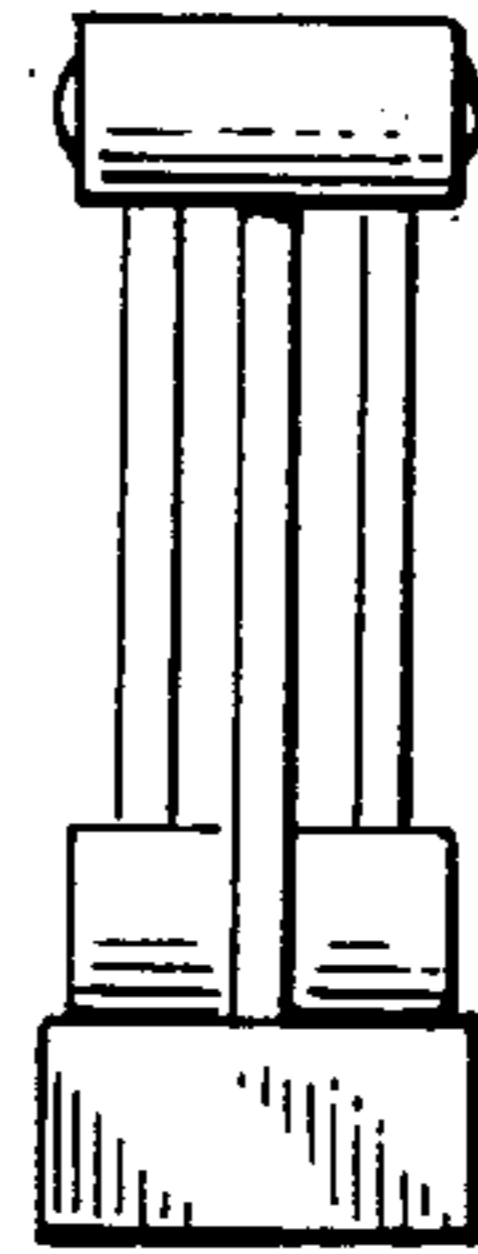

FIG. 4.

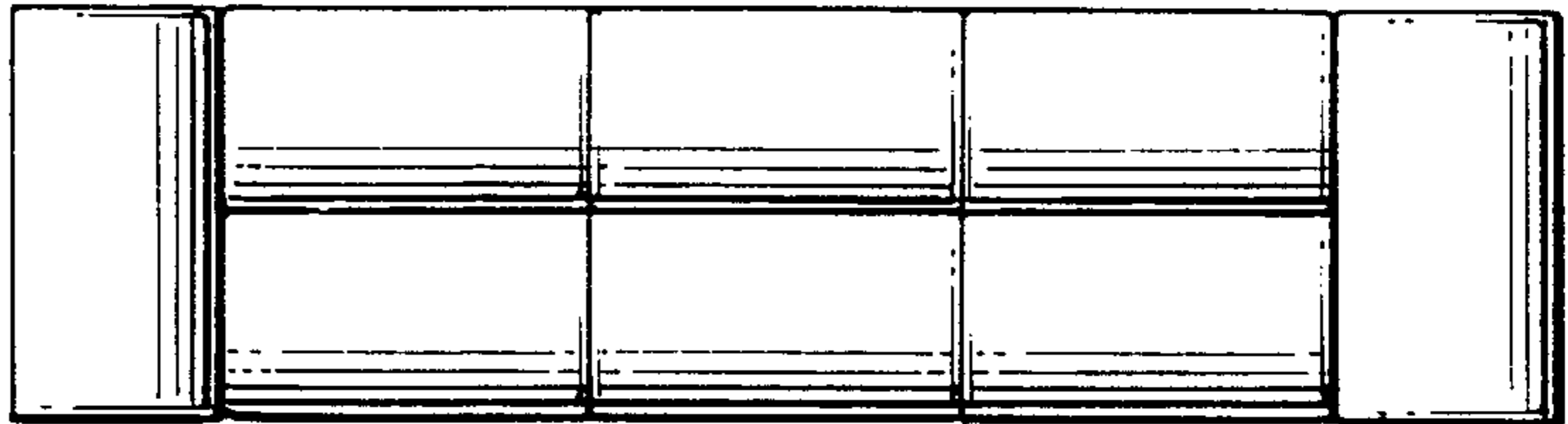

FIG. 2.

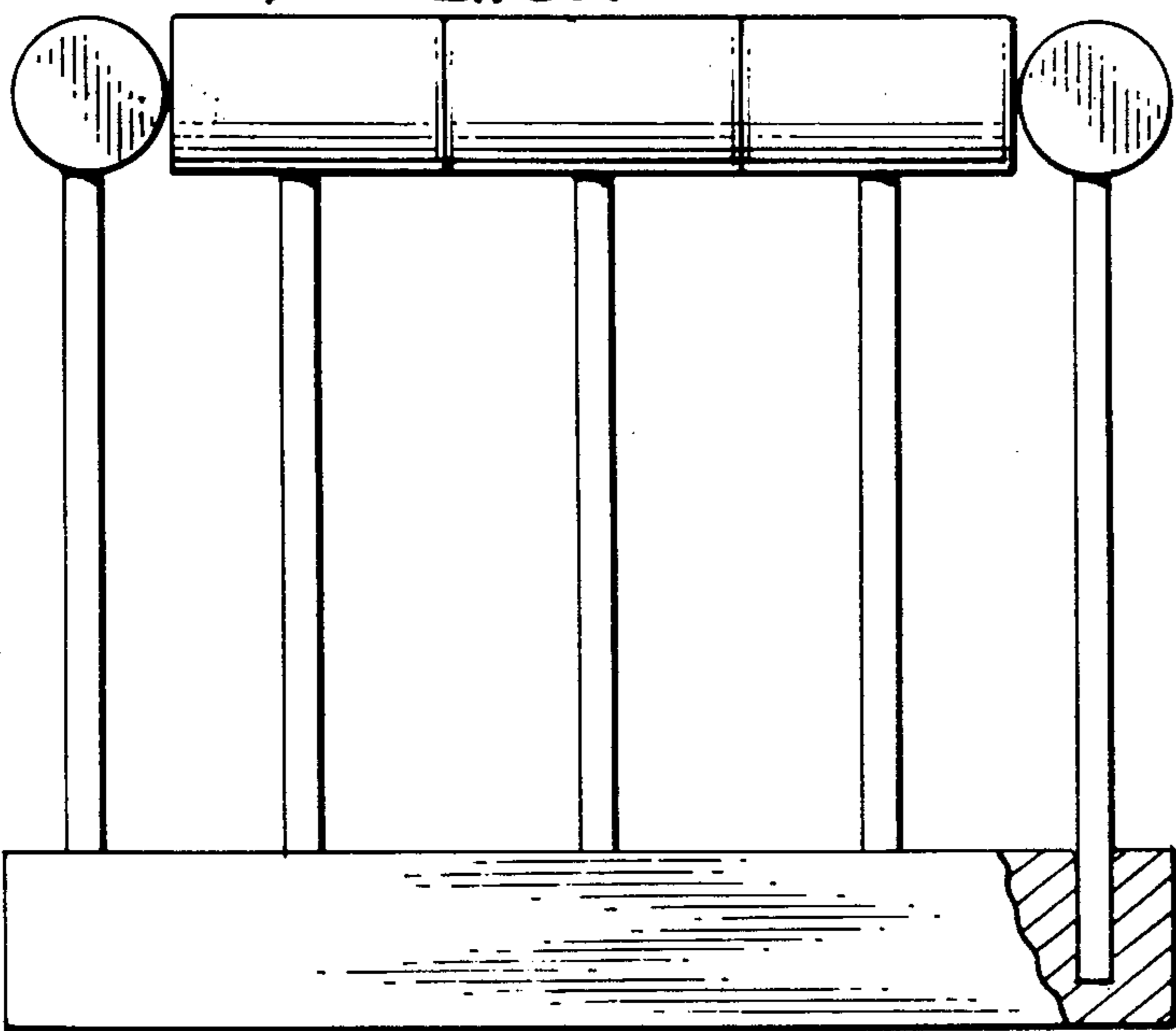

FIG. 3.

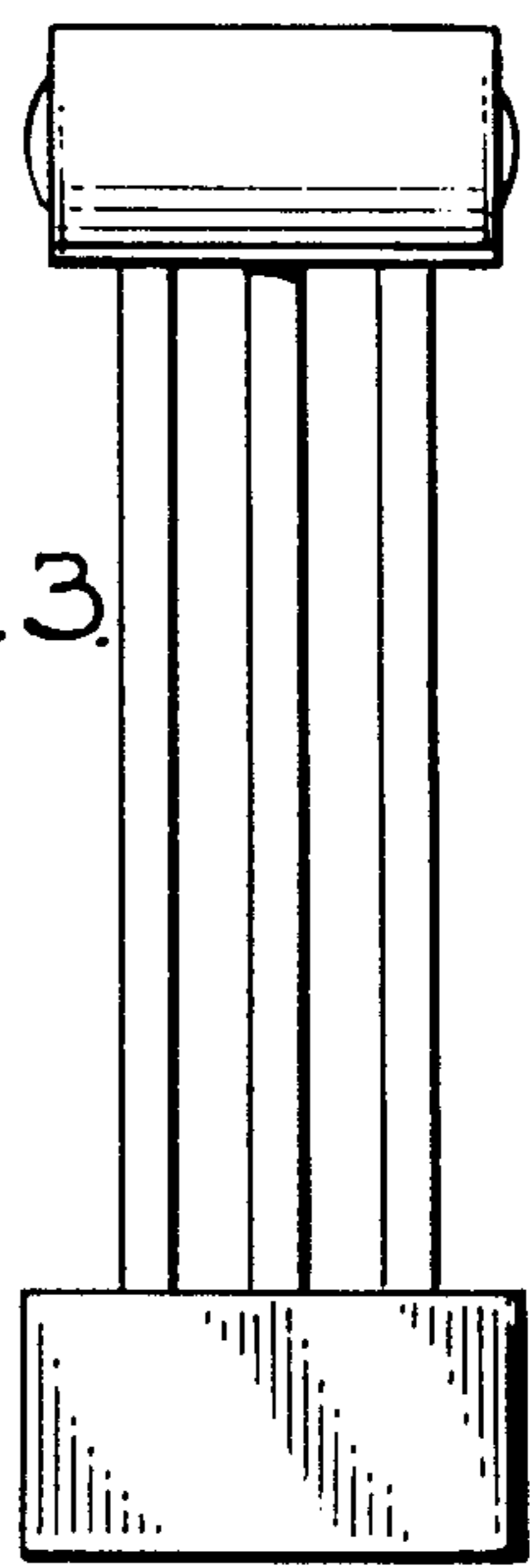

FIG. 11.

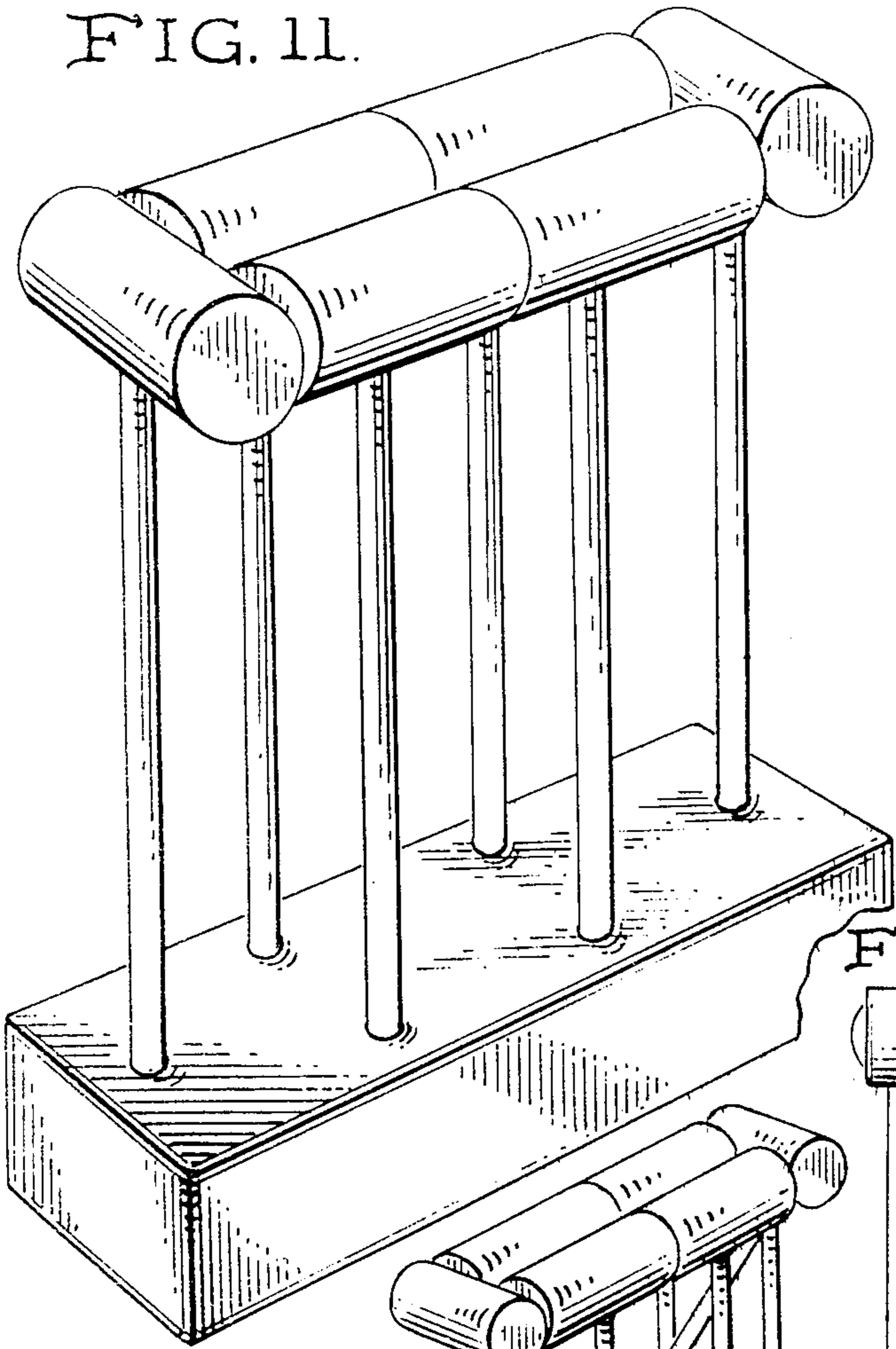

FIG. 12.

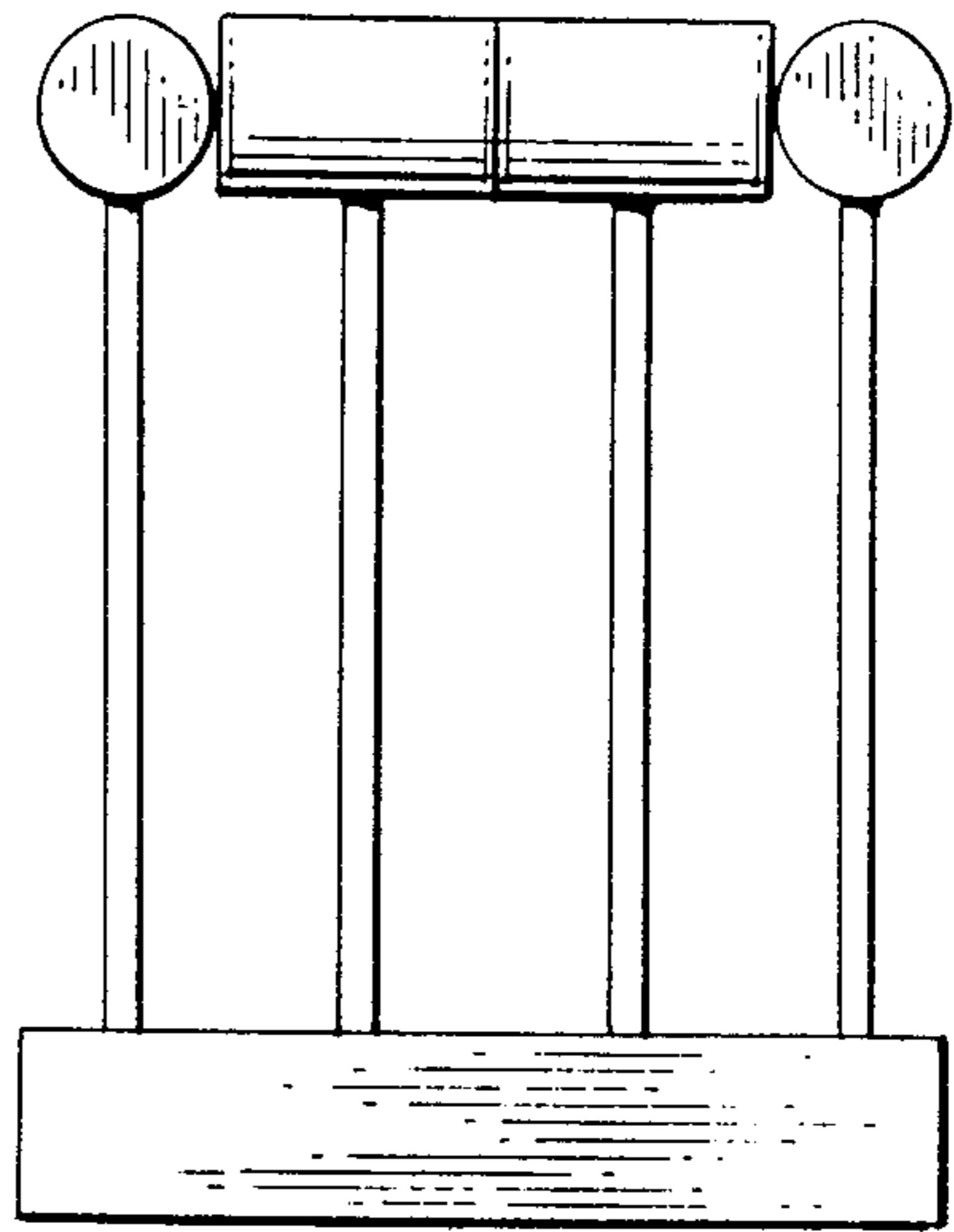

FIG. 15.

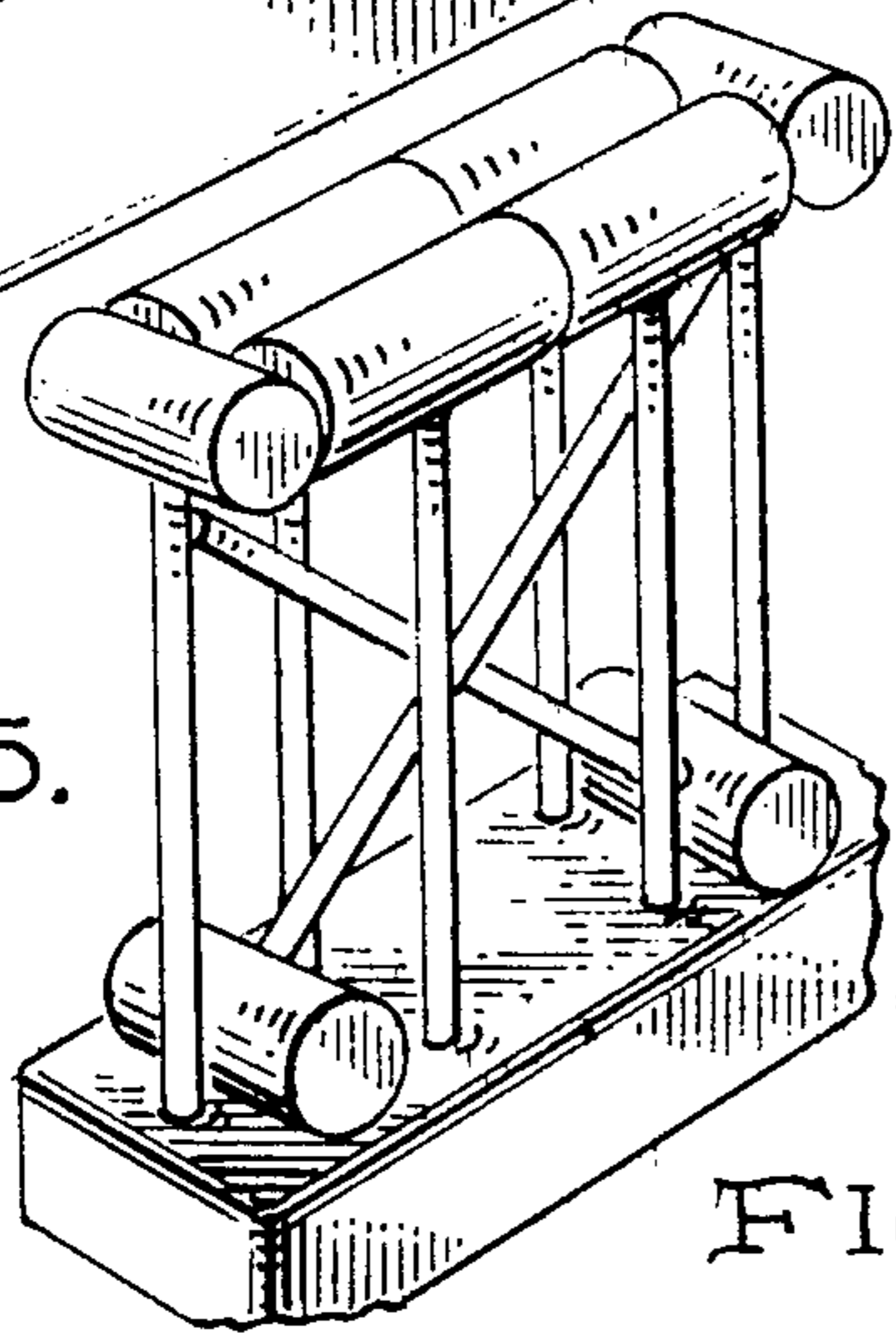

FIG. 14.

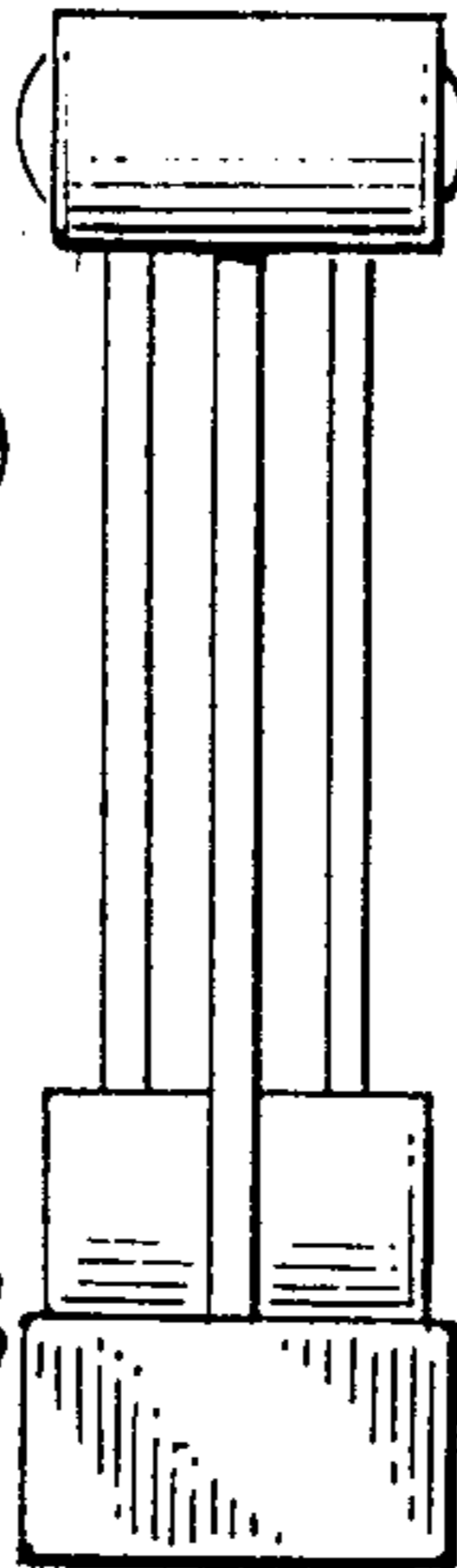

FIG. 13.

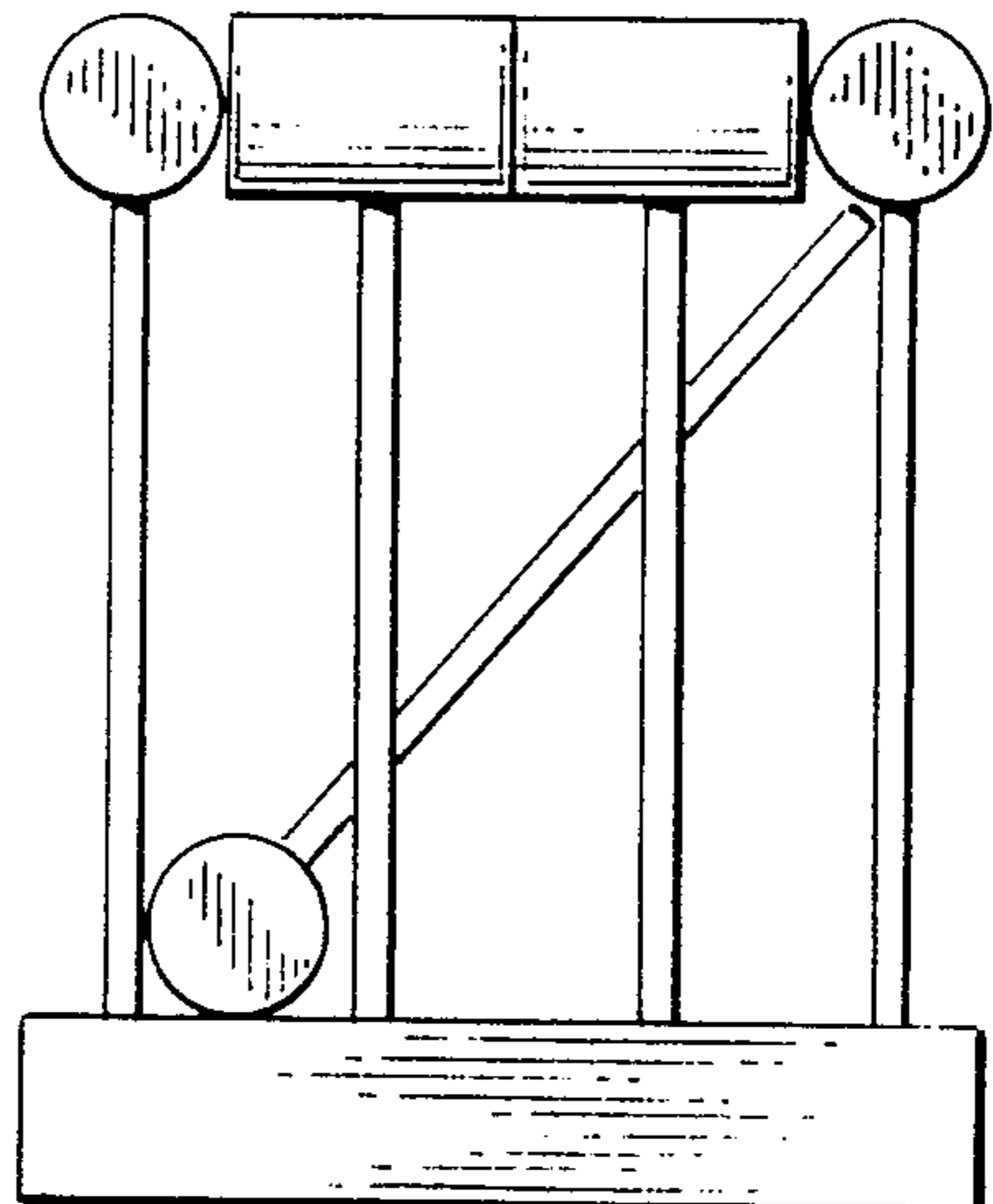

FIG. 9.

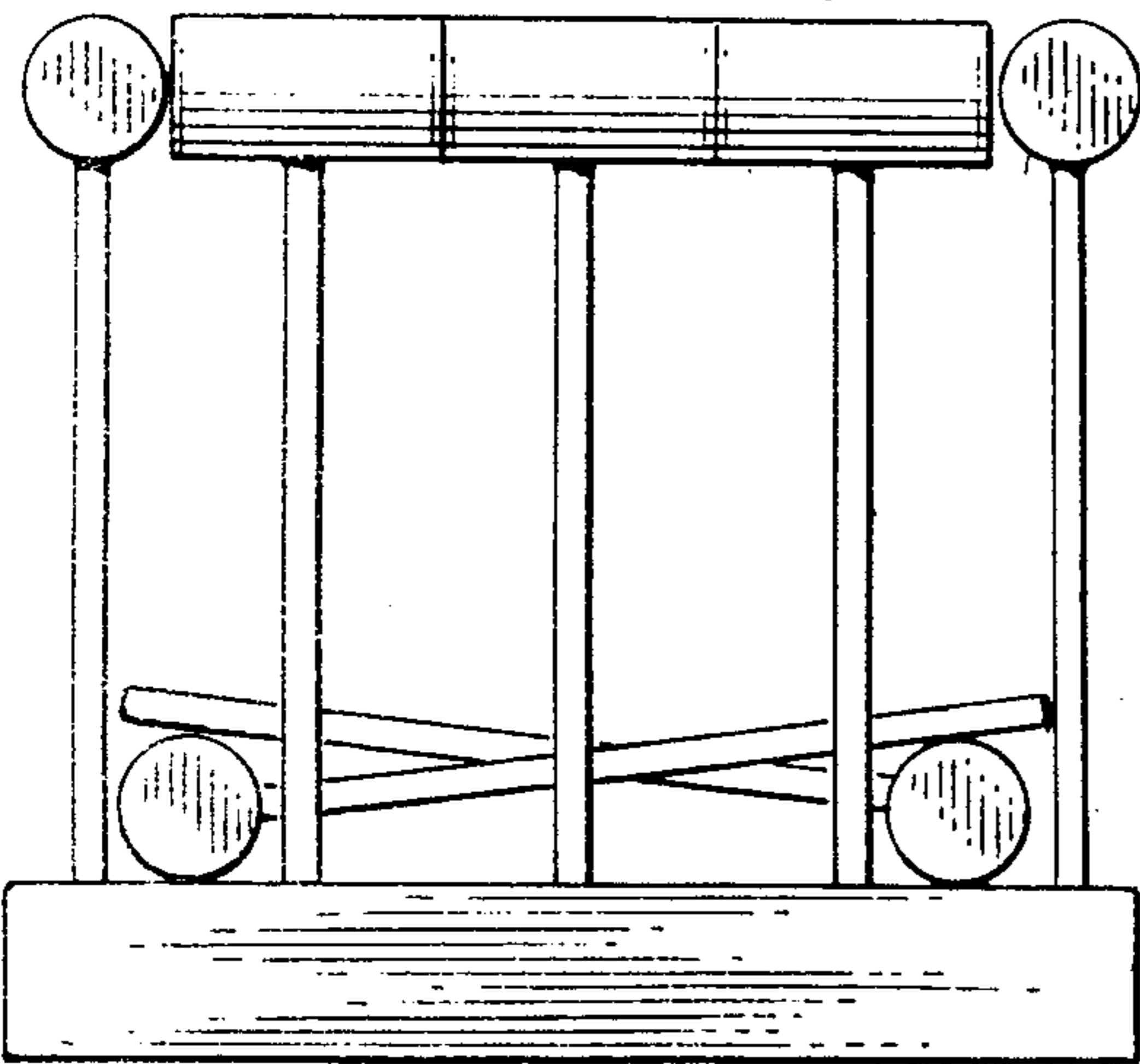

FIG. 10.

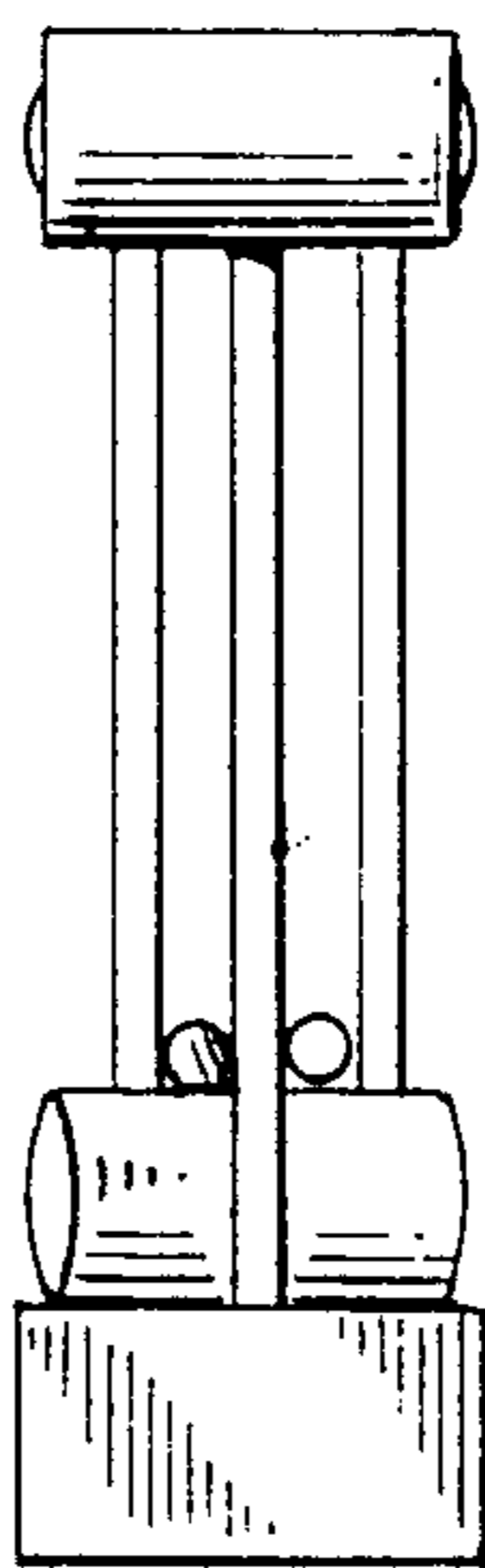

FIG. 16.

