

[54] BOTTLE CAP

[76] Inventor: Jean Leger, 27 rue de Seine, Paris, France, 75006

[**] Term: 14 Years

[21] Appl. No.: 891,482

[22] Filed: Mar. 29, 1978

[51] Int. Cl. D09-99

[52] U.S. Cl. D9/283

[58] Field of Search D9/254, 262, 10, 275, D9/273; D28/87, 88; D4/26, 24; 132/1 R; 35/59; 215/228, 329; 401/6, 128, 128, 131, 139; D19/66, 70; 220/352

[56] References Cited

U.S. PATENT DOCUMENTS

D. 156,019 11/1949 Lynch D9/273

OTHER PUBLICATIONS

Drug & Cosmetic Industry, Dec. 1977, p. 74, Nail Polish Cap on top right of page.

Primary Examiner—Joel Stearman
Assistant Examiner—Carmen H. Vales
Attorney, Agent, or Firm—Milton J. Wayne

[57] CLAIM

The ornamental design for a bottle cap, substantially as shown and described.

DESCRIPTION

FIG. 1 is a perspective view of a bottle cap, showing my new design;
FIG. 2 is a front elevation view thereof;
FIG. 3 is a rear elevation view thereof;
FIG. 4 is a left side elevation view thereof;
FIG. 5 is a right side elevation view thereof;
FIG. 6 is a top plan view thereof;
FIG. 7 is a bottom plan view thereof;
FIG. 8 is a cross sectional view taken along the cutting plane 8-8 of FIG. 6; and
FIG. 9 is a cross sectional view taken along the cutting plane 9-9 of FIG. 6.

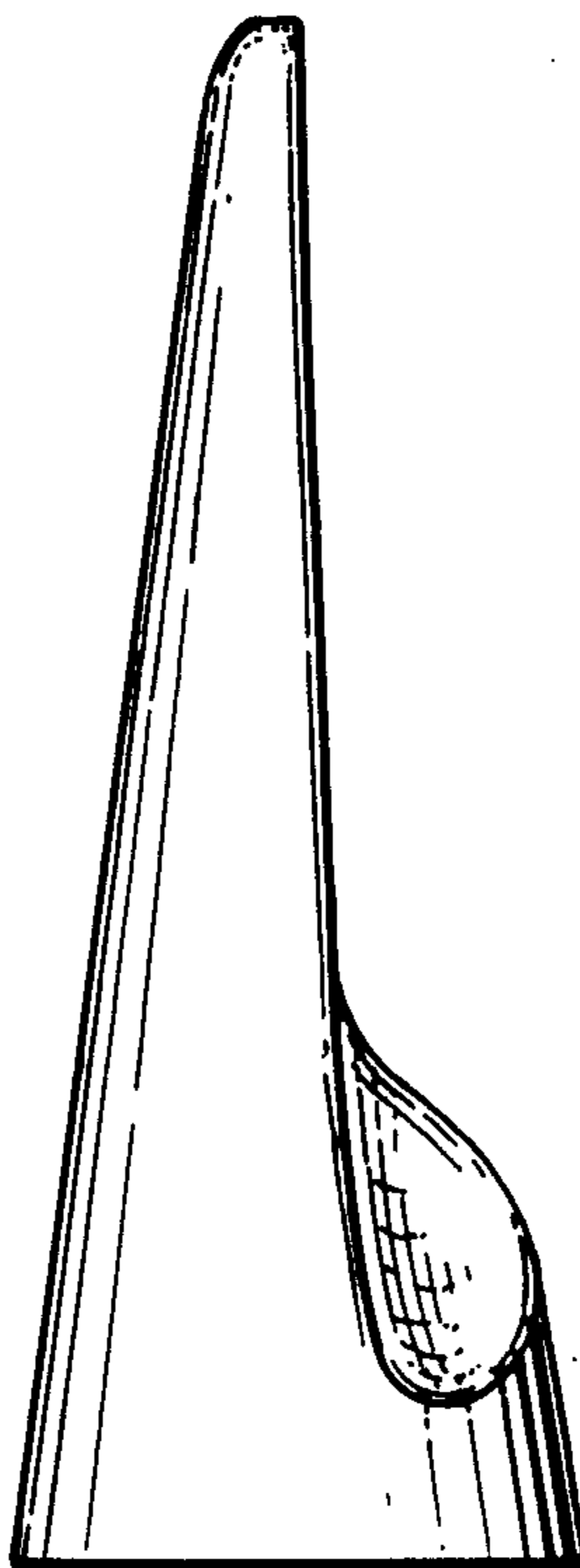
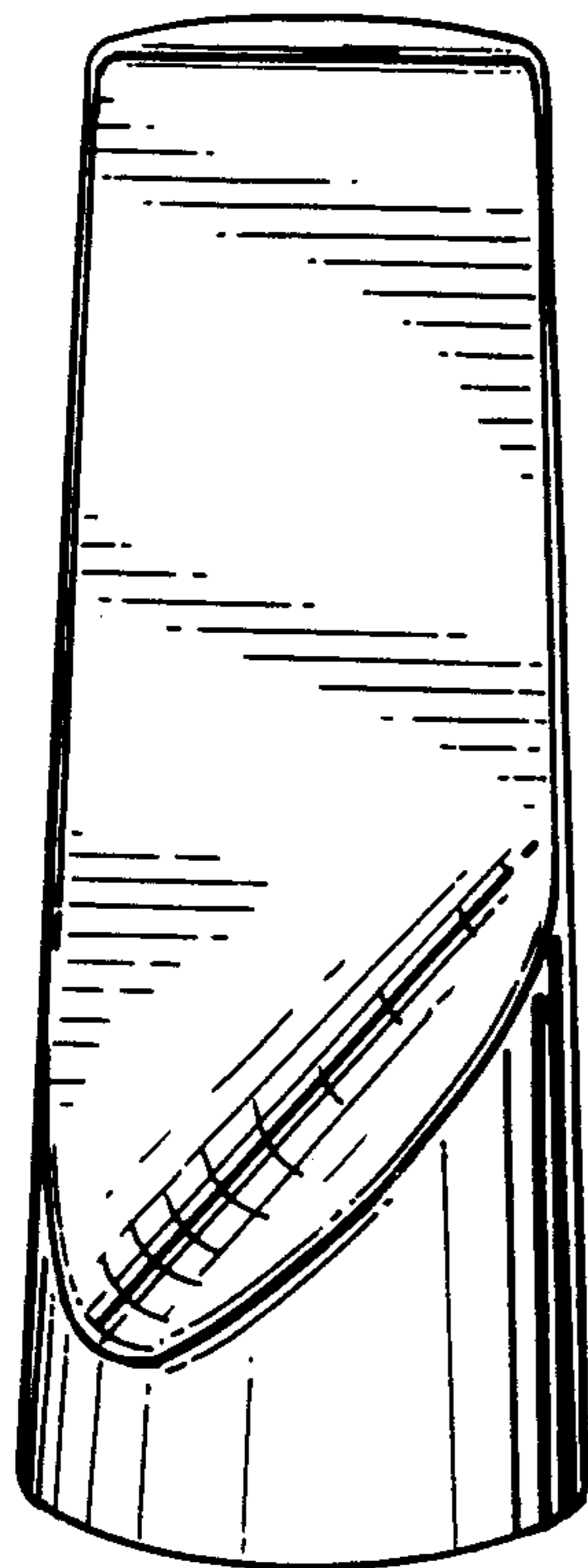

FIG. 1

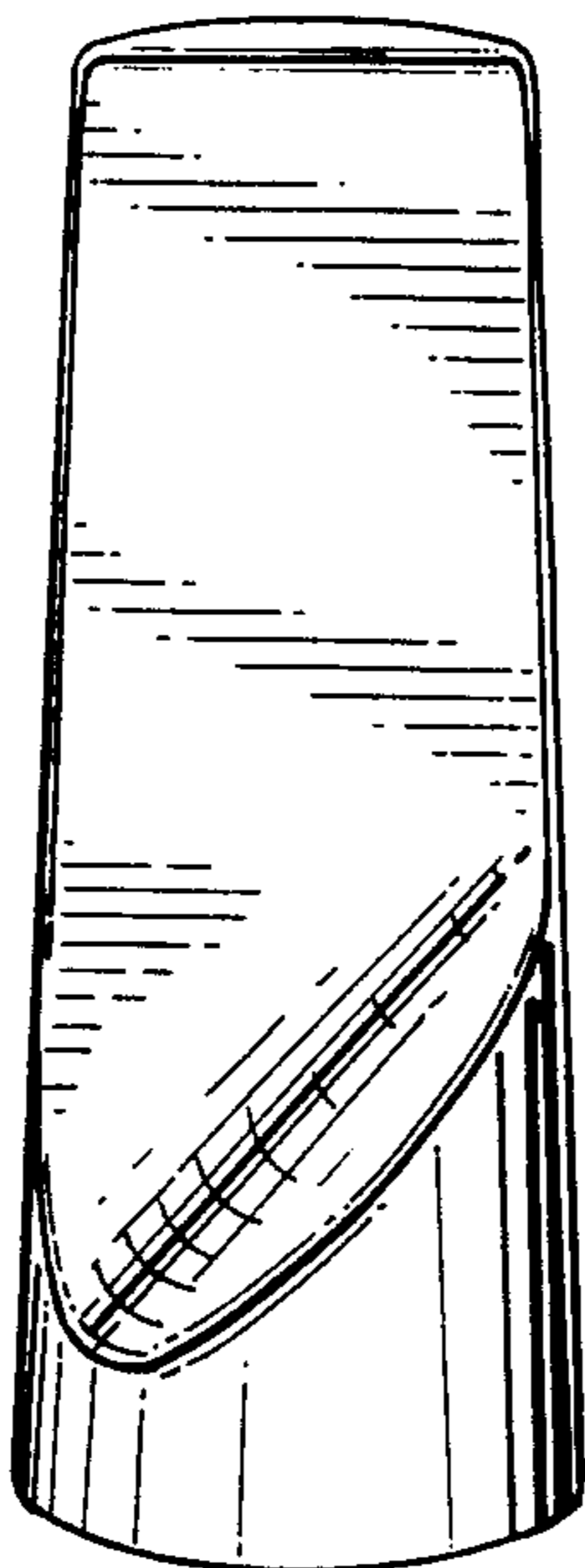

FIG. 2

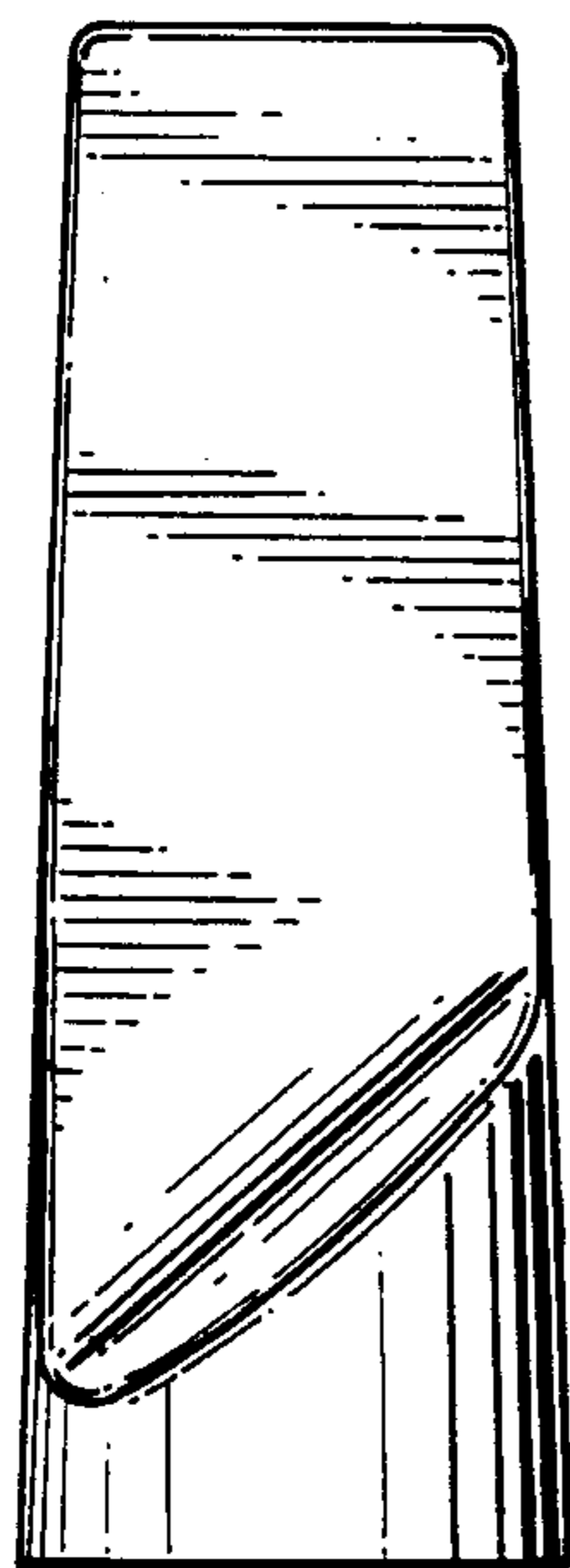
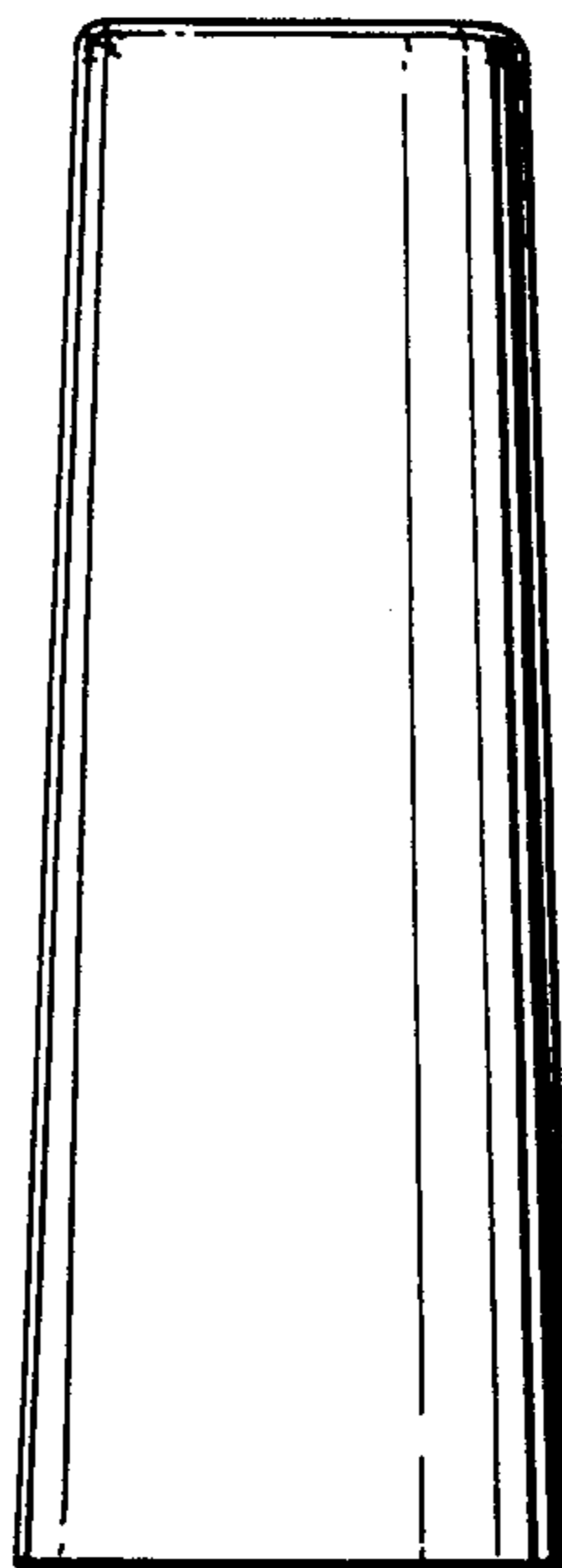
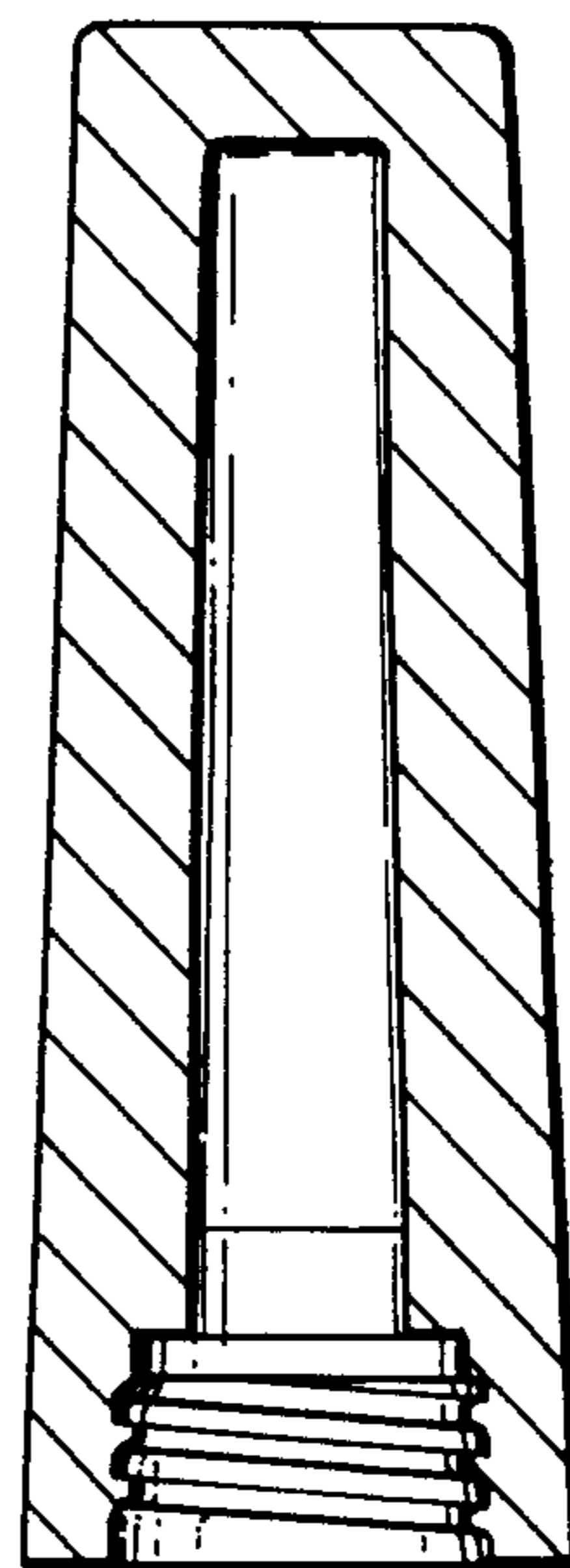
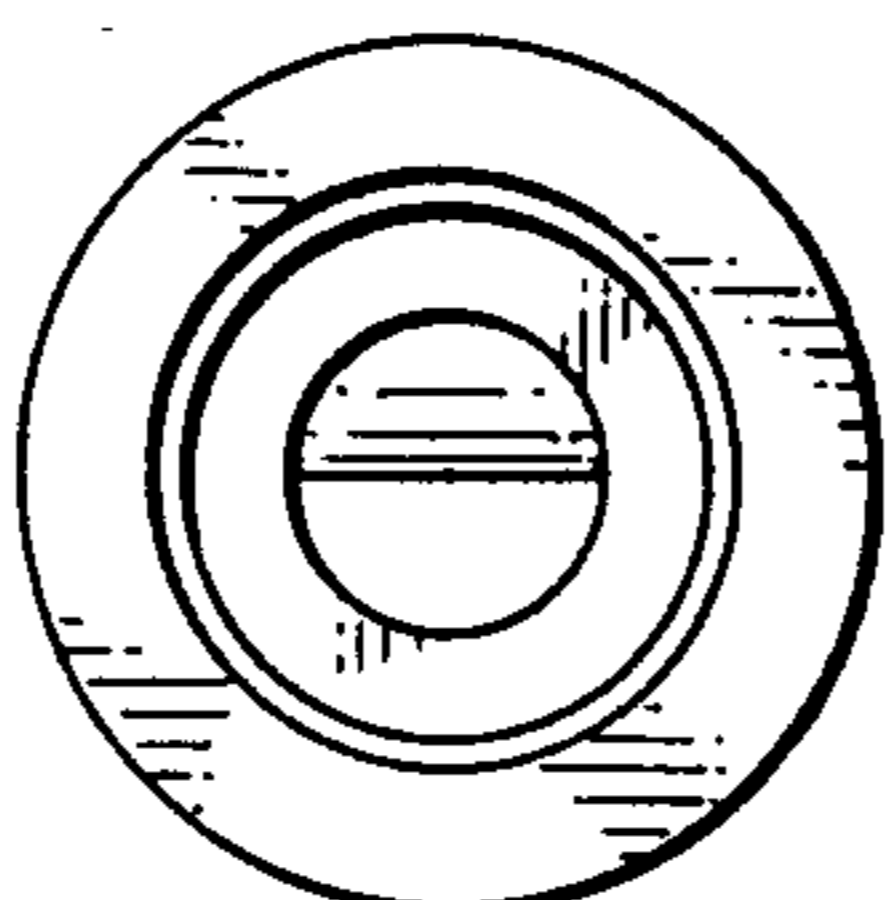
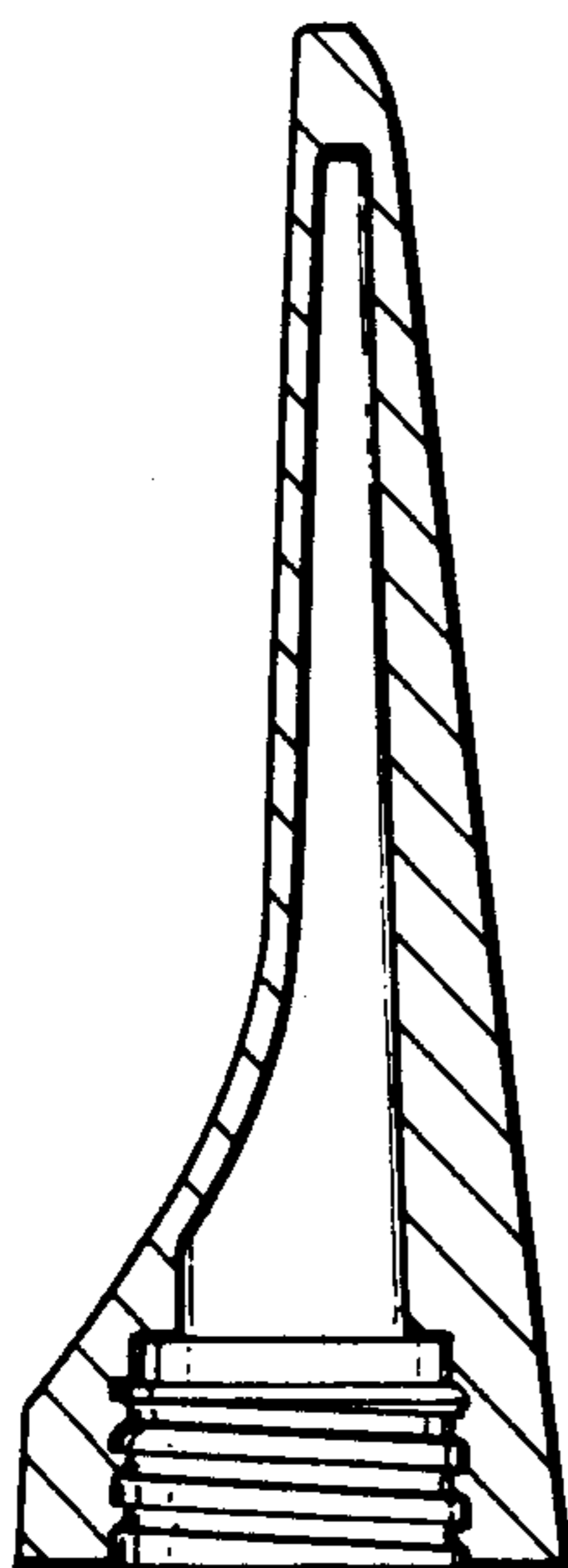
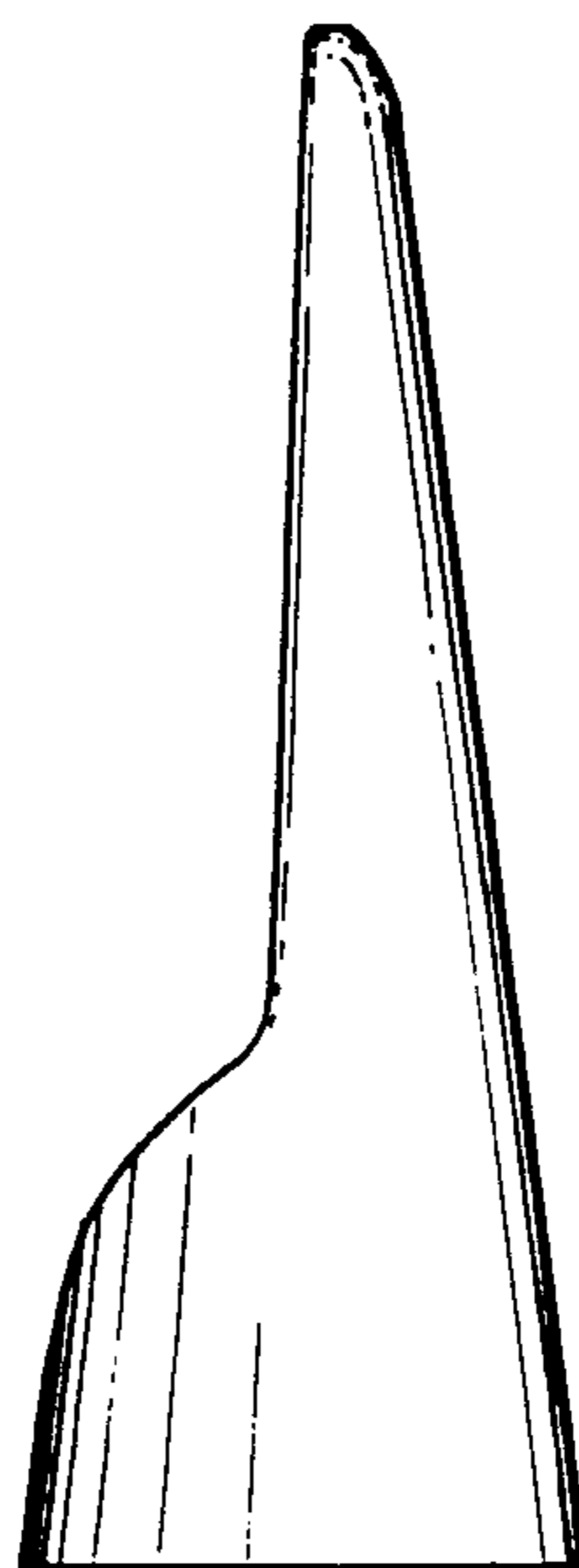
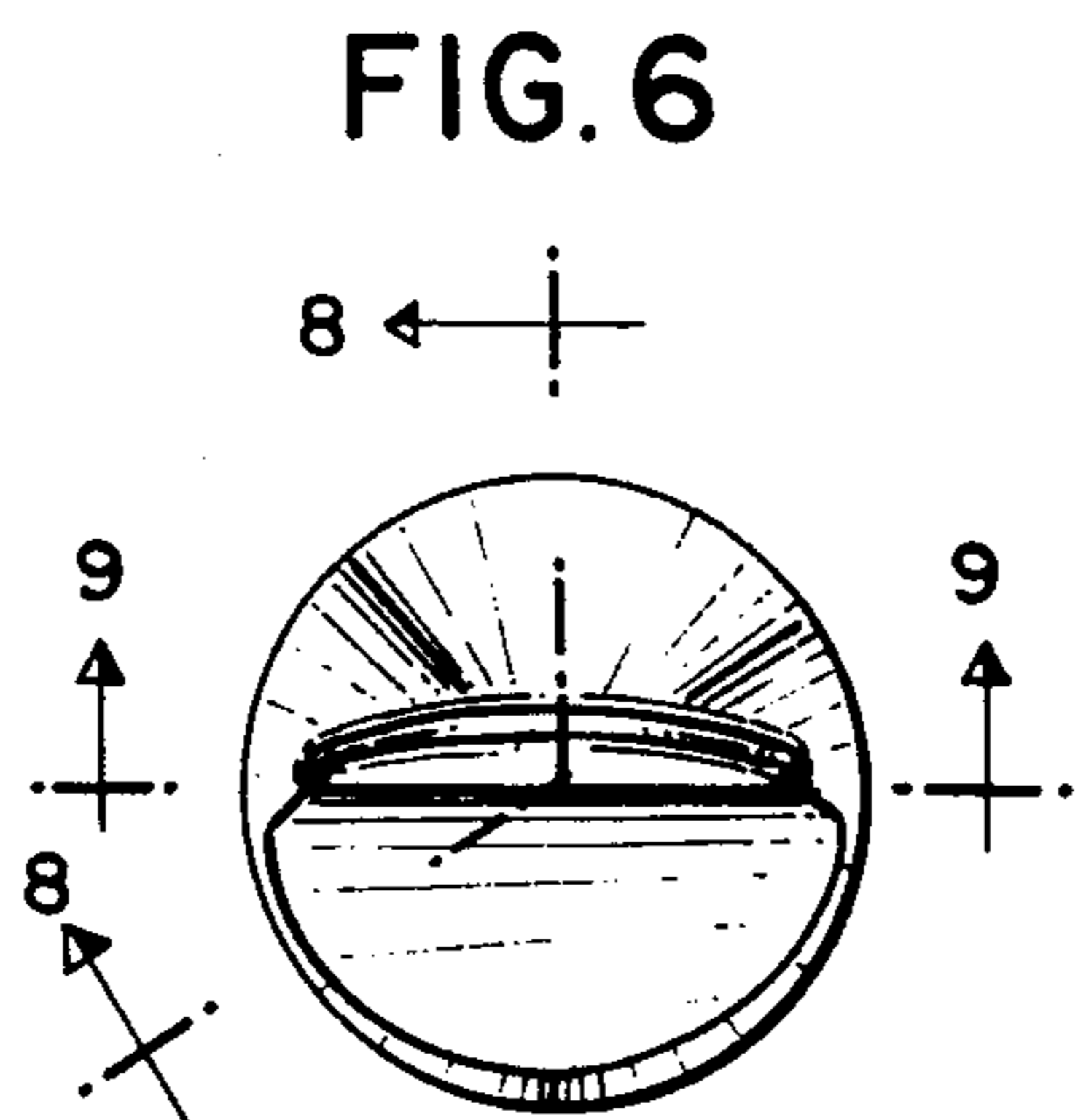
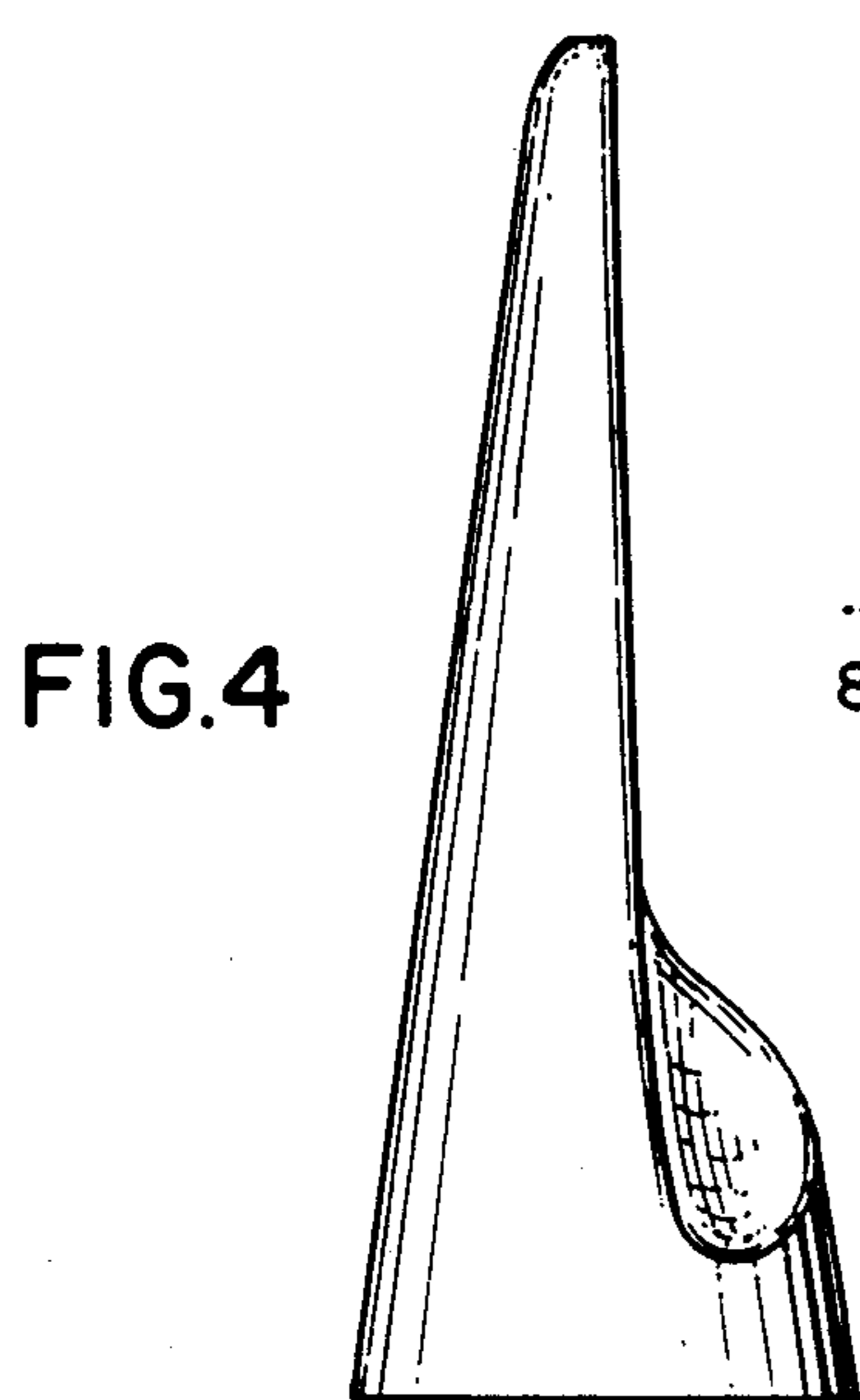

FIG. 3





UNITED STATES PATENT OFFICE
CERTIFICATE OF CORRECTION

Patent No. D-257,229 Dated October 7, 1980

Inventor(s) Jean Leger

It is certified that error appears in the above-identified patent and that said Letters Patent are hereby corrected as shown below:

On the Title page, please insert the following:

--Assigned to Helena Rubinstein, Inc., New York, N.Y. --

Signed and Sealed this
Twenty-fourth Day of February 1981

[SEAL]

Attest:

Attesting Officer

RENE D. TEGMEYER

Acting Commissioner of Patents and Trademarks