

[54] TOY CLOCK

[75] Inventor: Susan M. Matsumoto, New York, N.Y.

[73] Assignee: L.J.N. Toys, Ltd., New York, N.Y.

[**] Term: 14 Years

[21] Appl. No.: 936,024

[22] Filed: Aug. 23, 1978

[51] Int. Cl. D21-01

[52] U.S. Cl. D21/144; D10/7

[58] Field of Search D21/144; D10/7, 25, D10/34

[56] References Cited

U.S. PATENT DOCUMENTS

D. 113,120 1/1939 Schlenker D10/25

D. 163,363 5/1951 Bruce D10/25
D. 210,968 5/1968 Evanston et al. D10/25
1,989,881 2/1935 Putnam D10/34

Primary Examiner—Donald B. Moyer
Attorney, Agent, or Firm—Anthony J. Casella

[57] CLAIM

The ornamental design for a toy clock, as shown.

DESCRIPTION

FIG. 1 is a top plan view of a toy clock showing my new design;
FIG. 2 is a front elevational view;
FIG. 3 is a left side elevational view;
FIG. 4 is a right side elevational view;
FIG. 5 is a rear elevational view;
FIG. 6 is a bottom plan view; and
FIG. 7 is a sectional view thereof taken along lines 7-7 in FIG. 1.

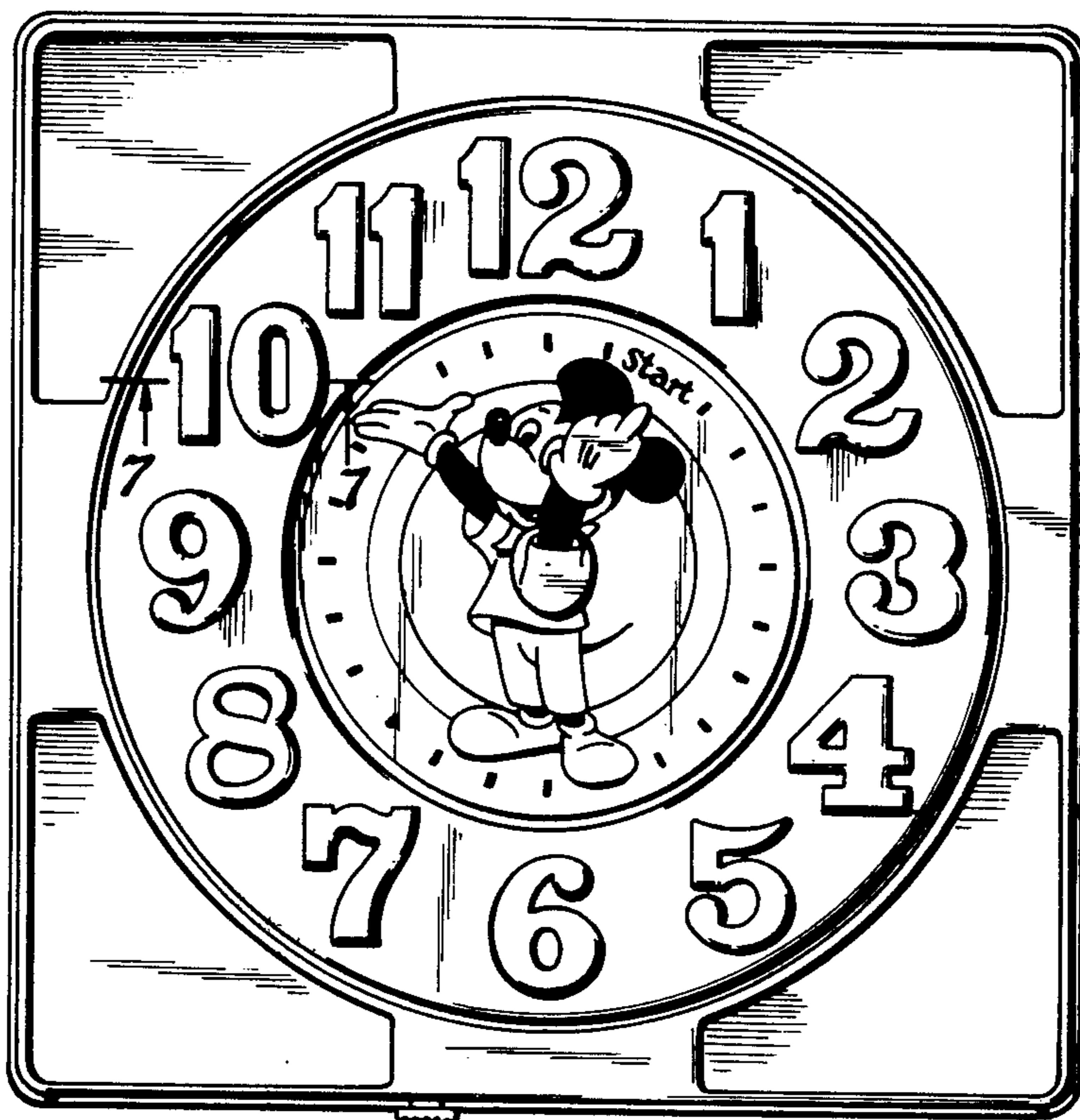

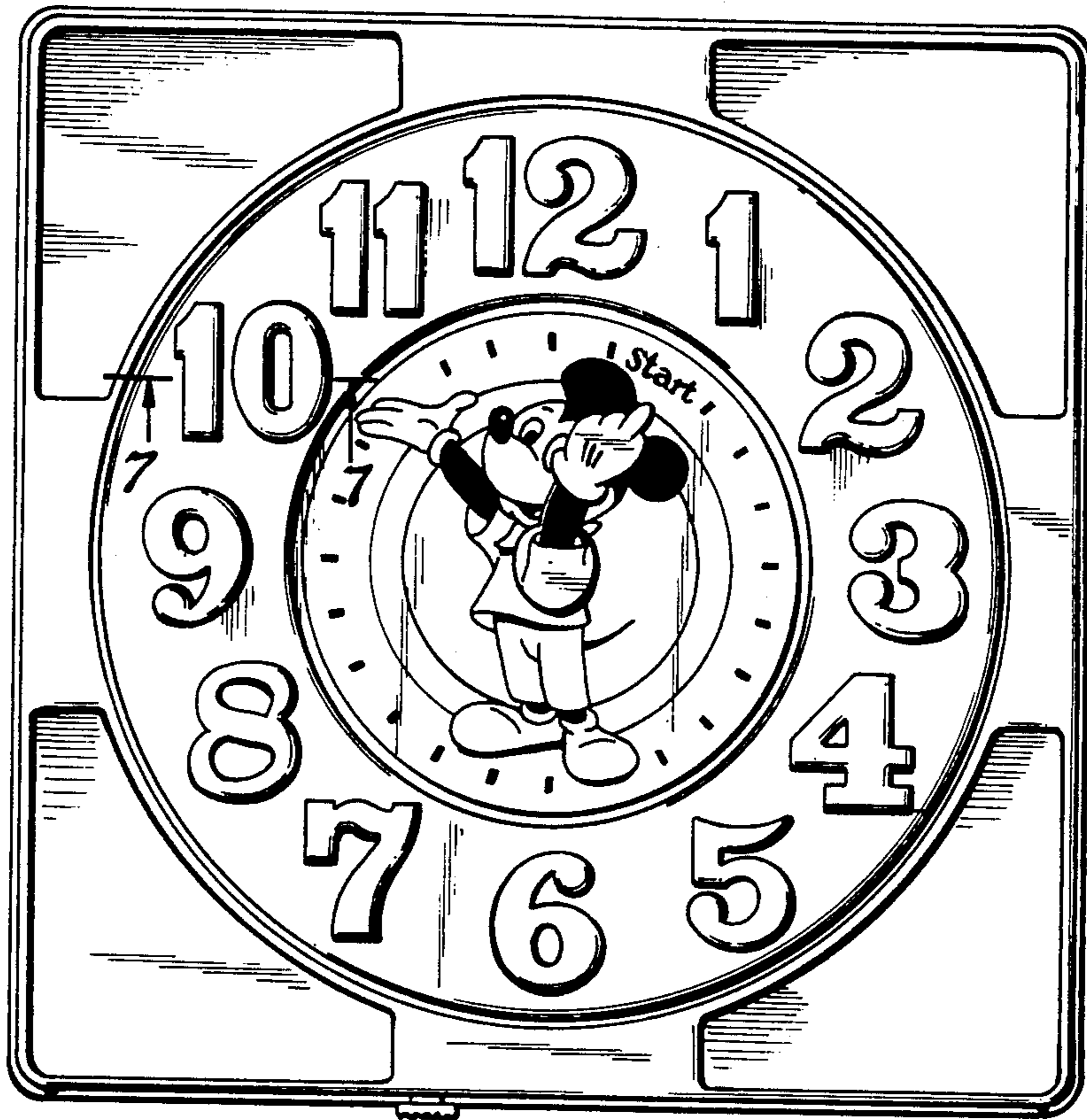

FIG. 1

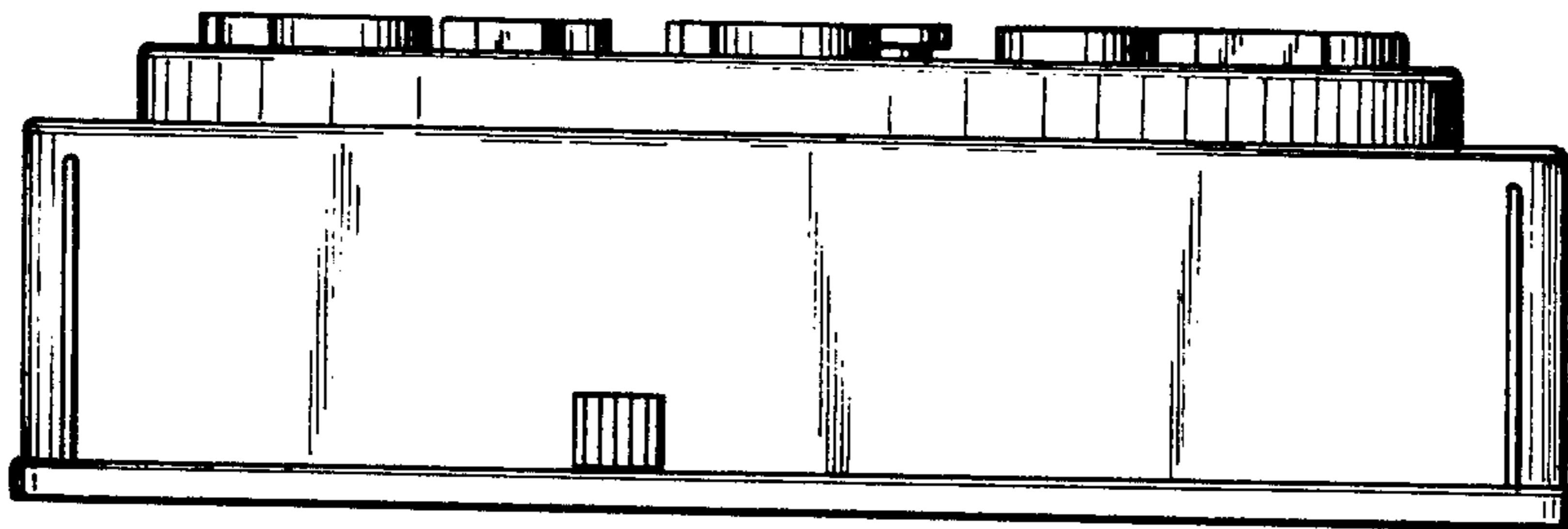

FIG. 2

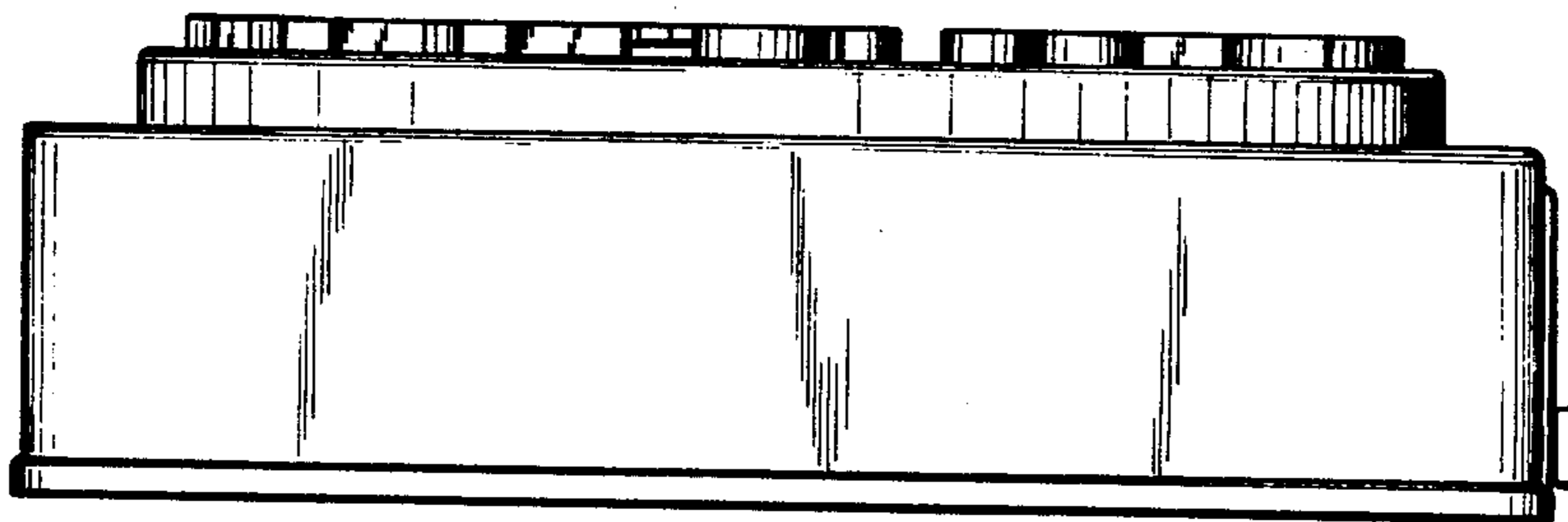

FIG. 3

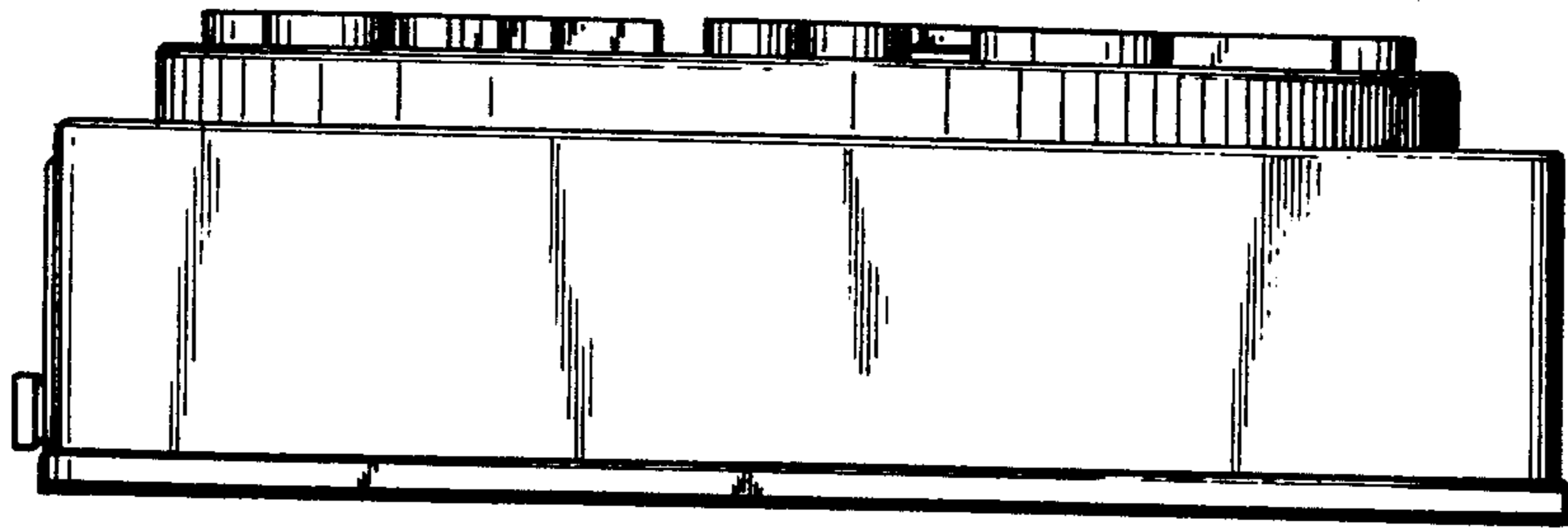

FIG. 4

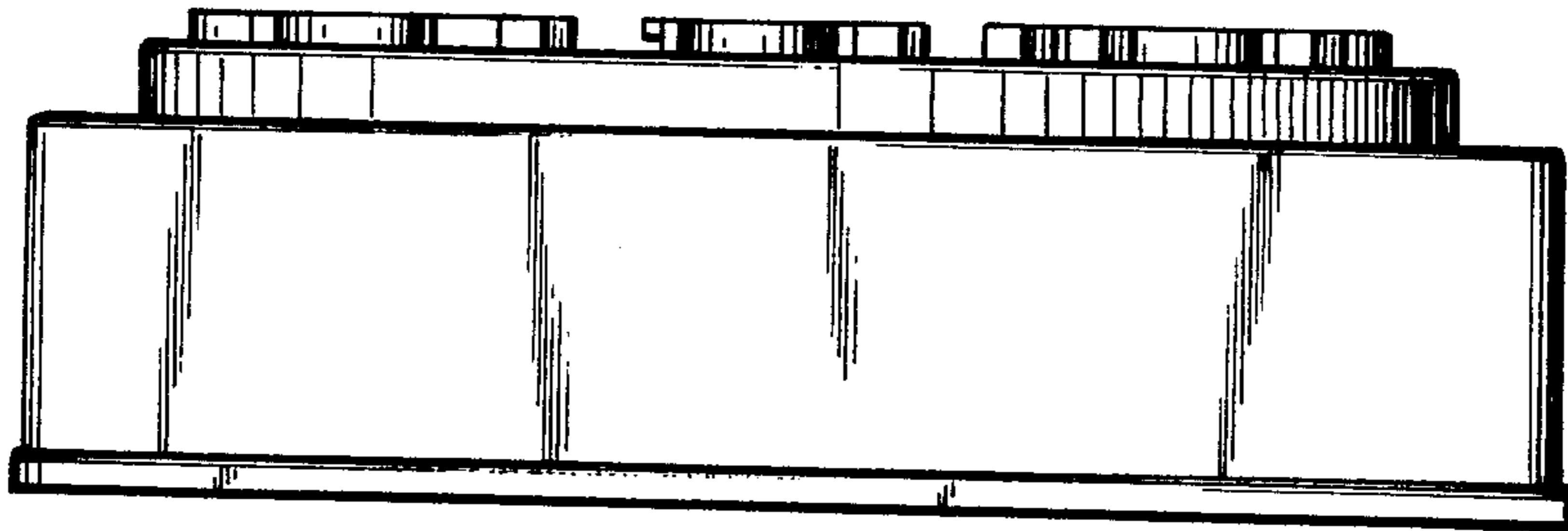

FIG. 5

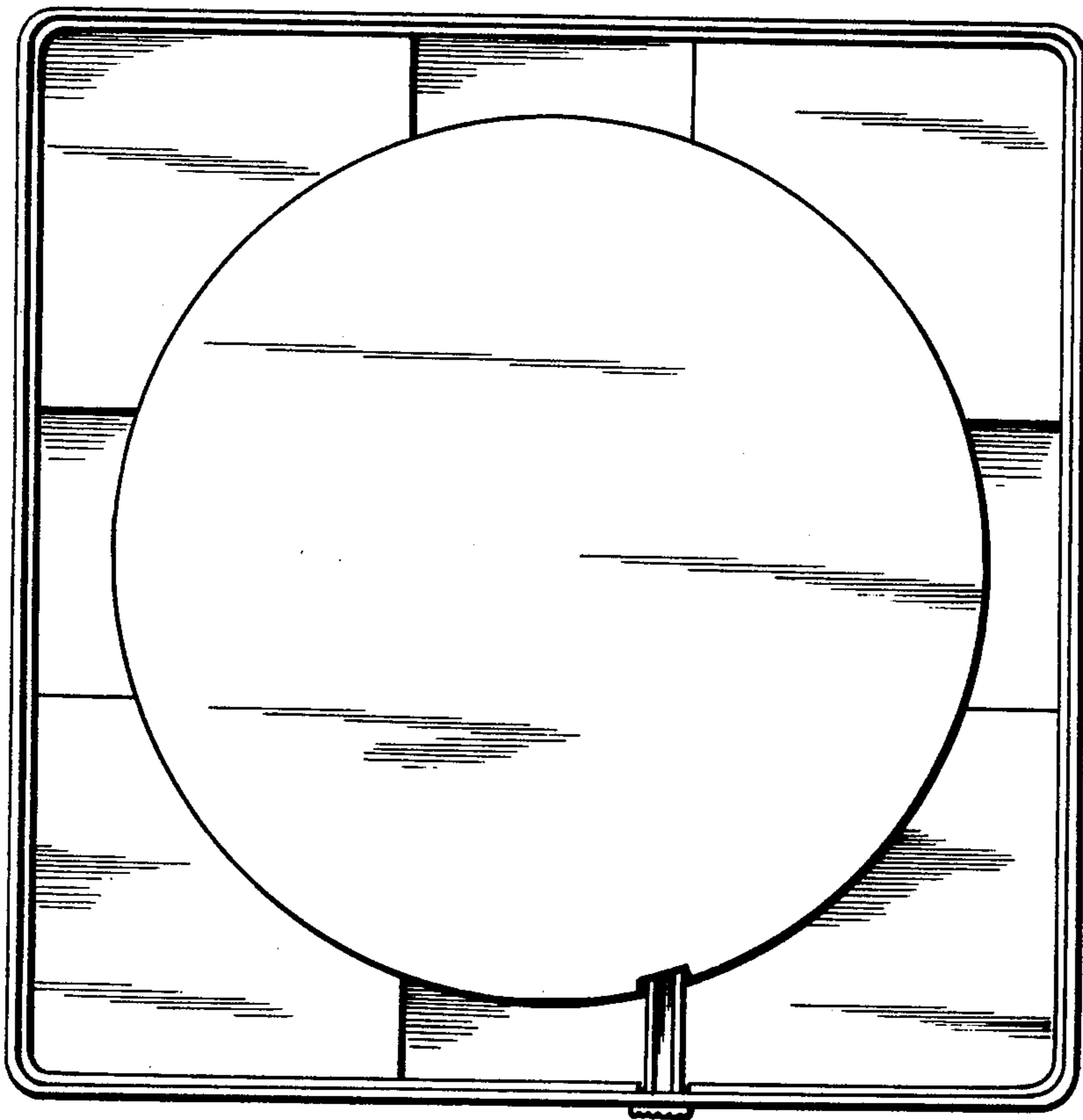

FIG. 6

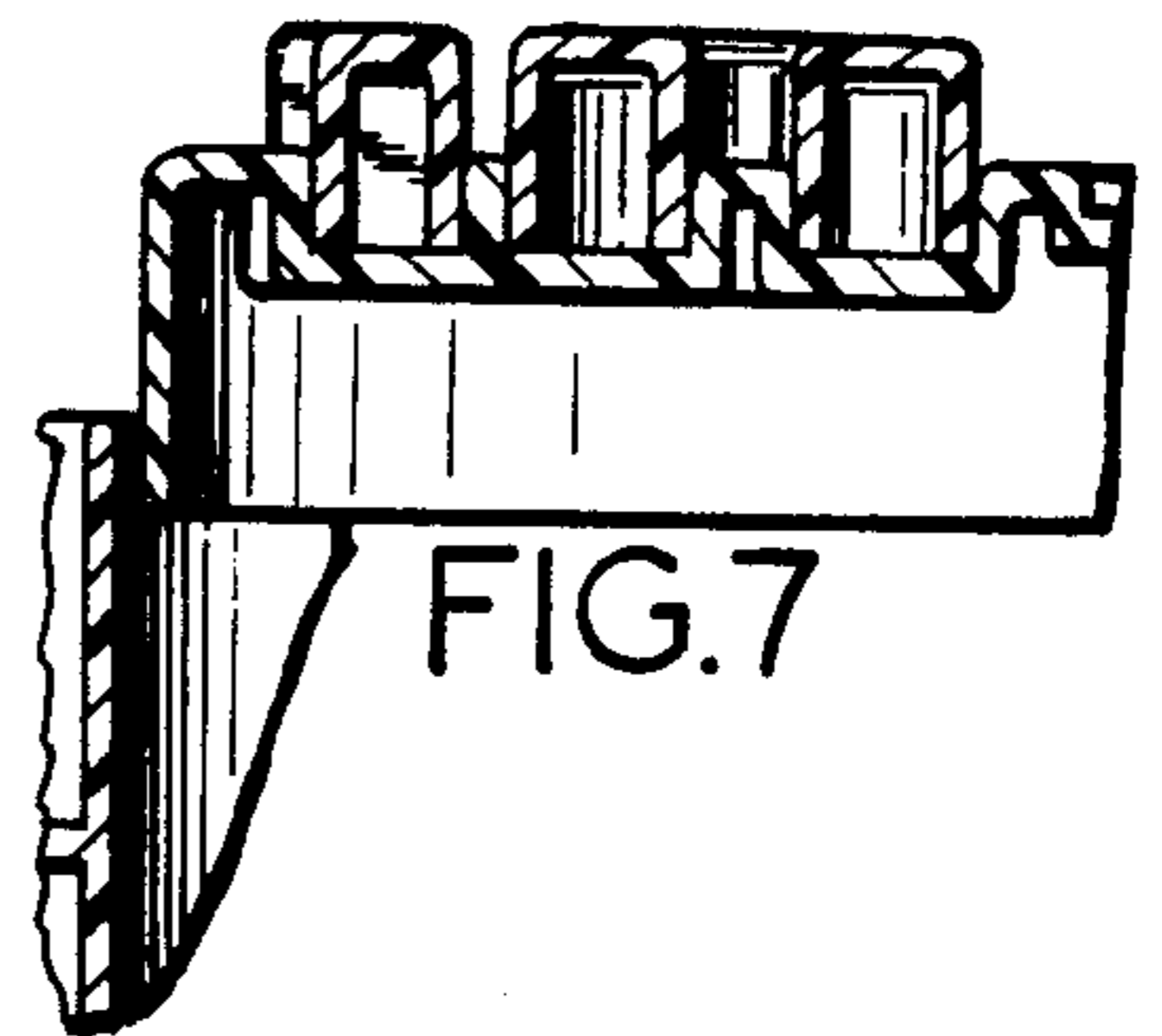

FIG. 7