

[54] FAN HOUSING

D. 211,576 7/1968 Jenn et al. .... D23/155  
D. 249,158 8/1978 Morrow ..... D23/158

[75] Inventor: Wilford R. Mann, Niles, Mich.

Primary Examiner—James R. Largen  
Attorney, Agent, or Firm—Marmaduke A. Hobbs

[73] Assignee: AAA Associates Inc., Niles, Mich.

[\*\*] Term: 14 Years

[57] CLAIM

[21] Appl. No.: 812,002

The ornamental design for a fan housing, substantially as shown.

[22] Filed: Jun. 30, 1977

DESCRIPTION

[51] Int. Cl. .... D23-04

[52] U.S. Cl. .... D23/163

[58] Field of Search ..... D23/151-165;  
415/72, 73, 200, 219 R

FIG. 1 is a front perspective view of a fan housing embodying my new design;

FIG. 2 is a rear perspective view thereof;

FIG. 3 is a side elevational view thereof;

FIG. 4 is a top plan view thereof;

FIG. 5 is a bottom plan view thereof;

FIG. 6 is a rear elevational view thereof; and

FIG. 7 is a front elevational view thereof.

[56] References Cited

U.S. PATENT DOCUMENTS

D. 129,935 10/1941 Wilcoxson ..... D23/158

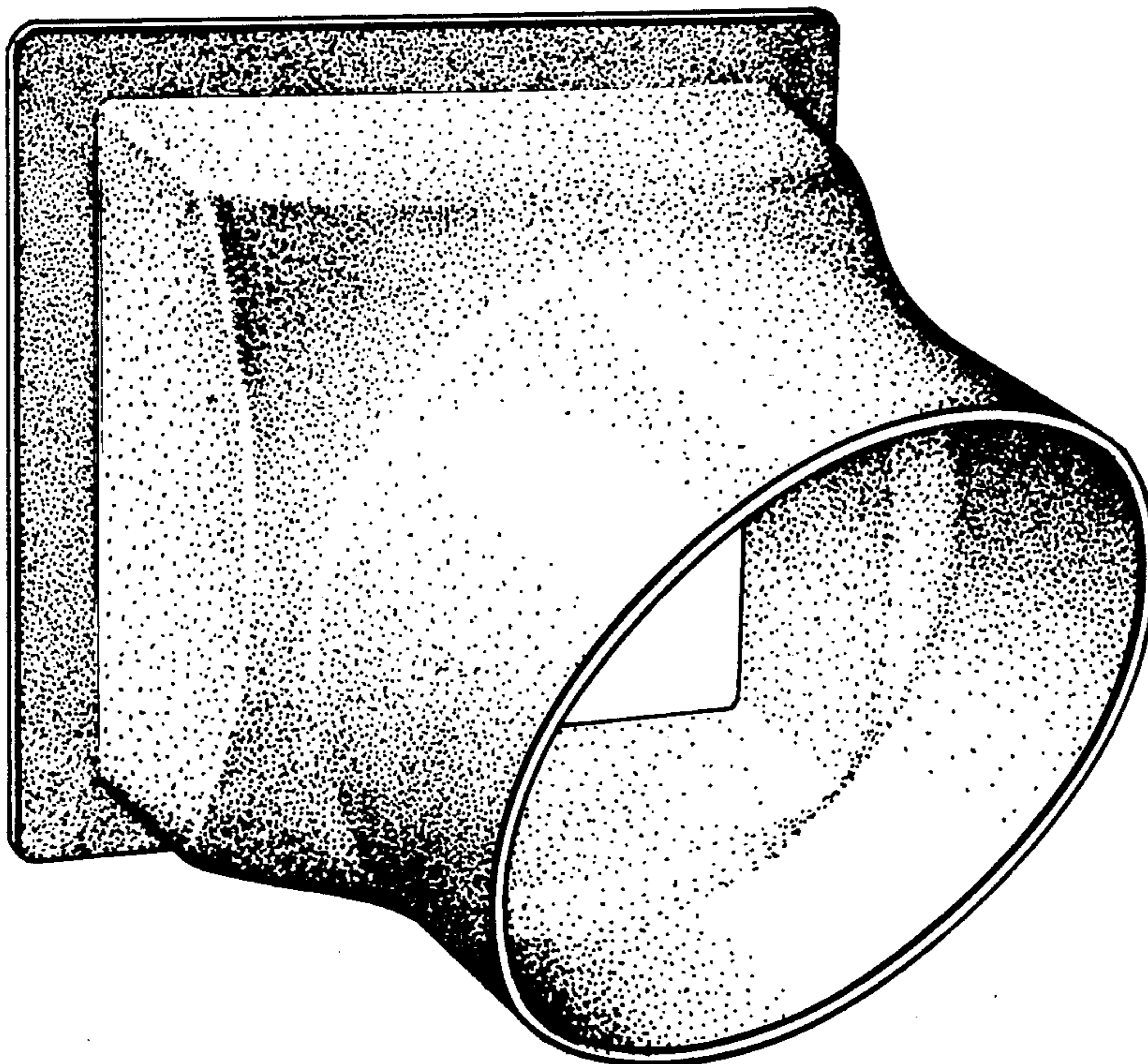

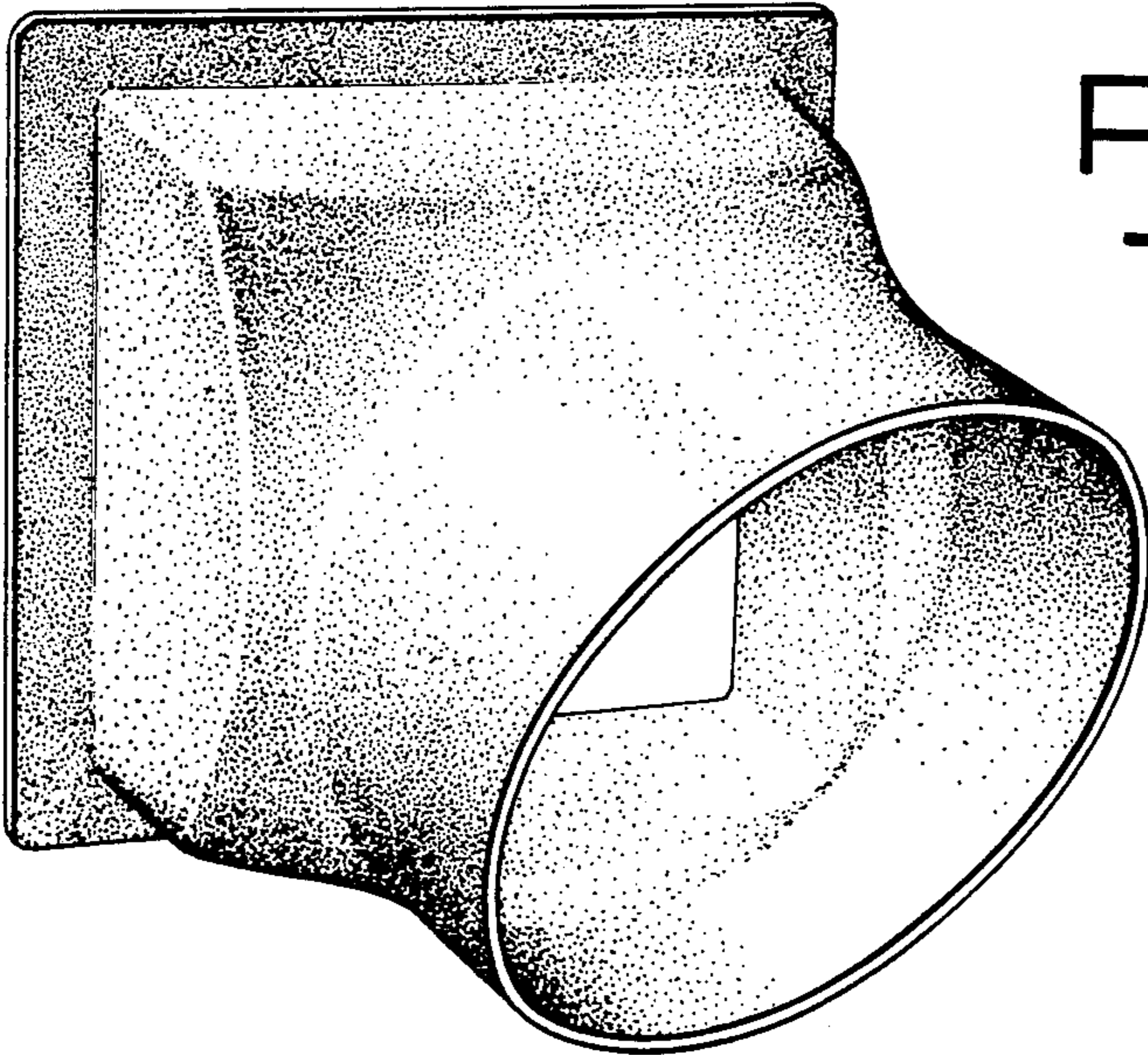

Fig. 1

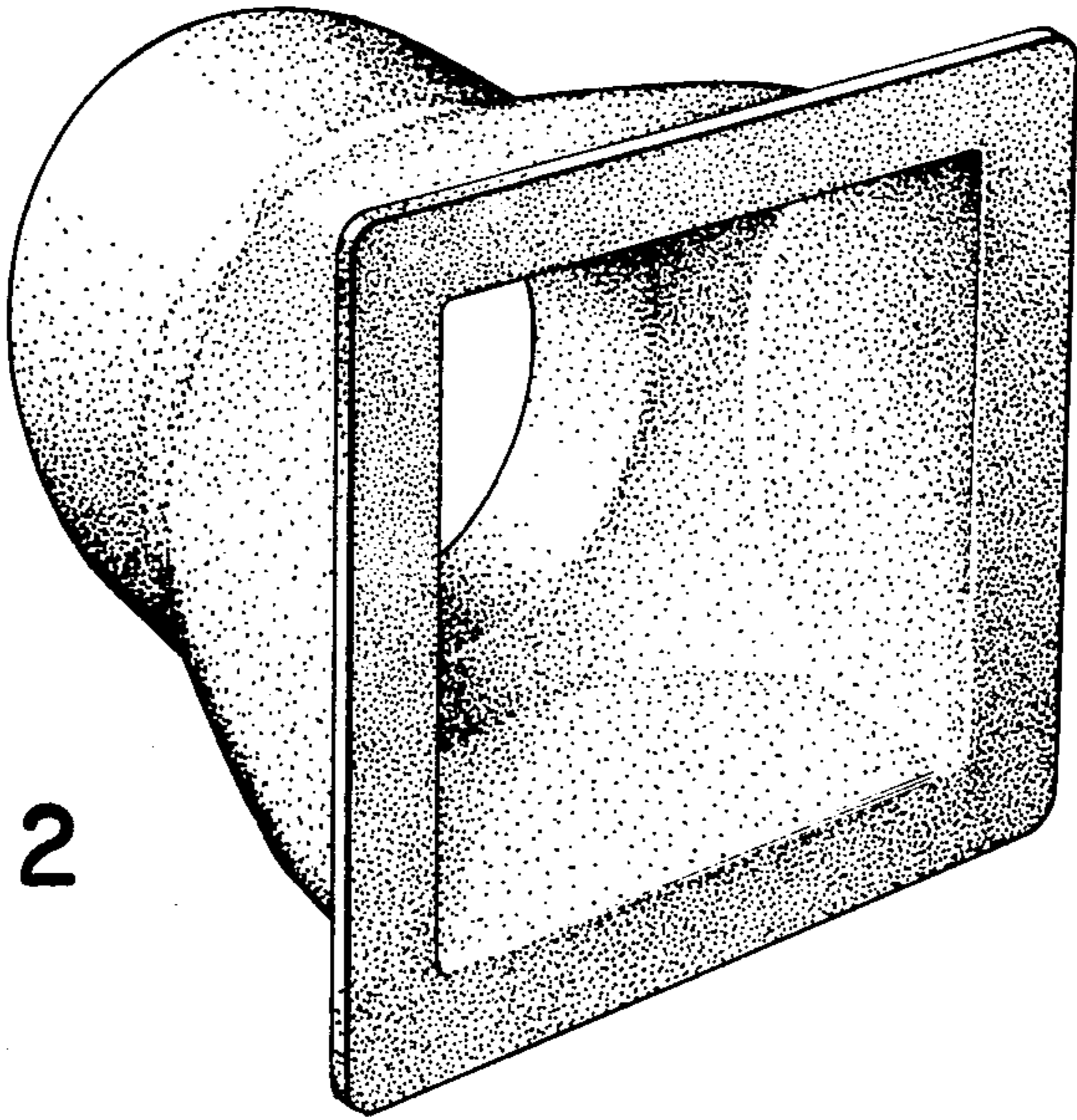

Fig. 2

Fig. 3

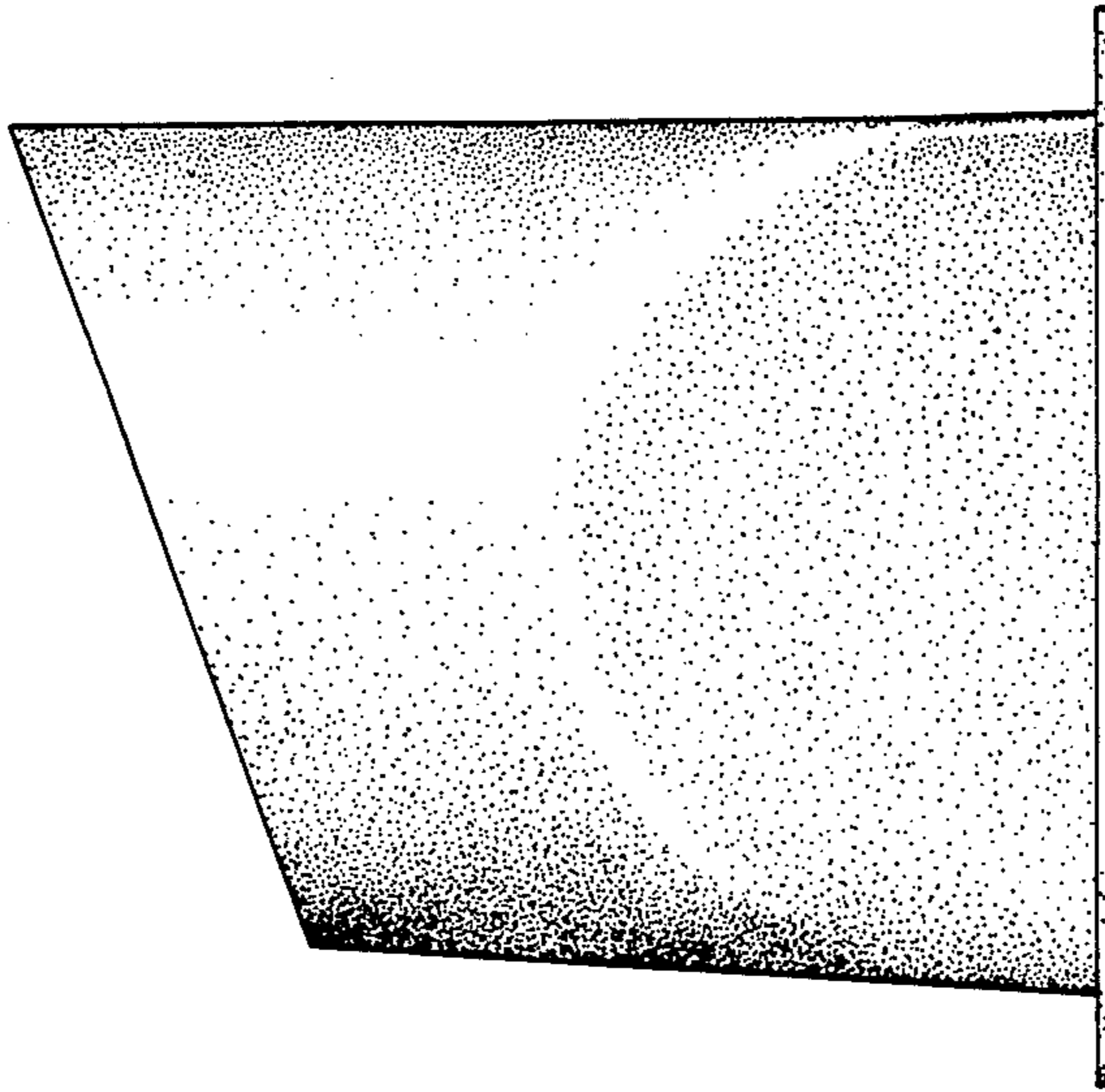

Fig. 4

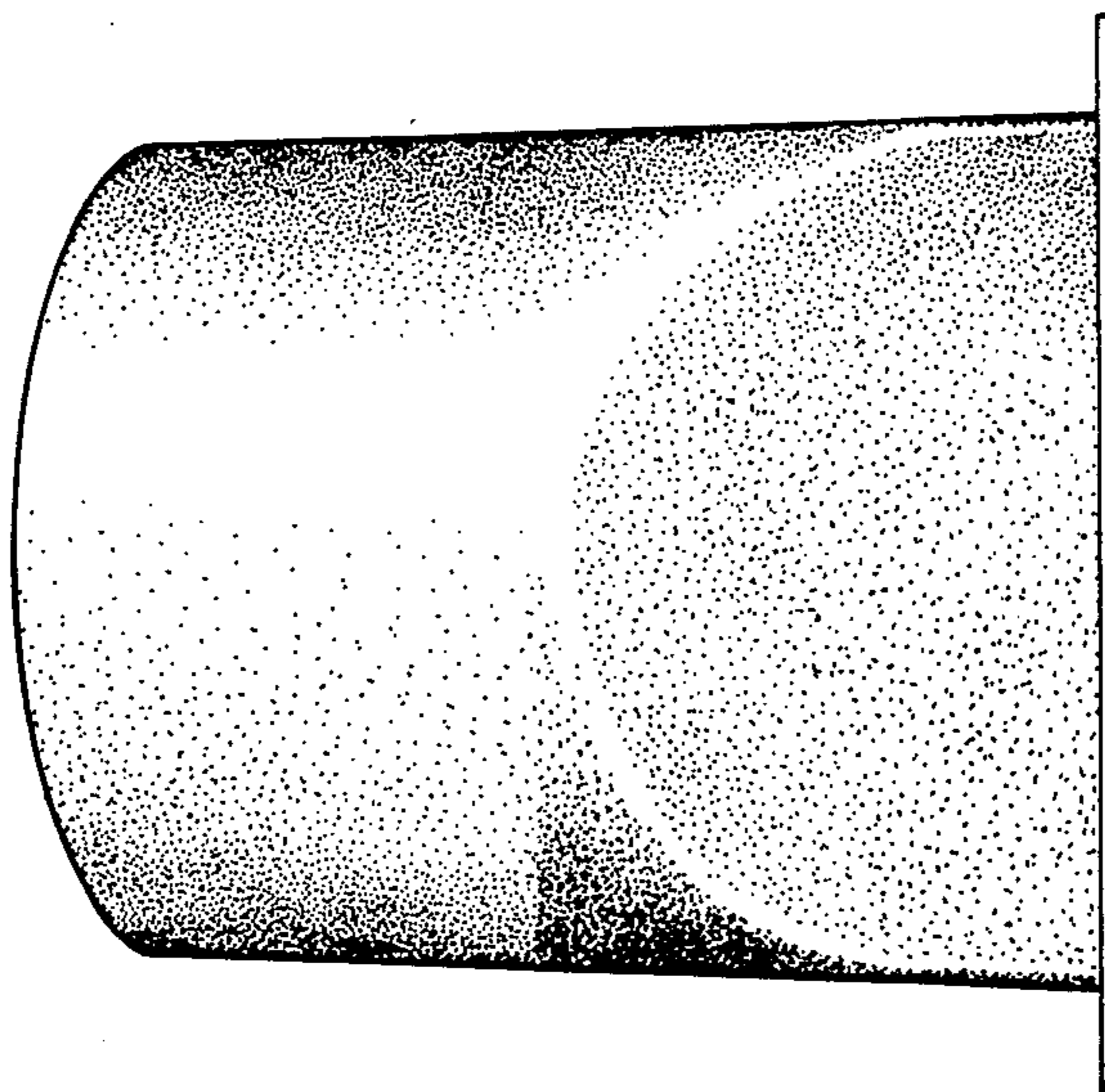

Fig. 5

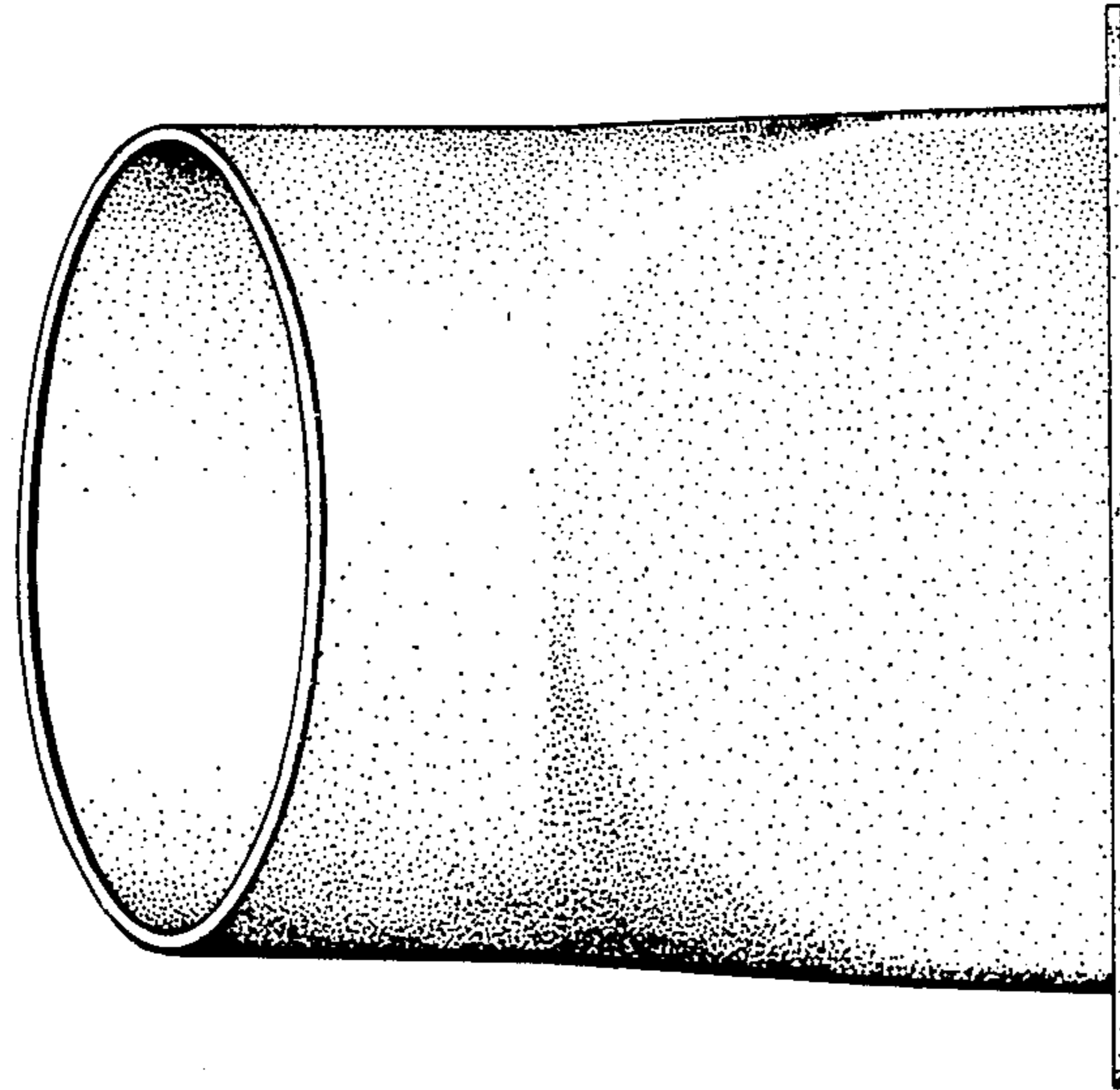

Fig. 6

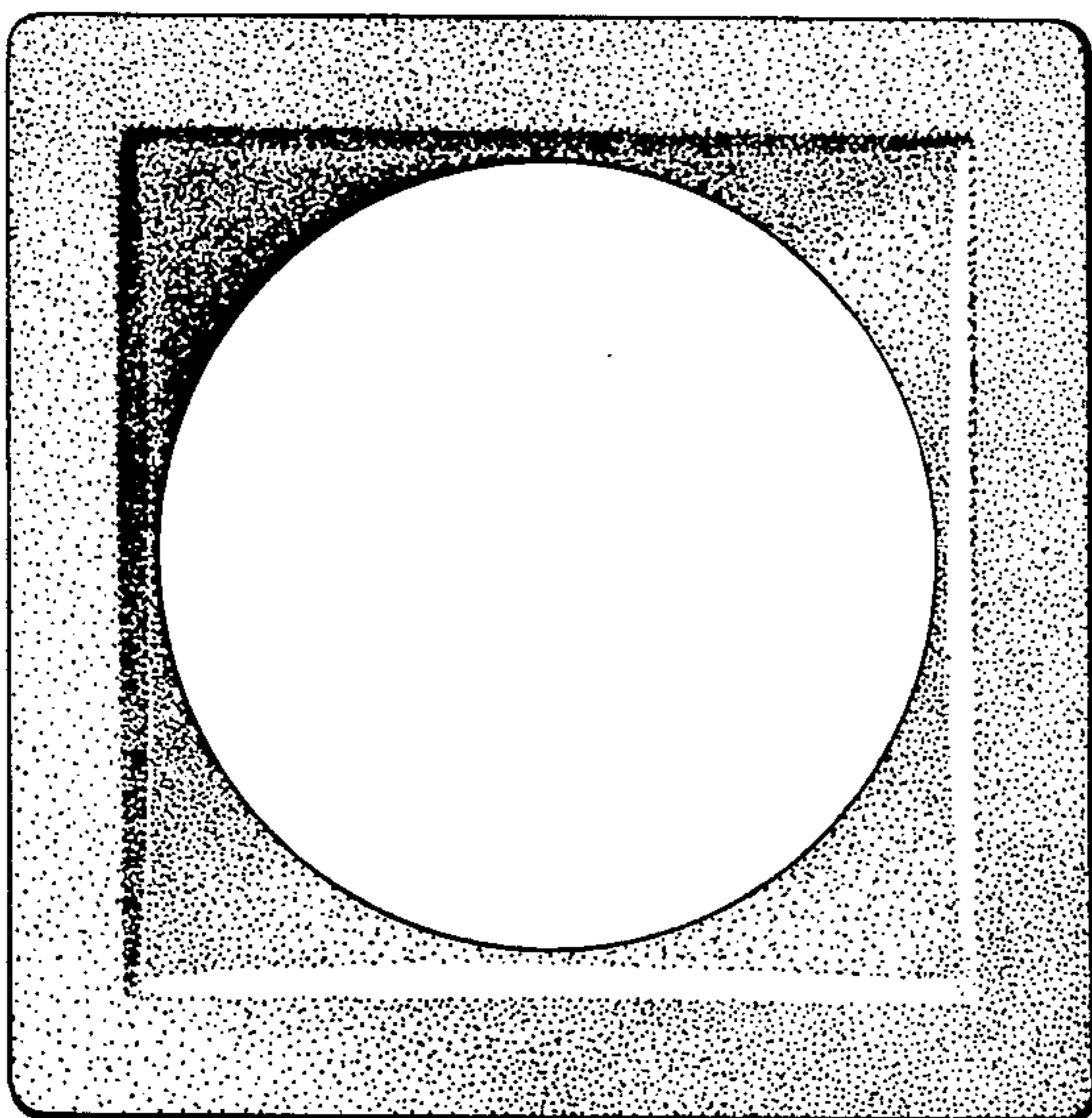

Fig. 7

