

[54] **HOLDER FOR PRINTED WIRING BOARDS OR THE LIKE**

[75] Inventor: **William B. Webster**, Huntington Beach, Calif.

[73] Assignee: **Xerox Corporation**, Stamford, Conn.

[\*\*] Term: **14 Years**

[21] Appl. No.: **966,671**

[22] Filed: **Dec. 5, 1978**

[51] Int. Cl. .... **D6—04**

[52] U.S. Cl. .... **D6/140; D3/68; D3/69; D9/189; 206/328; 206/564**

[58] Field of Search ..... **D3/30, 67, 68, 69, 73, D3/74; D6/140, 146, 148, 157, 175, 181, 184, 185, 186, 187, 188; D9/189; 206/328, 329, 558, 564; 211/40, 41, 42, 50**

[56] **References Cited**

**U.S. PATENT DOCUMENTS**

2,249,851 7/1941 Pilliod et al. .... 206/564

*Primary Examiner*—George G. Stellar  
*Attorney, Agent, or Firm*—J. J. Ralabate

[57] **CLAIM**

The ornamental design for a holder for printed wiring boards or the like, as shown.

**DESCRIPTION**

FIG. 1 is a perspective view of a holder for printed wiring boards or the like showing my new design.

FIG. 2 is a front elevational view thereof.

FIG. 3 is a top plan view thereof.

FIG. 4 is a rear elevational view thereof.

FIG. 5 is a bottom plan view thereof.

FIG. 6 is a right side elevational view thereof.

FIG. 7 is a left side elevational view thereof.

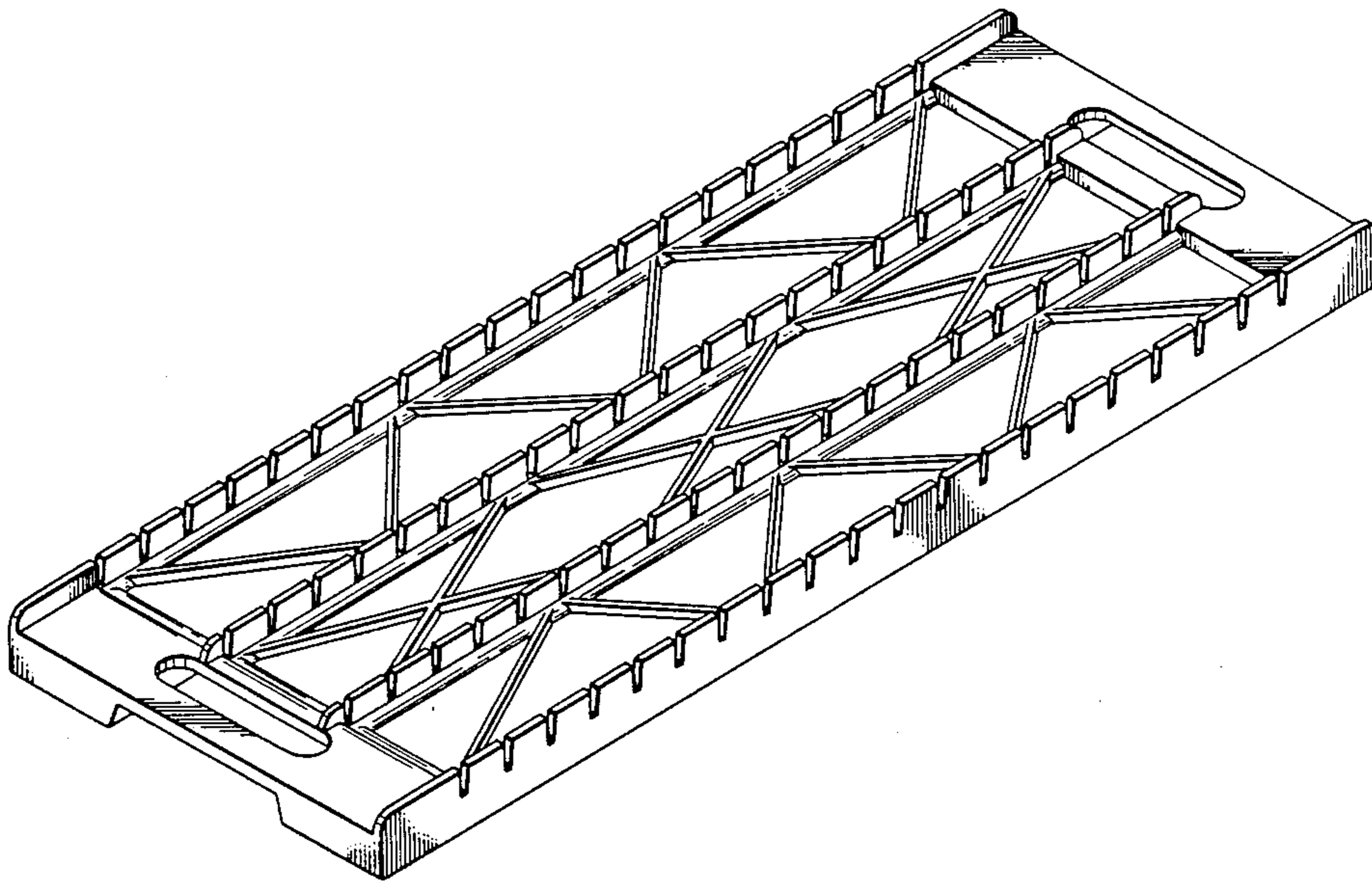

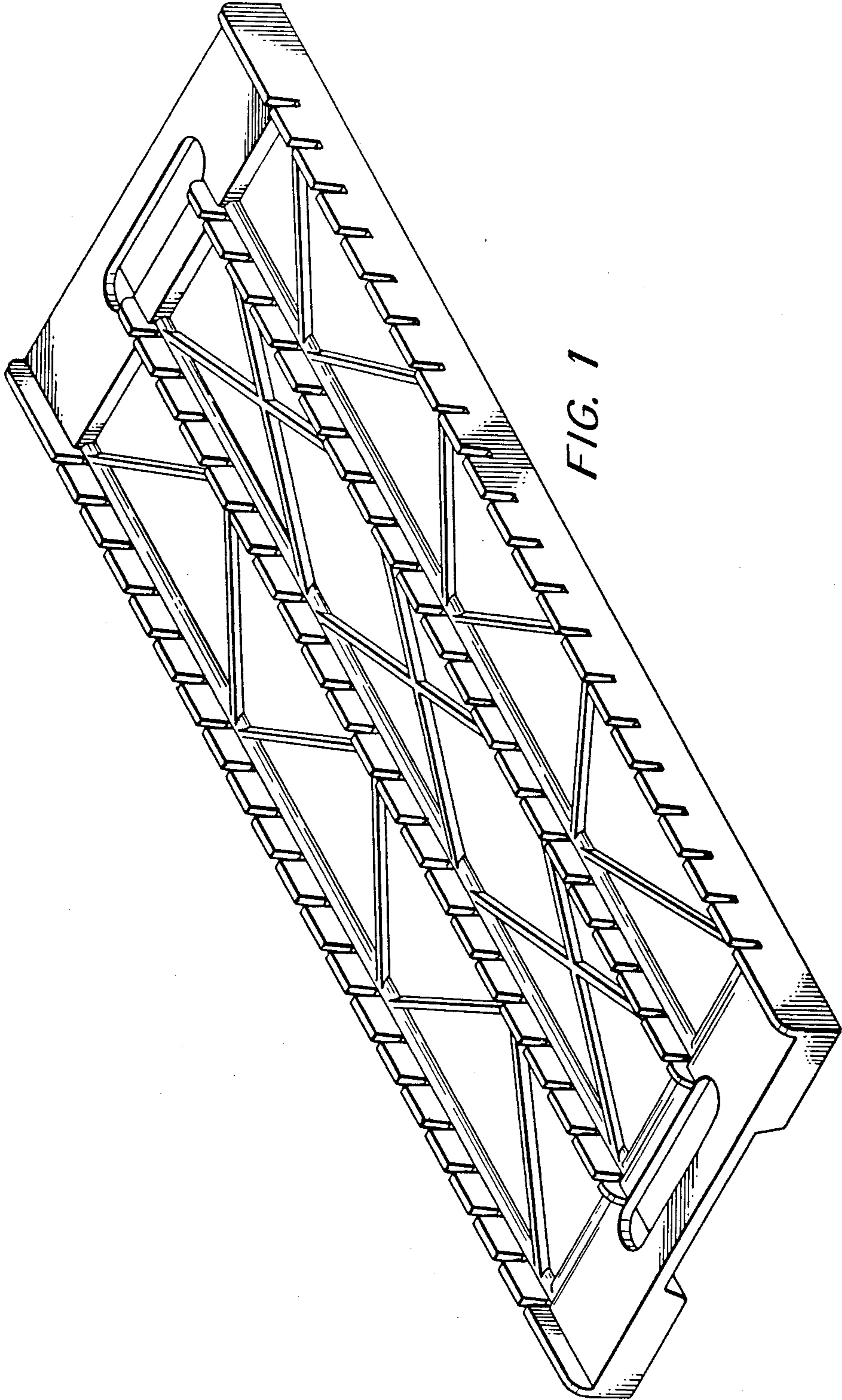

FIG. 1

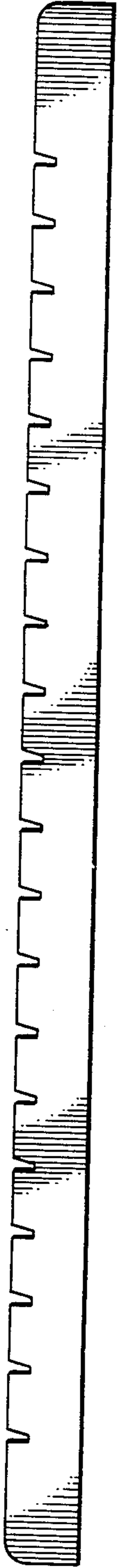

FIG. 2

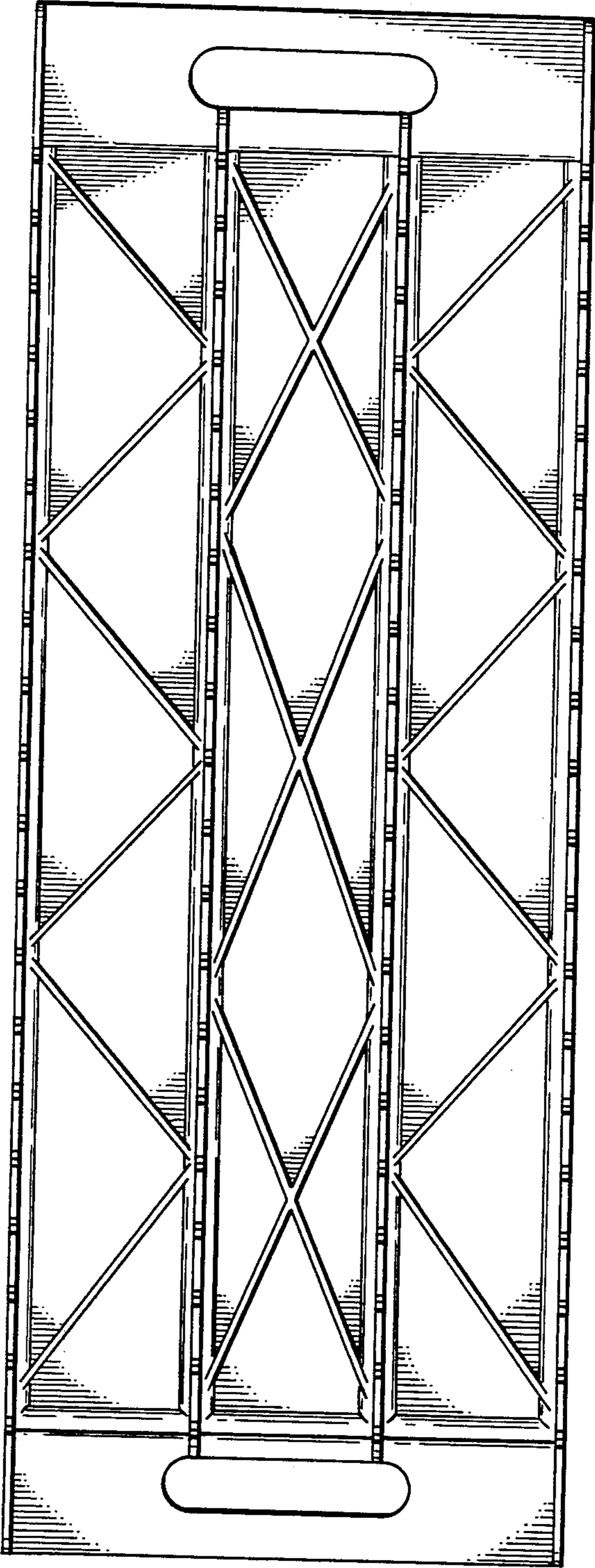
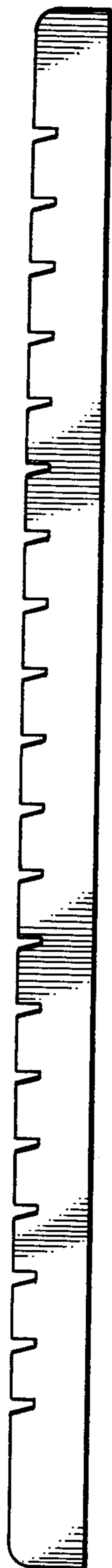
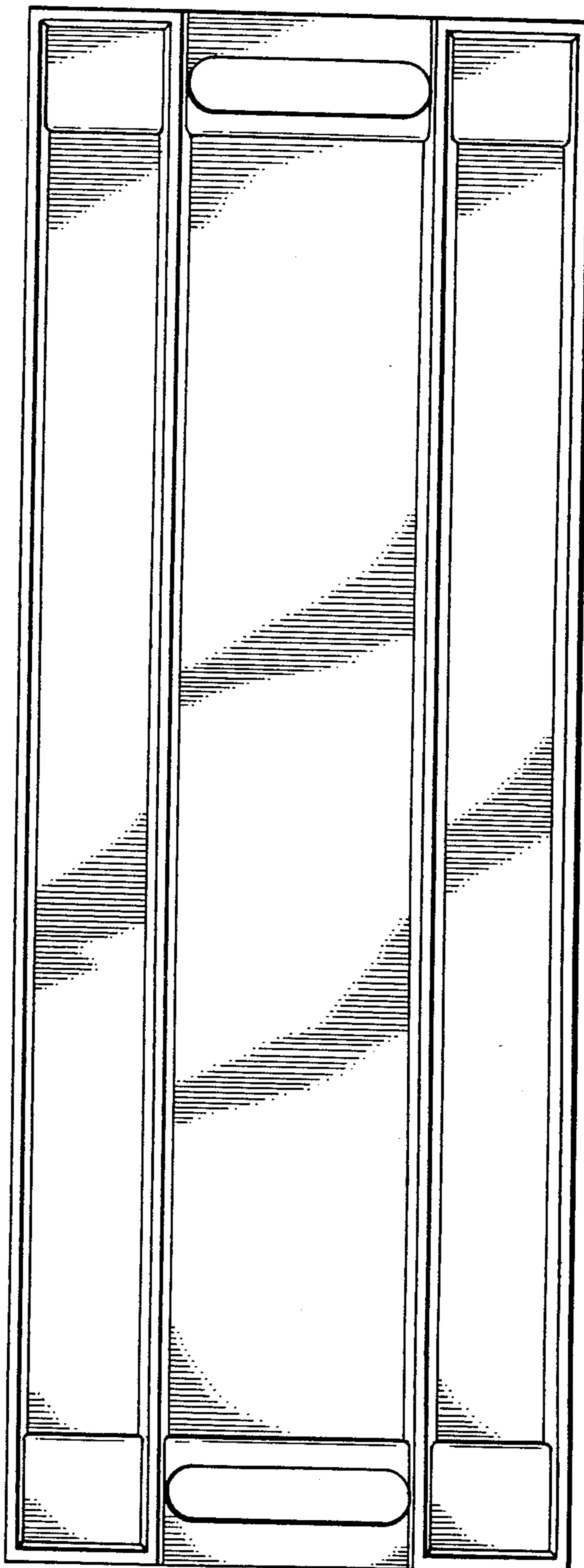

FIG. 3



*FIG. 4*



*FIG. 5*

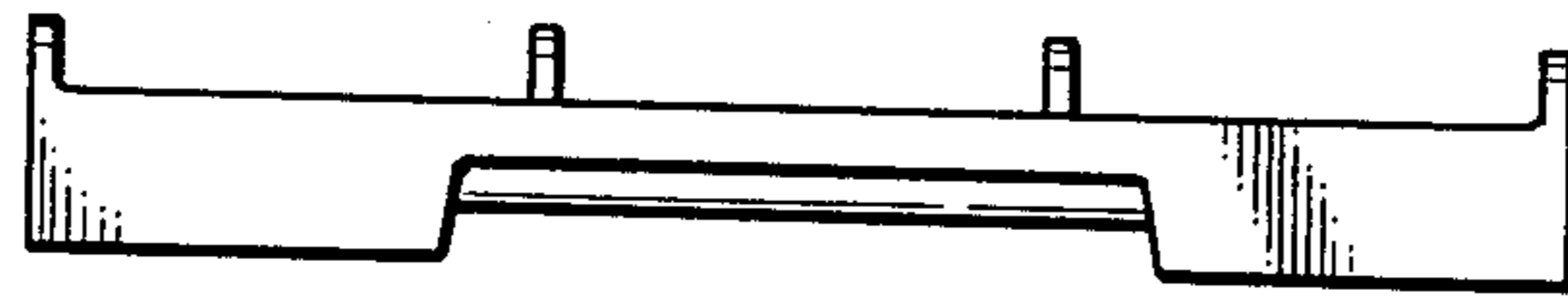

*FIG. 6*

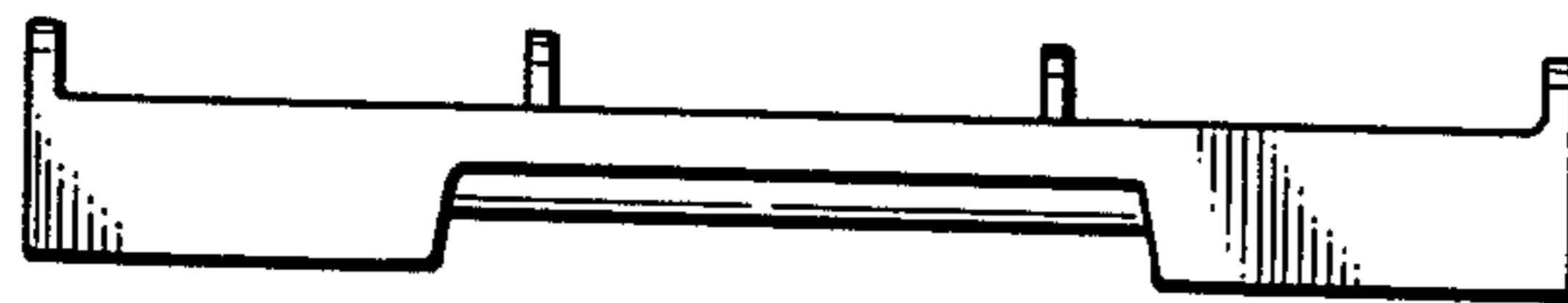

*FIG. 7*