

[54] FLOOR SWEEPER

[75] Inventors: Akira Kubota, Abiko; Kei Utsunomiya, Tokyo, both of Japan

[73] Assignee: Hukuba Kogyo Kabushiki Kaisha, Nagareyama, Japan

[\*\*] Term: 14 Years

[21] Appl. No.: 882,952

[22] Filed: Feb. 28, 1978

[30] Foreign Application Priority Data  
Jan. 20, 1978 [JP] Japan ..... 53-1372

[51] Int. Cl. .... D7-05  
[52] U.S. Cl. .... D7/175  
[58] Field of Search ..... D7/175, 176, 177;  
D15/52, 53, 54, 55; 15/41 R-48, 320, 321

[56] References Cited

U.S. PATENT DOCUMENTS

D. 94,115	12/1934	Burch .....	15/41 R X
D. 236,423	8/1975	Mantelet .....	D15/52 X
3,871,051	3/1975	Collier .....	15/321
4,107,809	8/1978	Schuelein et al. ....	15/42

FOREIGN PATENT DOCUMENTS

1241625	8/1971	United Kingdom .....	15/41 R
---------	--------	----------------------	---------

Primary Examiner—Catherine E. Kemper  
Attorney, Agent, or Firm—V. M. Creedon

[57] CLAIM

The ornamental design for a floor sweeper, as shown.

DESCRIPTION

FIG. 1 is a perspective view of a floor sweeper showing our new design;  
FIG. 2 is a front elevational view thereof;  
FIG. 3 is a rear elevational view thereof;  
FIG. 4 is a right side elevational view thereof;  
FIG. 5 is a left side elevational view thereof;  
FIG. 6 is a top plan view thereof; and  
FIG. 7 is a bottom plan view thereof.

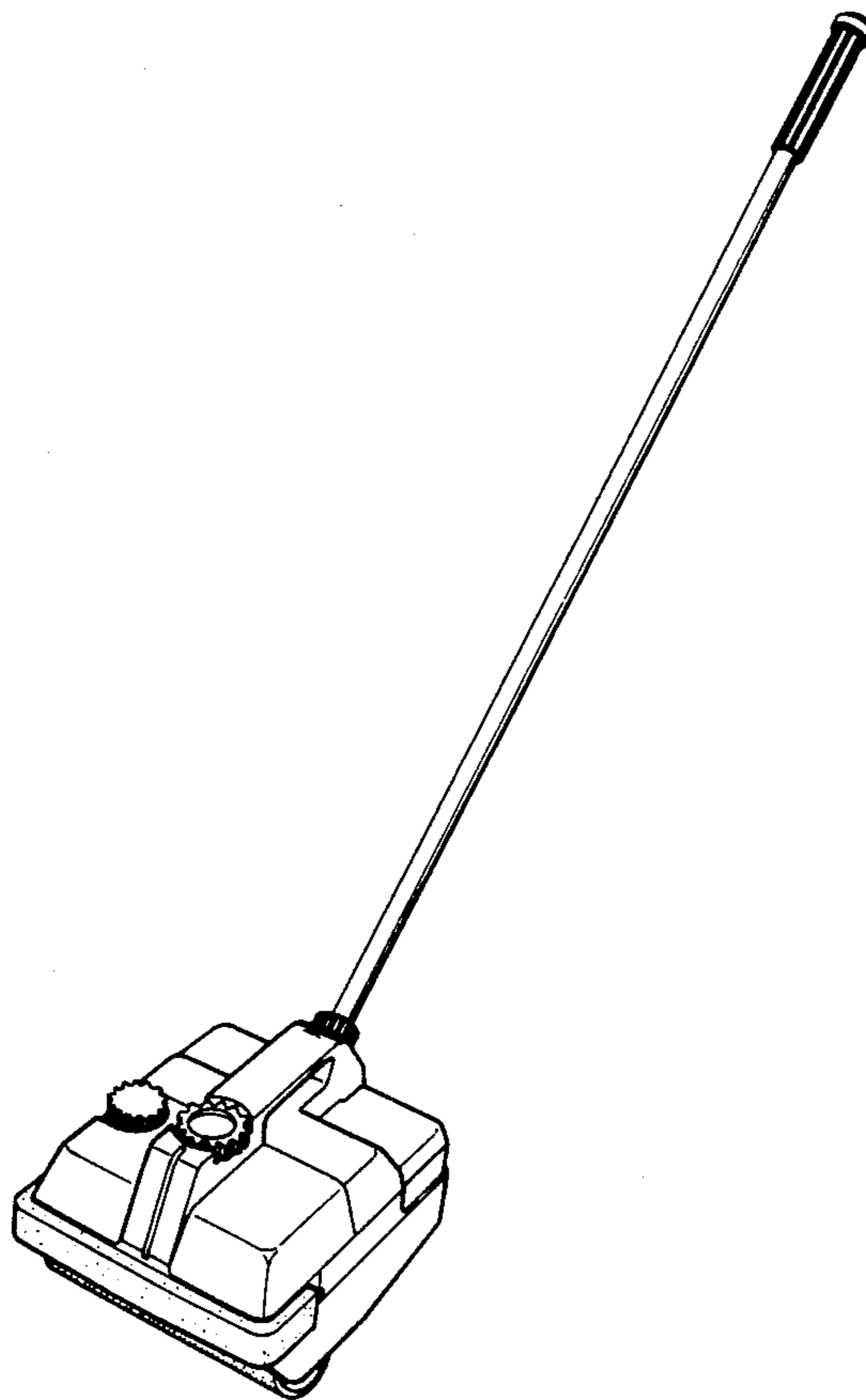

FIG. 1

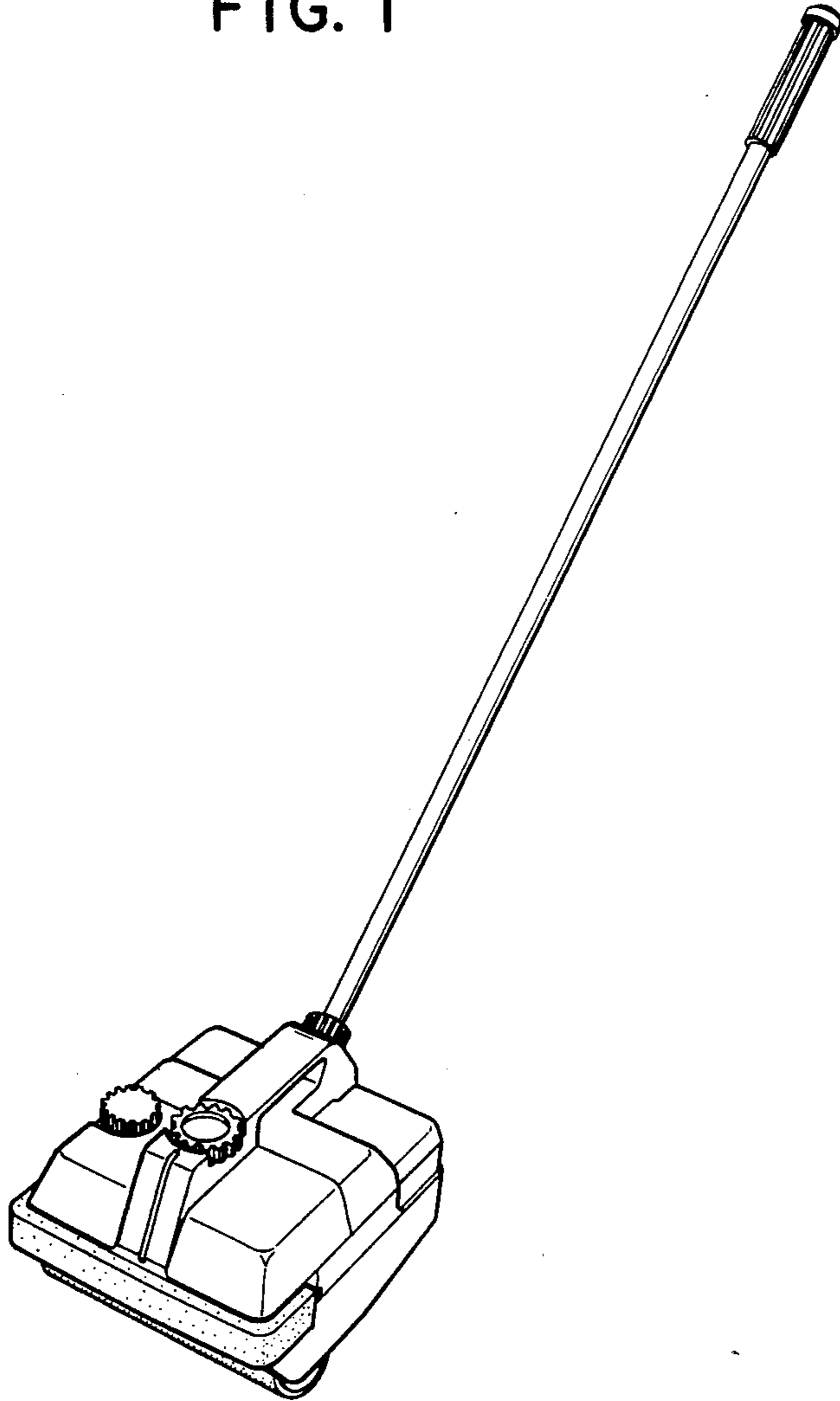

FIG. 2

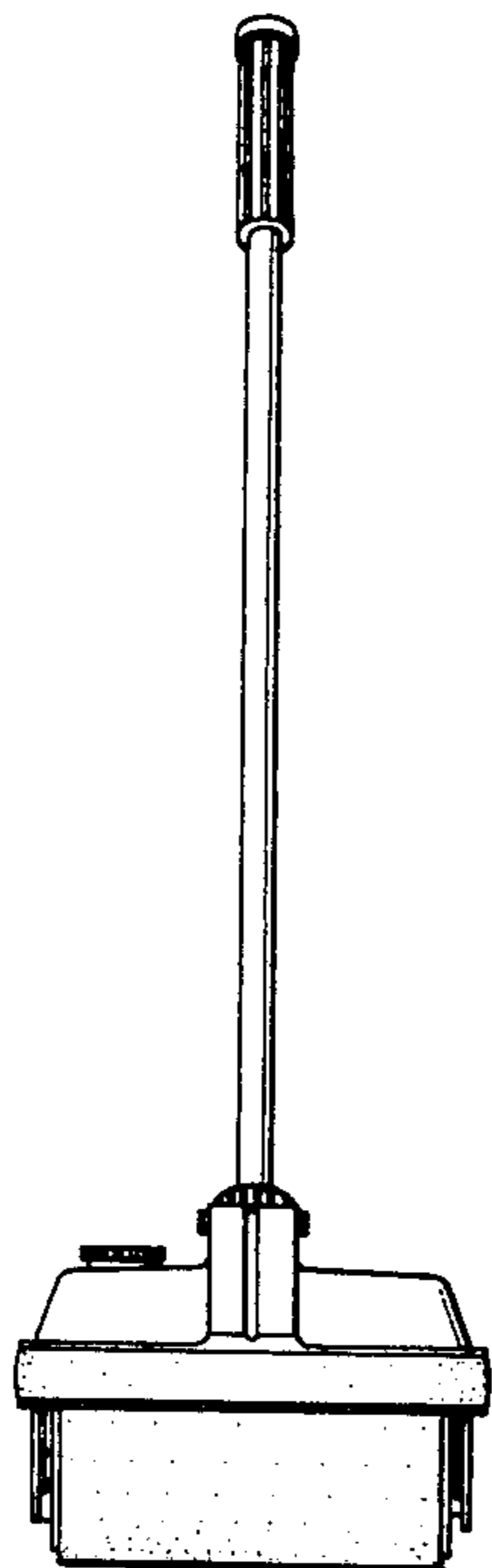

FIG. 3

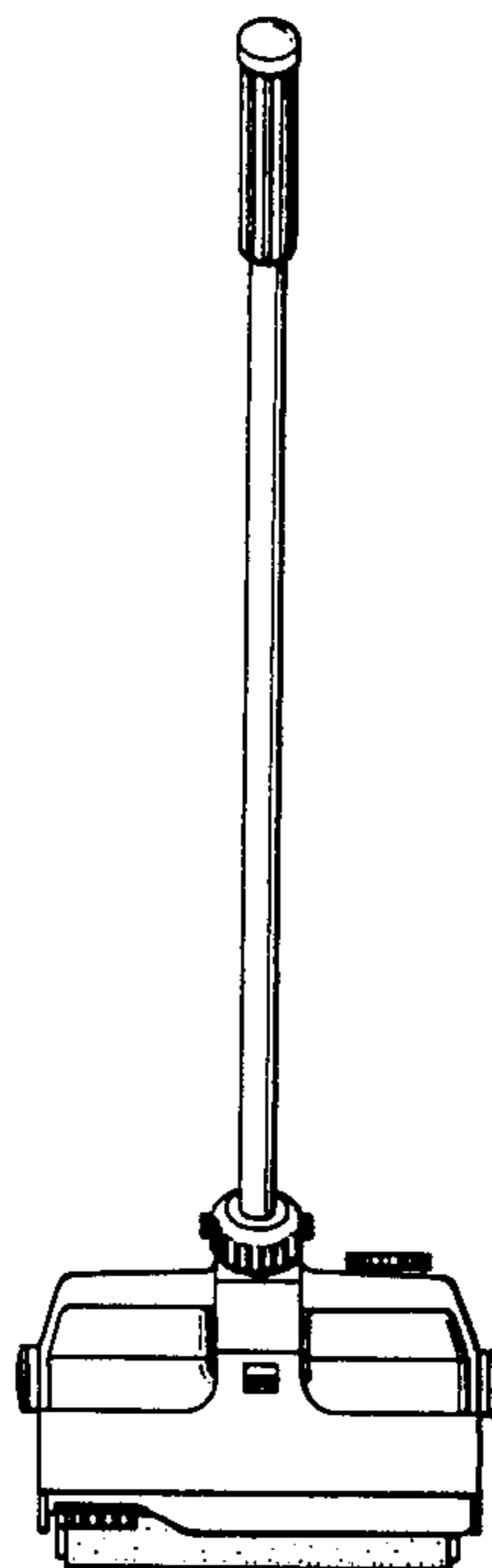

FIG. 4

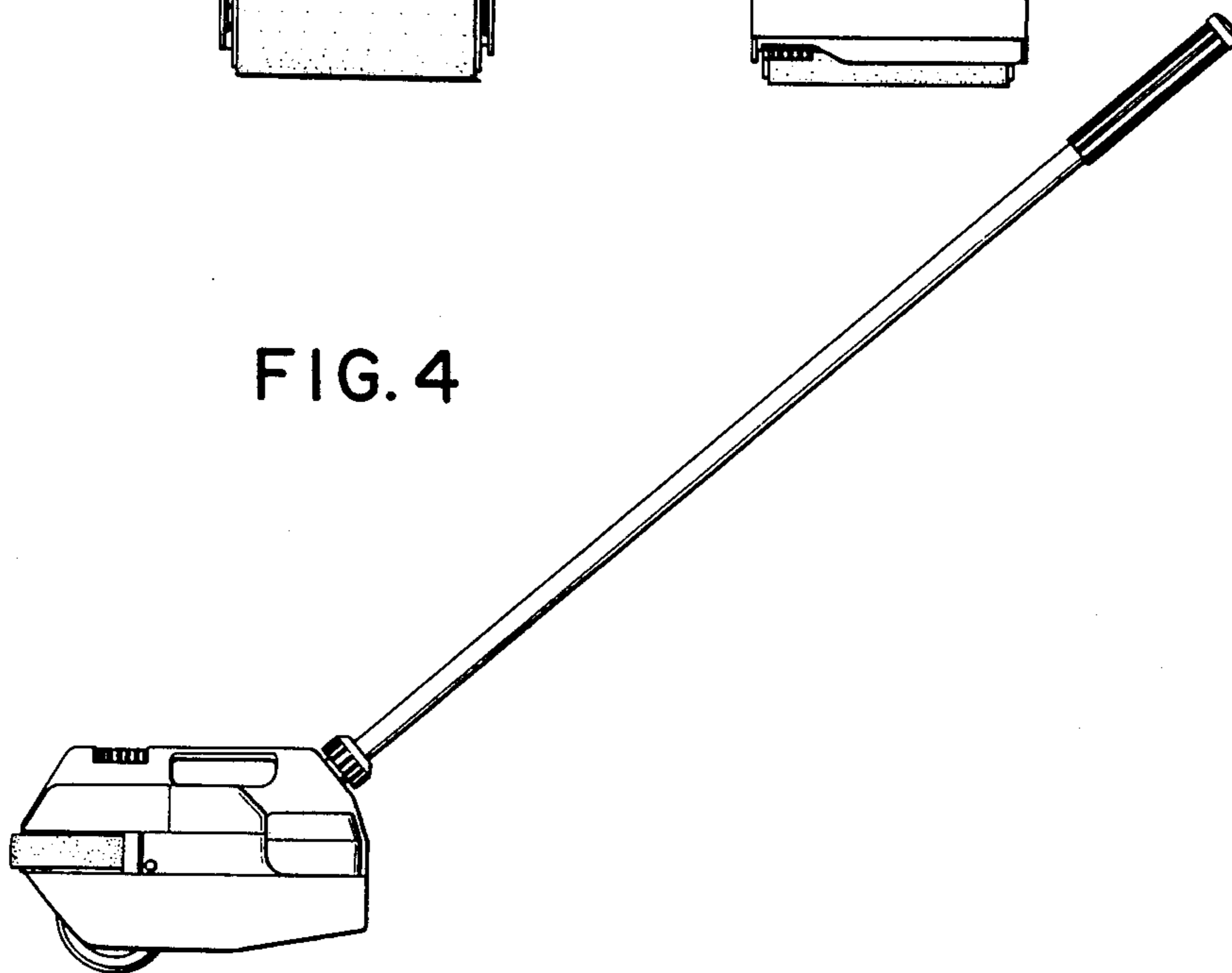

FIG. 7

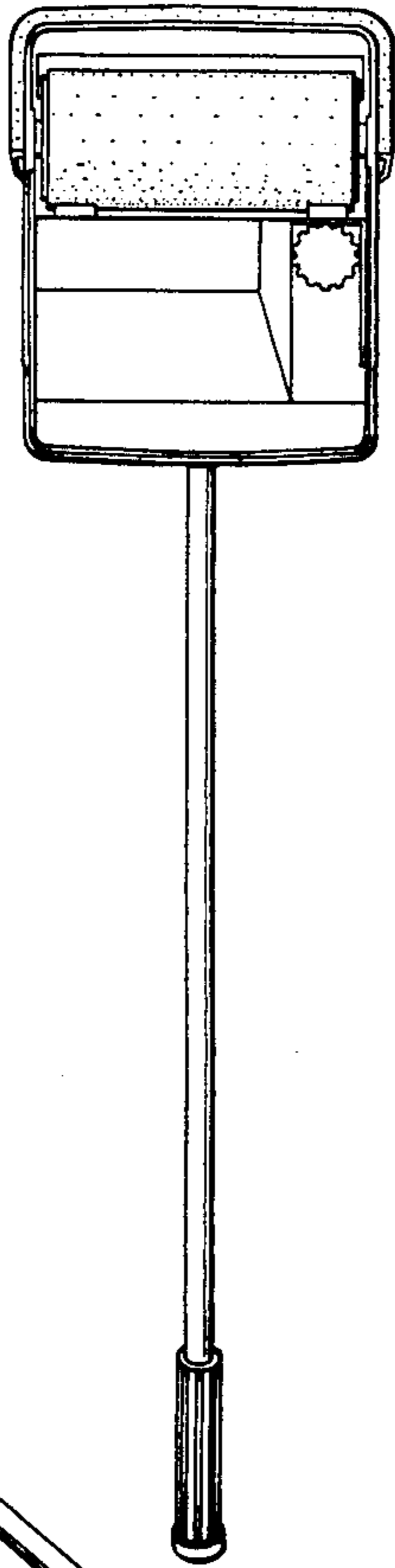

FIG. 6

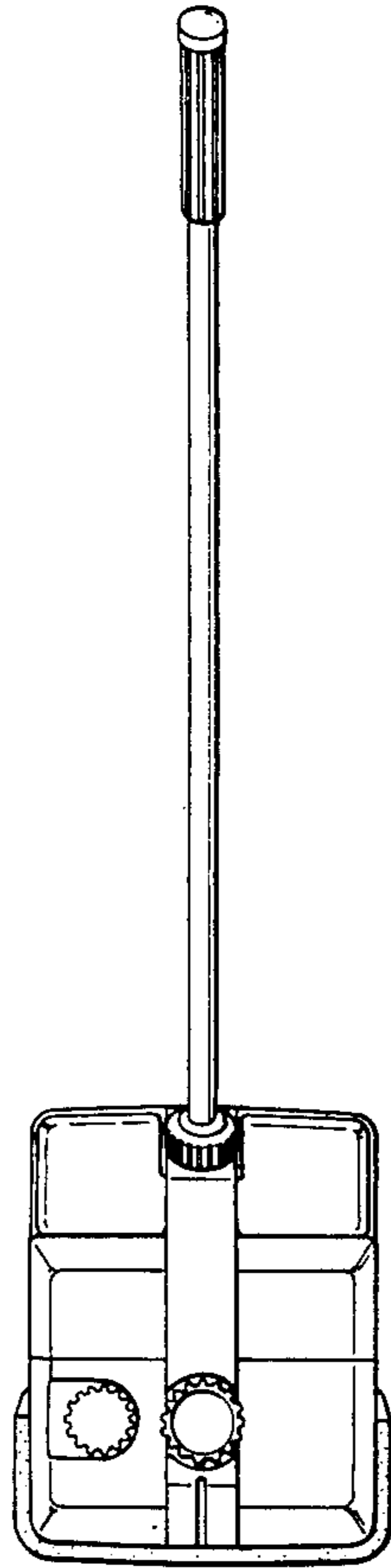

FIG. 5

