

[54] **FOOD PROCESSOR**

[76] Inventor: **Monte L. Levin**, 16 Sutton Pl., New York, N.Y. 10022

[**] Term: **14 Years**

[21] Appl. No.: **866,468**

[22] Filed: **Dec. 30, 1977**

[51] Int. Cl. **D7-04**

[52] U.S. Cl. **D7/154; D7/155; D7/159**

[58] Field of Search **D7/159, 158, 157, 156, D7/155, 154, 153; D15/98, 99, 92; 241/37.5, 92, 282.1, 282.2**

[56] **References Cited**

U.S. PATENT DOCUMENTS

D. 191,152 8/1961 Rawson, Jr. et al. **D7/154**

D. 201,116 5/1965 Häuptli **D7/155**

FOREIGN PATENT DOCUMENTS

314595 6/1956 Switzerland **241/92**

Primary Examiner—Donald B. Moyer
Attorney, Agent, or Firm—Dallett Hoopes

[57] **CLAIM**

The ornamental design for a food processor, substantially as shown.

DESCRIPTION

FIG. 1 is a front perspective view of a food processor showing my new design;

FIG. 2 is a front elevational view;

FIG. 3 is a top plan view;

FIG. 4 is a rear elevational view;

FIG. 5 is a right side elevational view; and

FIG. 6 is a left side elevational view.

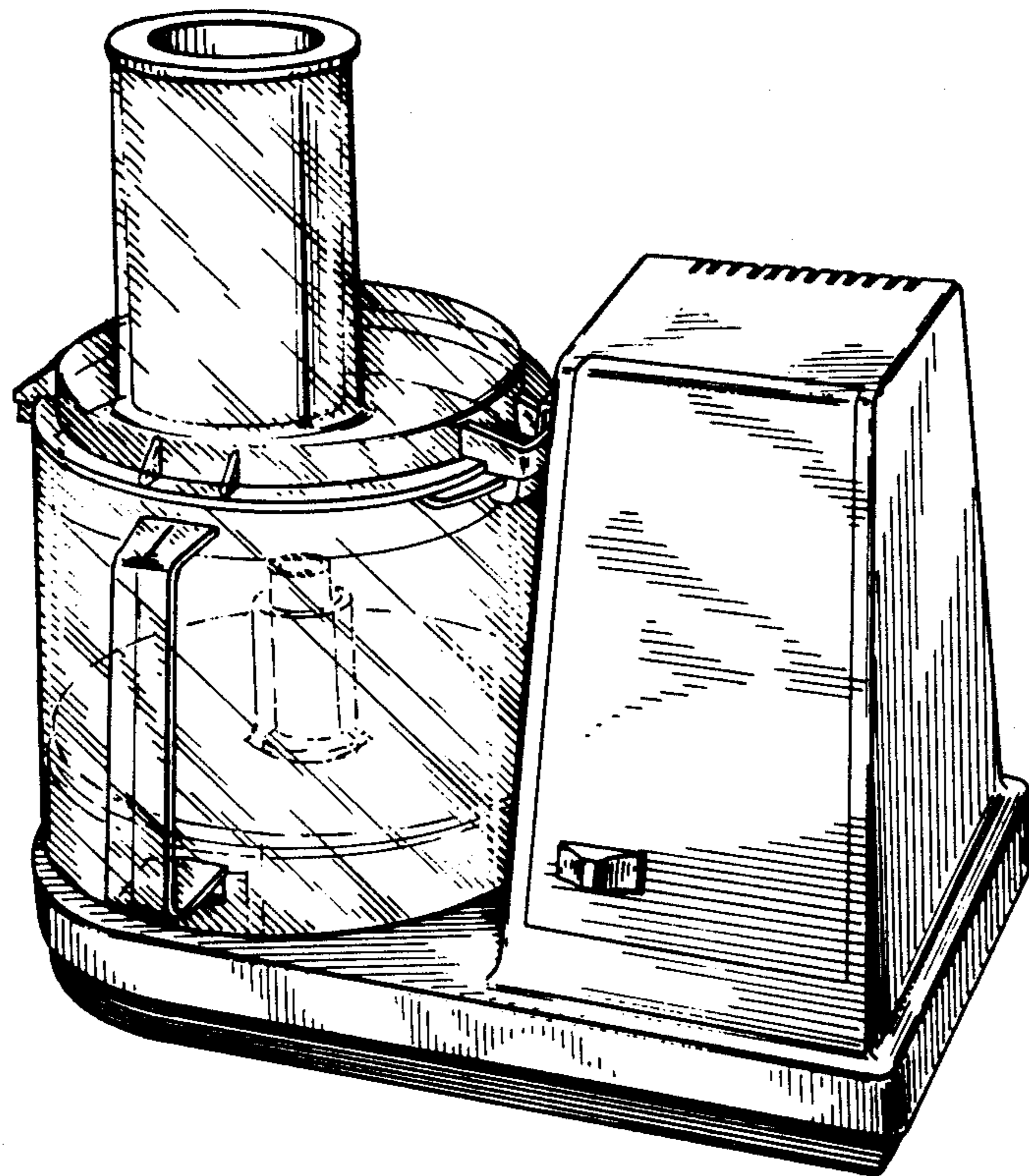

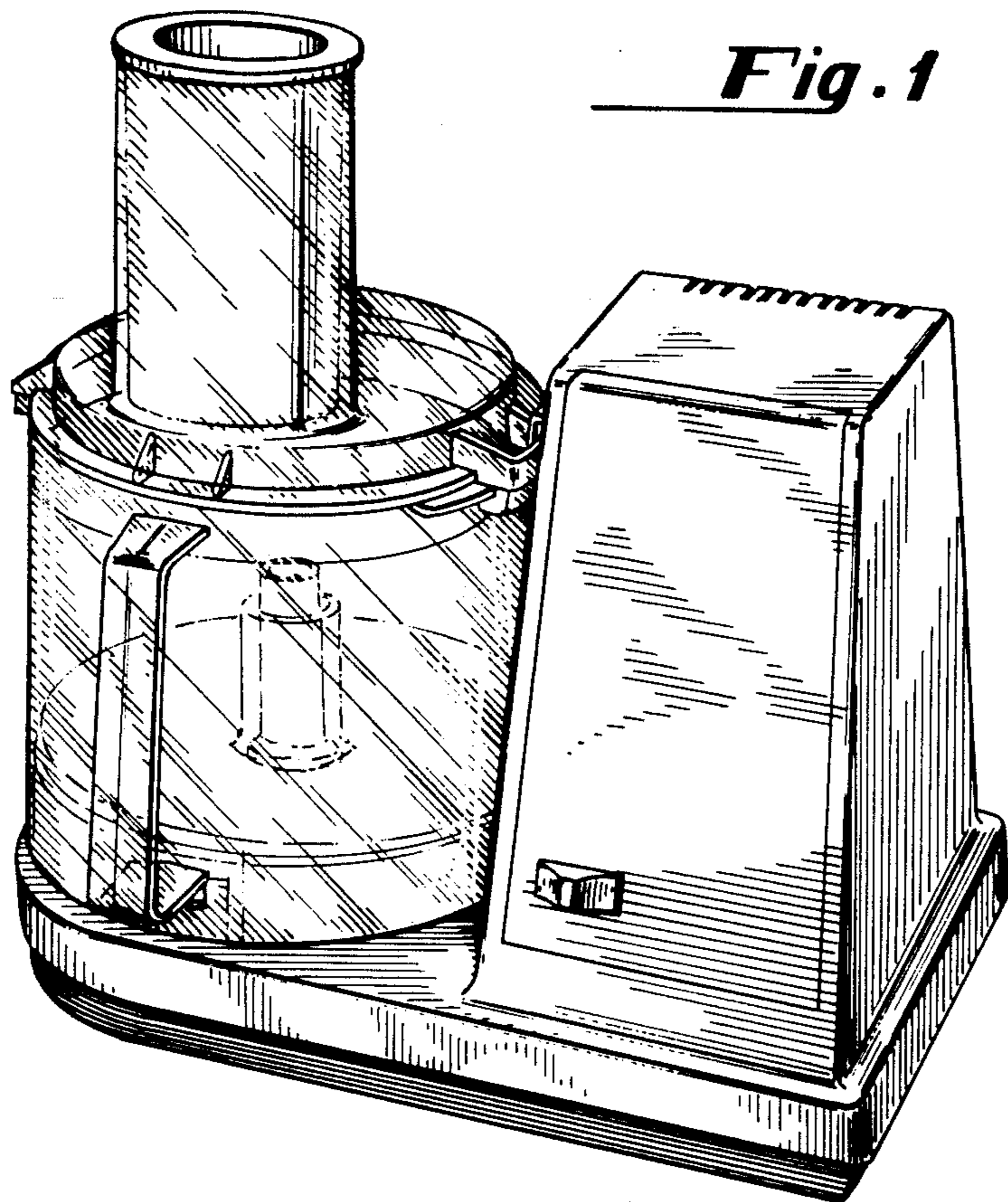

Fig. 1

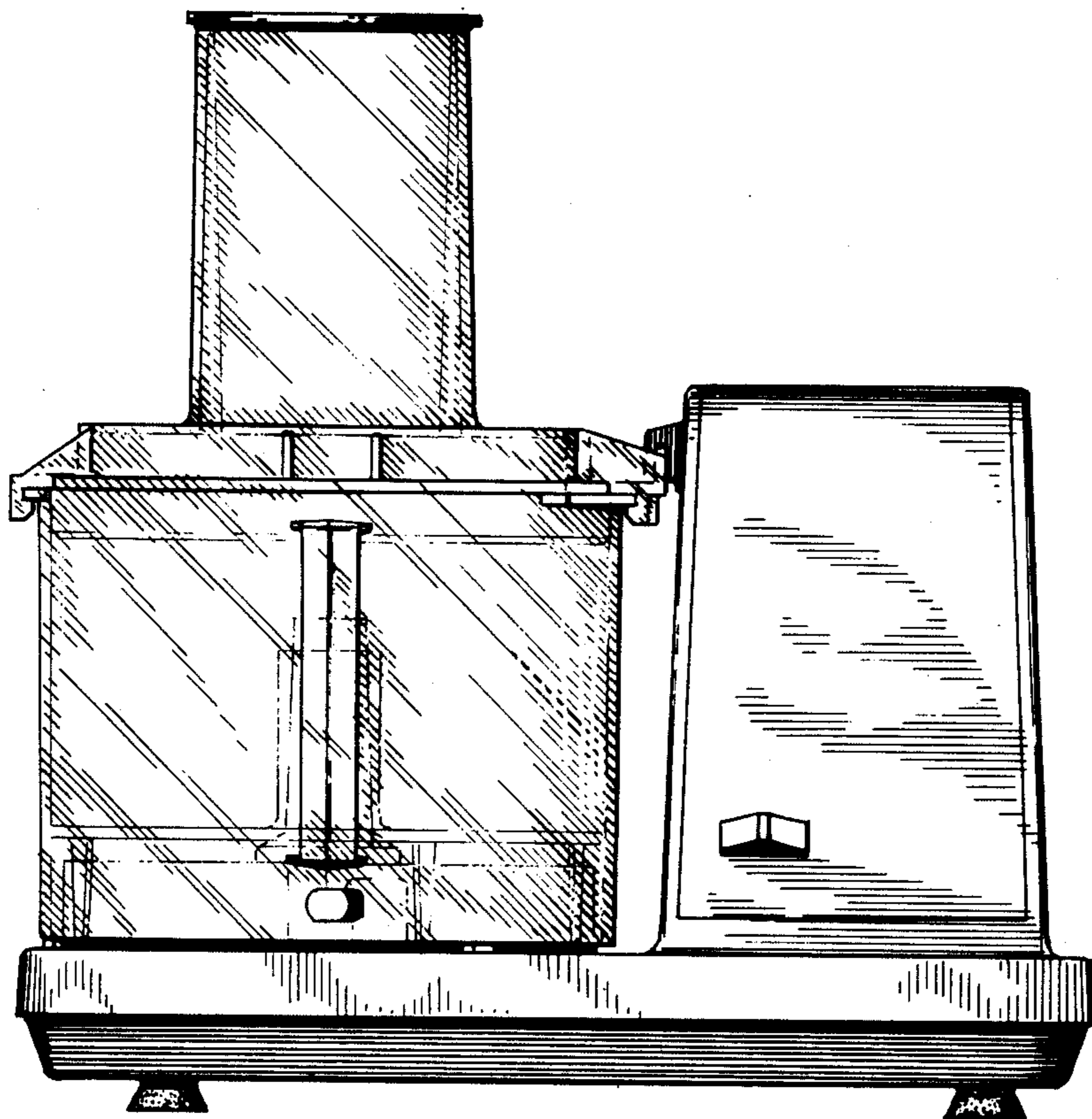

Fig. 2

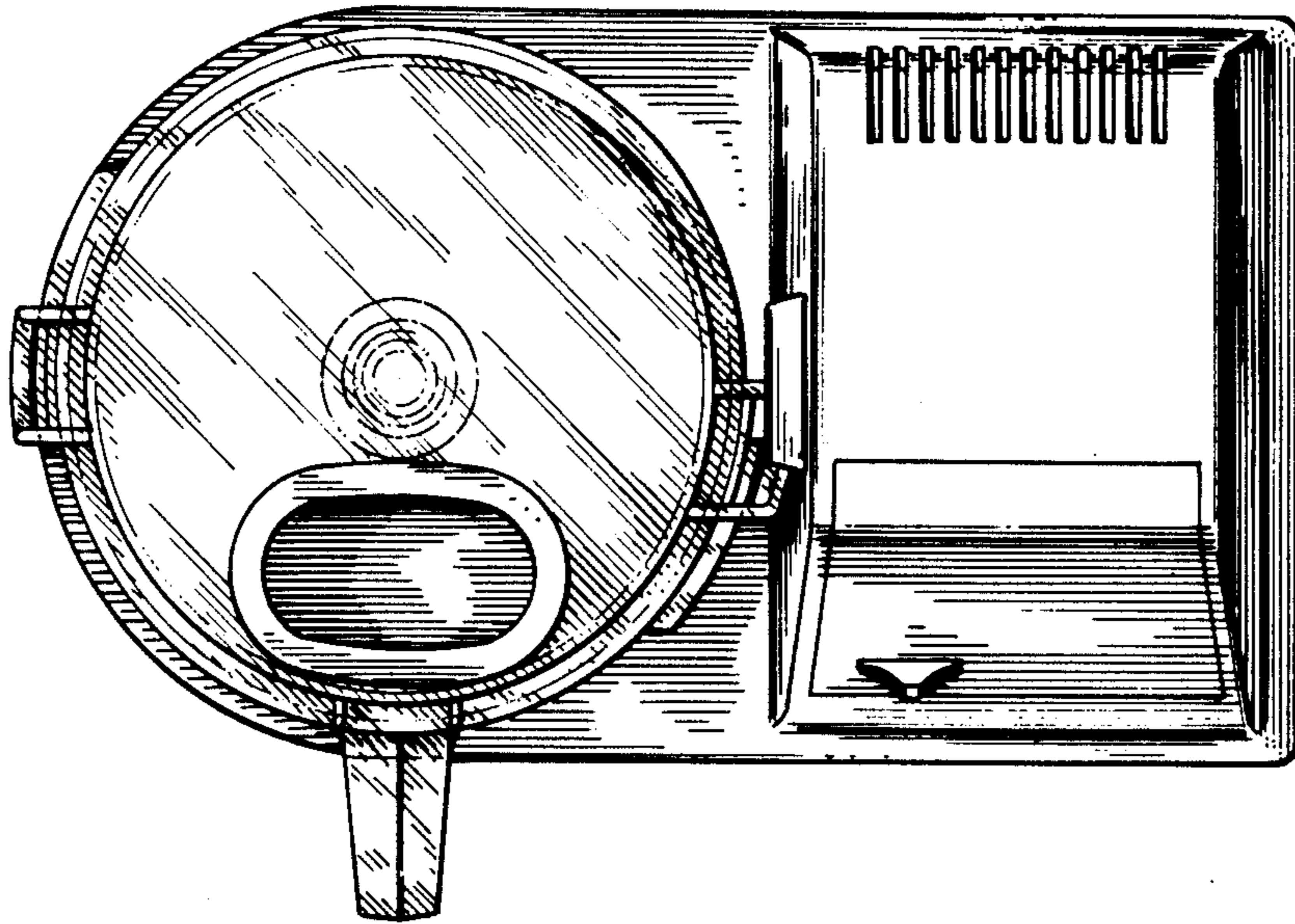

Fig. 3

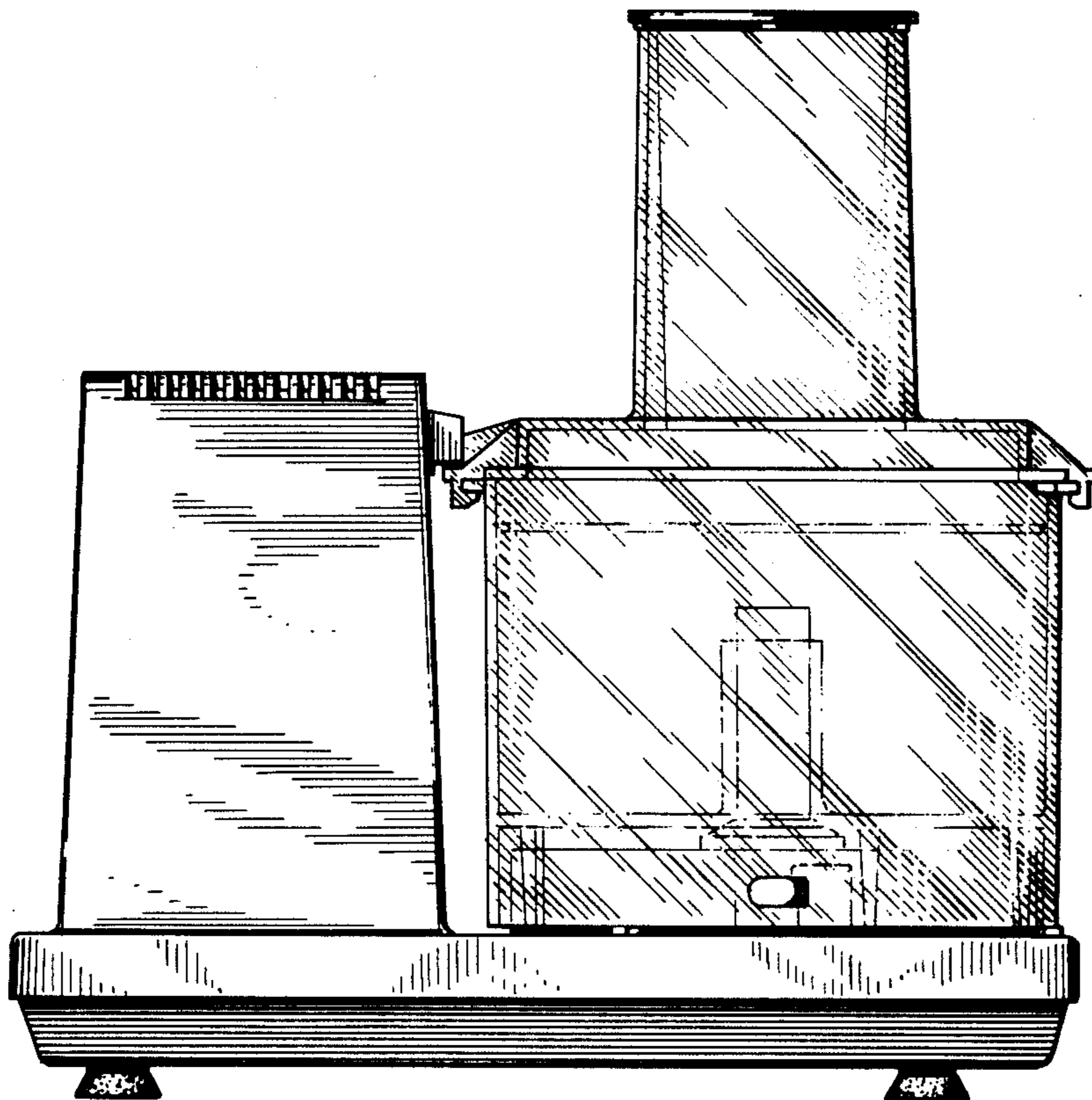

Fig. 4

Fig. 5

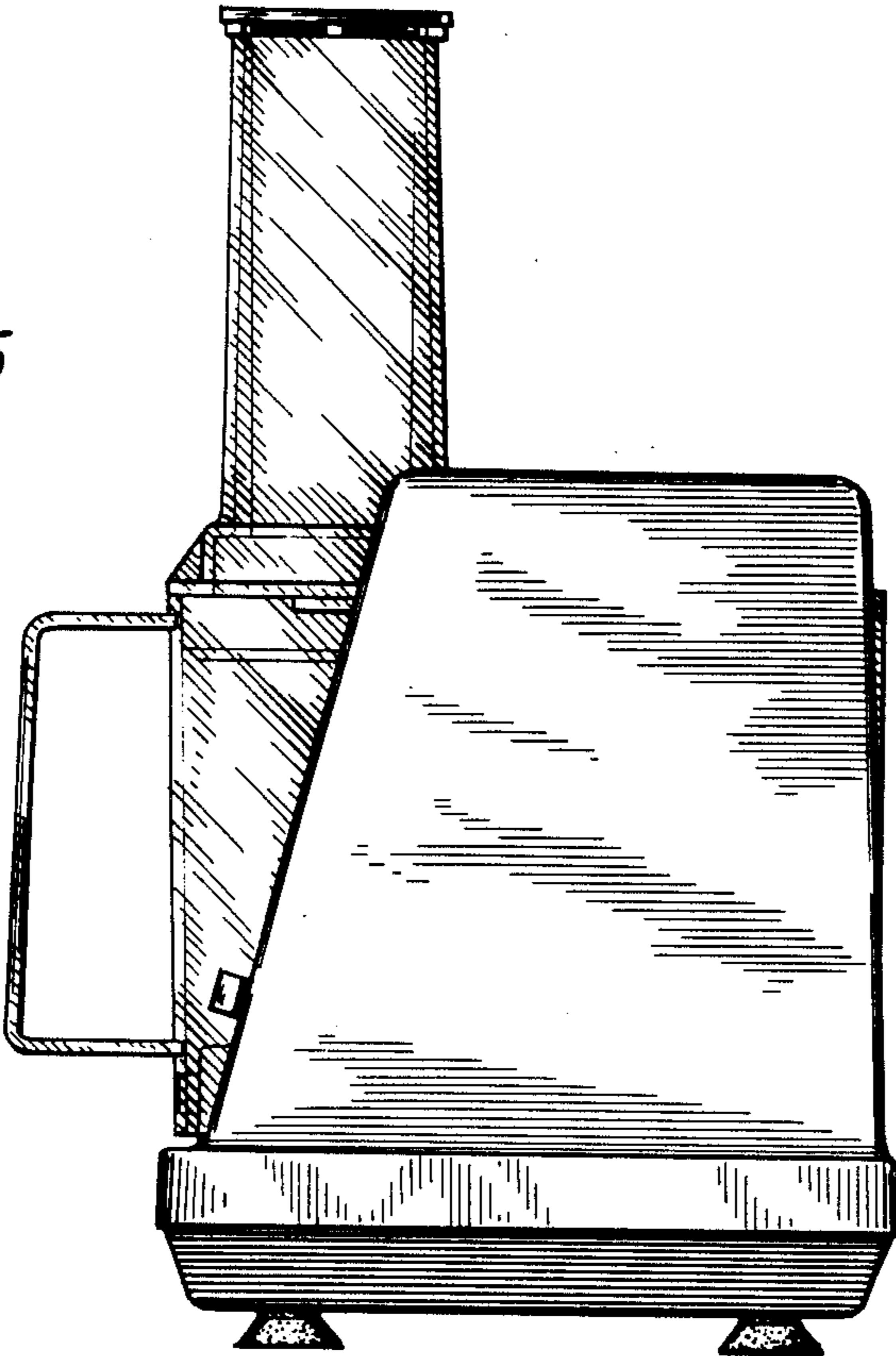
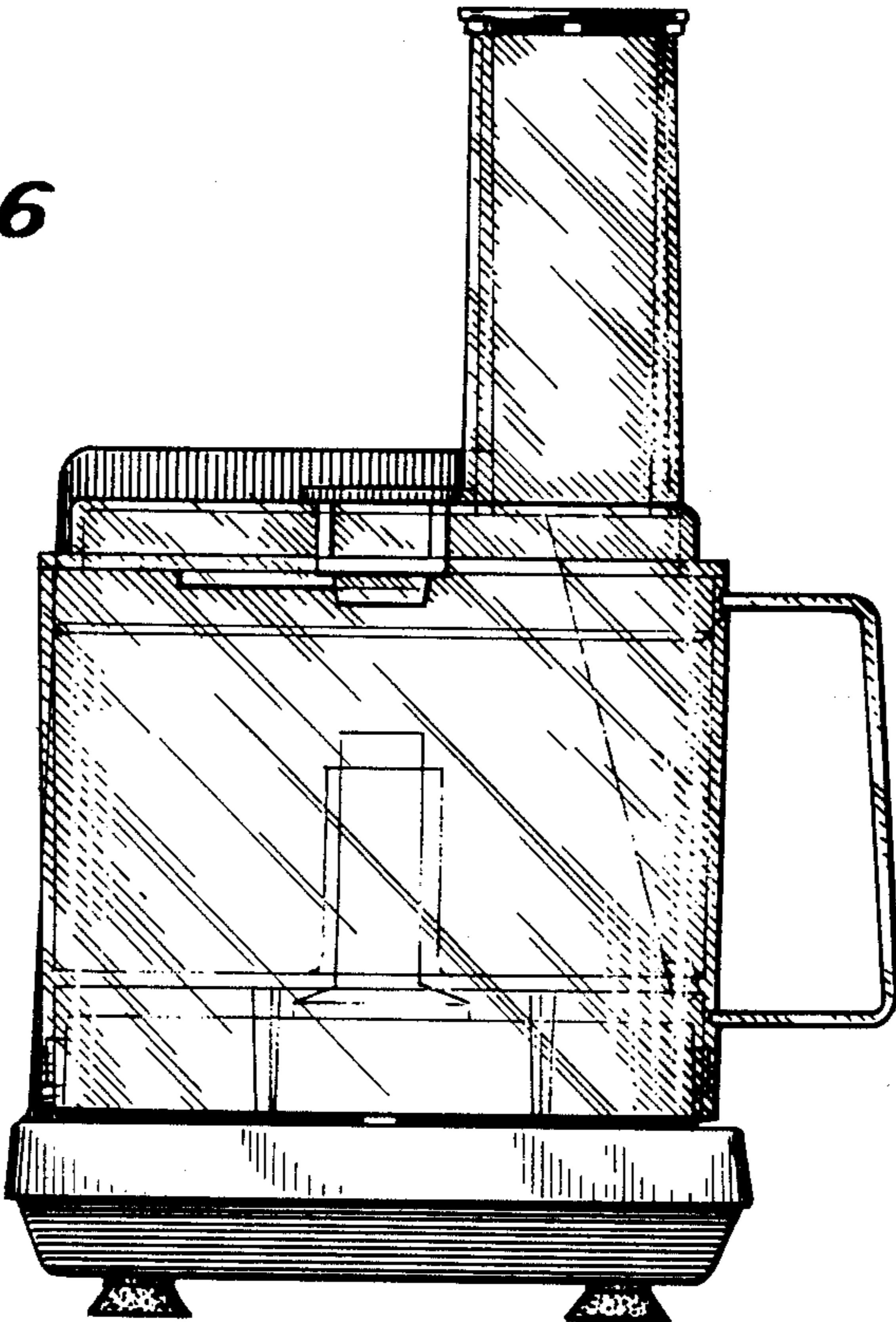

Fig. 6



UNITED STATES PATENT OFFICE
CERTIFICATE OF CORRECTION

Design
Patent No. 256,318 Dated August 12, 1980

Inventor(s) Monte L. Levin

It is certified that error appears in the above-identified patent and that said Letters Patent are hereby corrected as shown below:

Add the assignee of record to the face of the above-identified patent; namely,

(73) Assignee: Scovill Manufacturing Company
Waterbury, Conn.

Signed and Sealed this

Seventeenth Day of March 1981

[SEAL]

Attest:

RENE D. TEGTMEYER

Attesting Officer

Acting Commissioner of Patents and Trademarks