

[54] RIDING TOY

[75] Inventor: Edward B. Bretschger, Cos Cob, Conn.

[73] Assignee: Louis Marx & Co., Inc., Stamford, Conn.

[**] Term: 14 Years

[21] Appl. No.: 876,791

[22] Filed: Feb. 10, 1978

[51] Int. Cl. D21-01

[52] U.S. Cl. D21/74

[58] Field of Search D21/128, 136, 141, 74,
D21/76, 80, 157; 280/1.1 R, 1.11 R, 1.13, 1.22,
87.01; D12/83, 108, 112, 113

[56]

References Cited

U.S. PATENT DOCUMENTS

D. 70,698	7/1926	Lusse et al.	D21/78
D. 190,037	4/1961	Pressner	D21/74
D. 228,400	9/1973	Novak	D21/74
D. 237,520	11/1975	Satten	D21/74

Primary Examiner—Charles A. Rademaker
Attorney, Agent, or Firm—Blum, Kaplan, Friedman,
Silberman & Beran

[57]

CLAIM

The ornamental design for a riding toy, as shown.

DESCRIPTION

FIG. 1 is a perspective view of a riding toy showing my new design;

FIG. 2 is a top plan view thereof;

FIG. 3 is an elevational view of the side opposite that shown in FIG. 1;

FIG. 4 is a front elevational view thereof;

FIG. 5 is a rear elevational view thereof; and

FIG. 6 is a bottom plan view thereof.

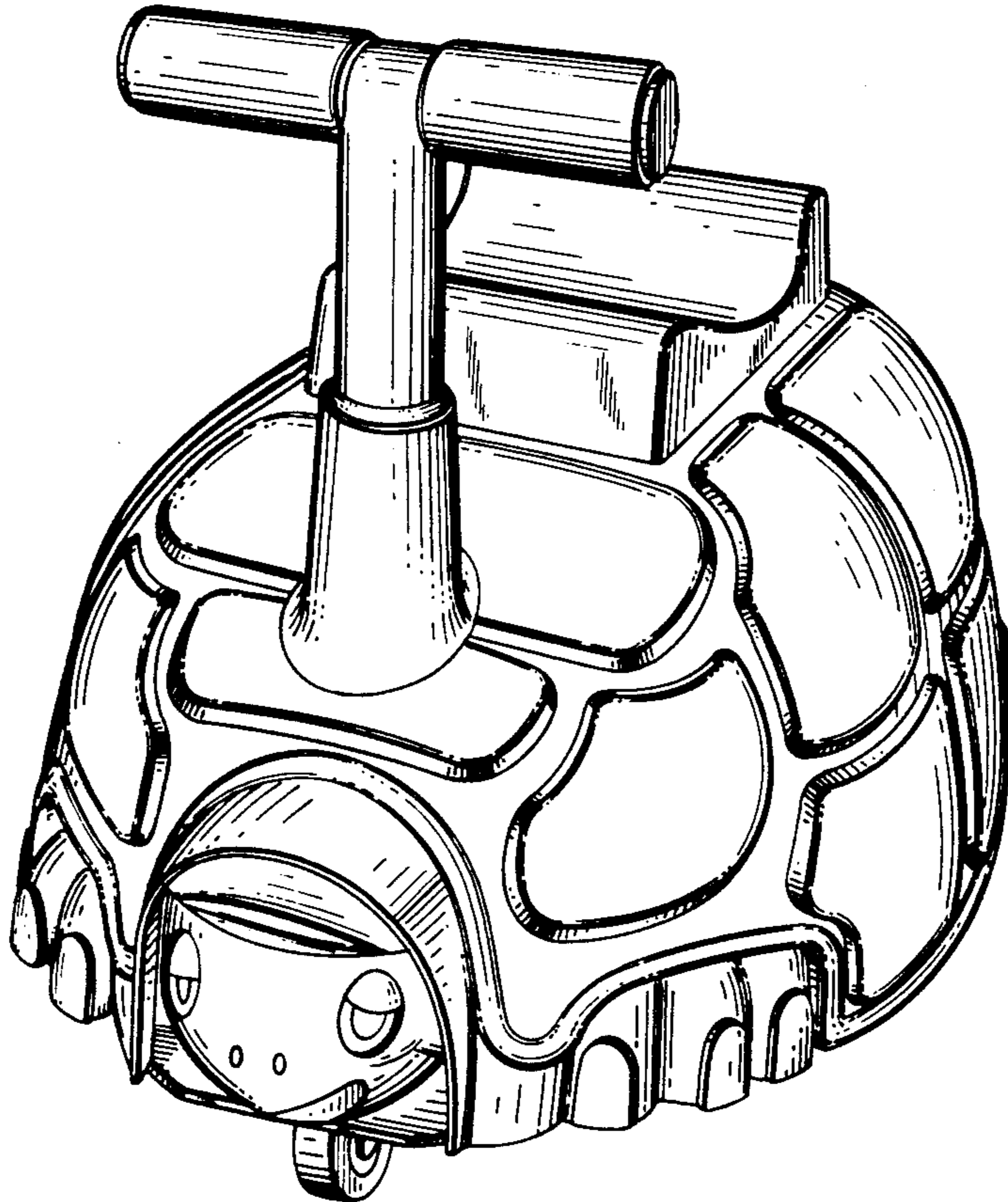

FIG. 1

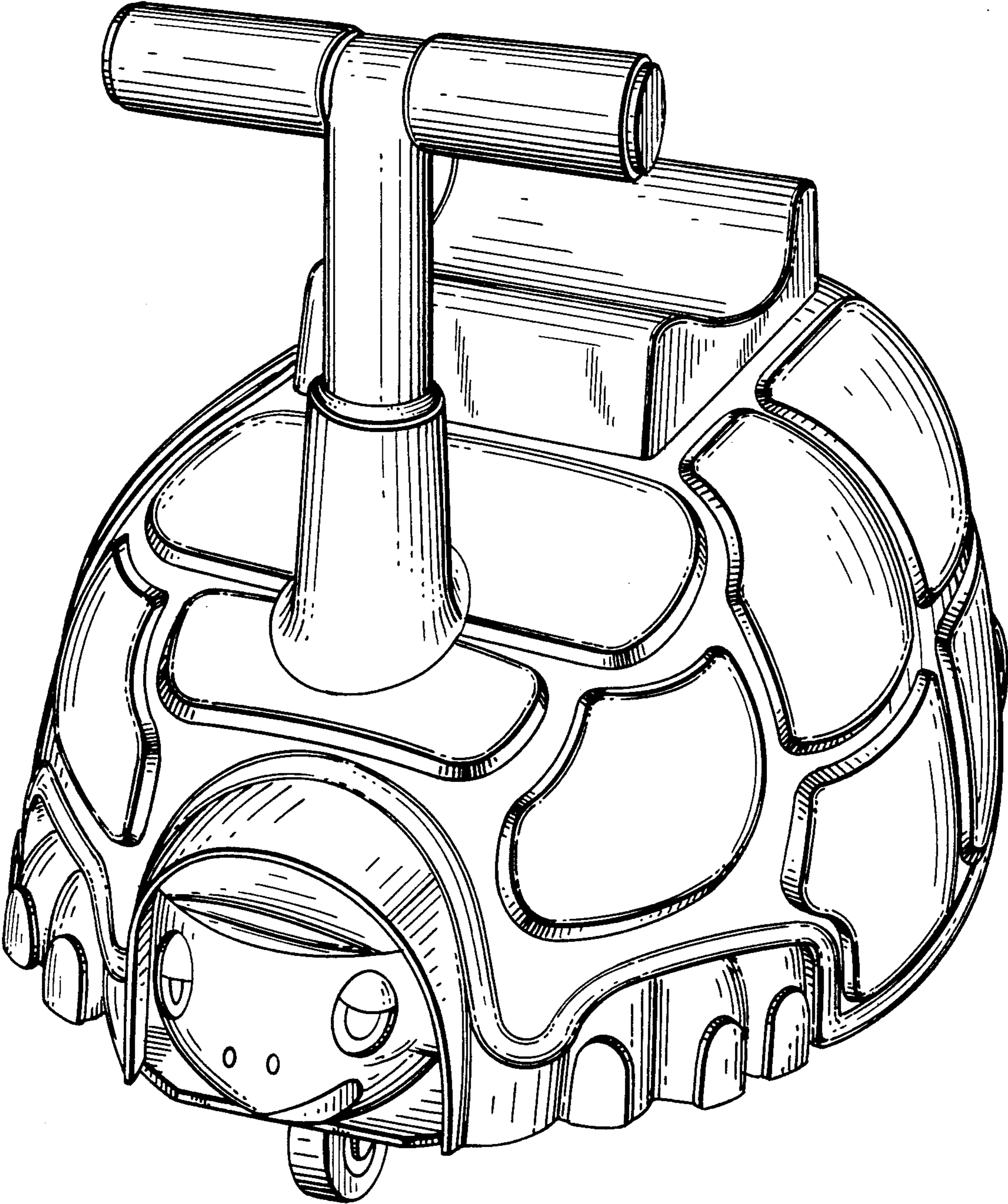

FIG. 2

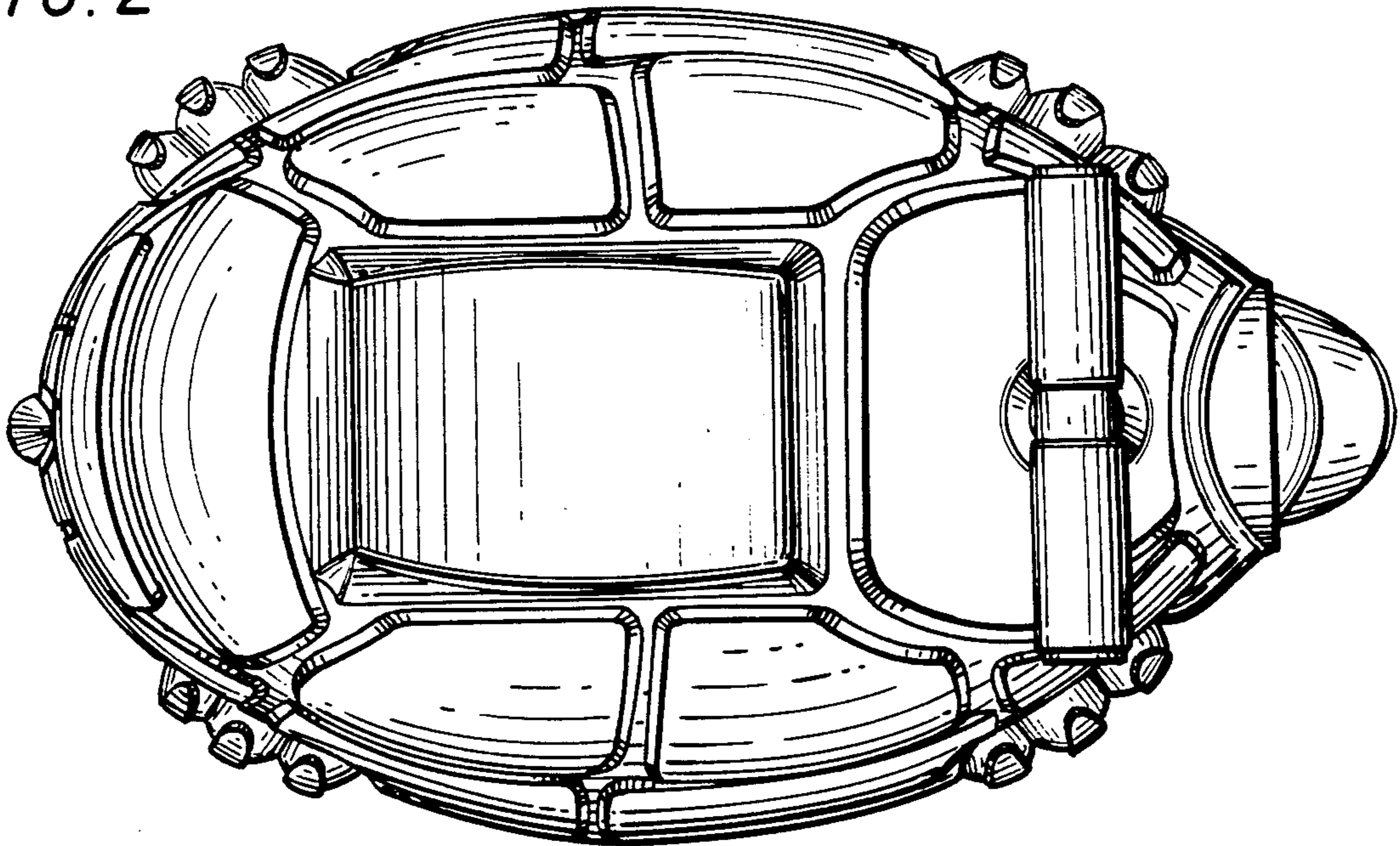

FIG. 3

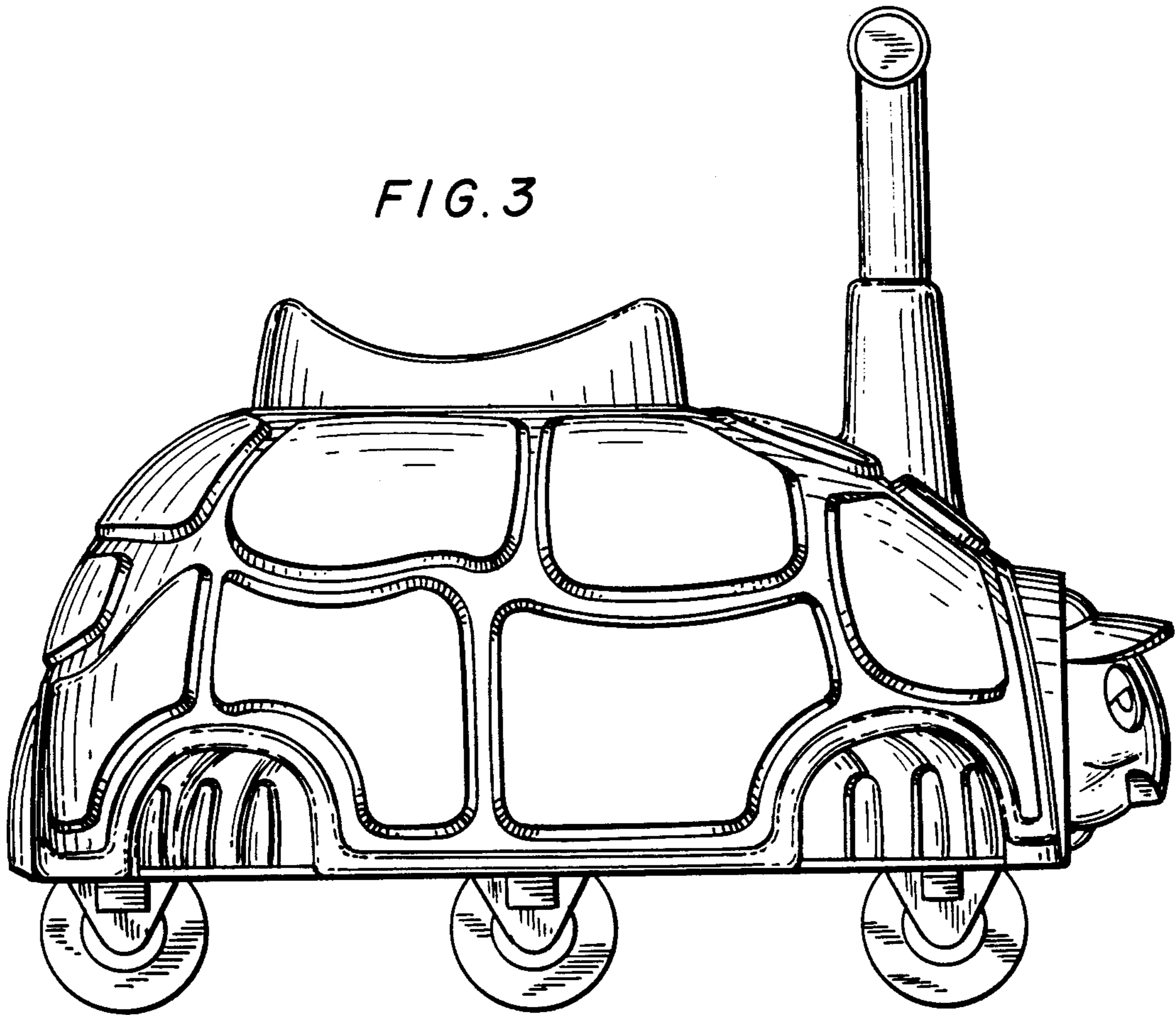

FIG. 5

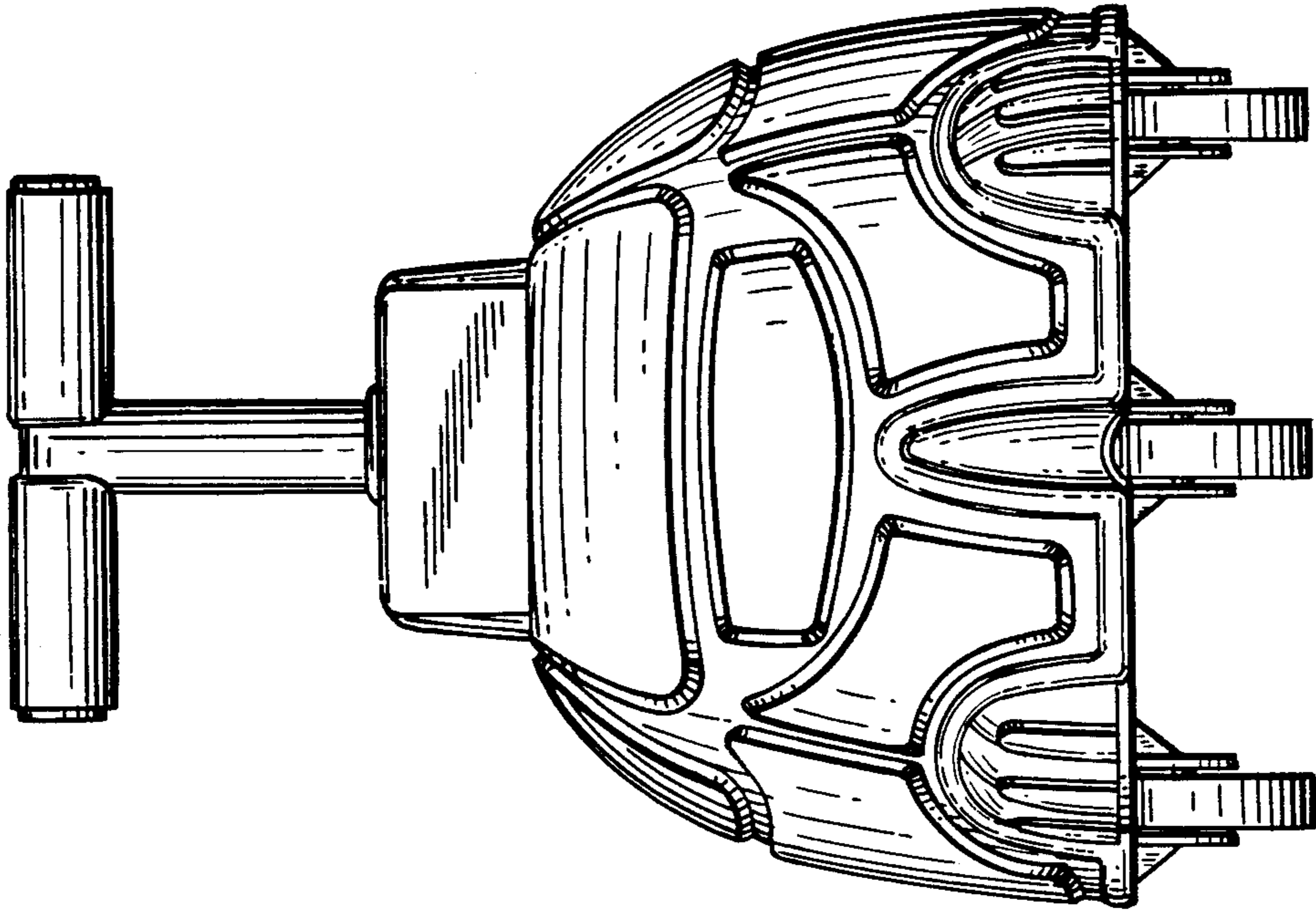
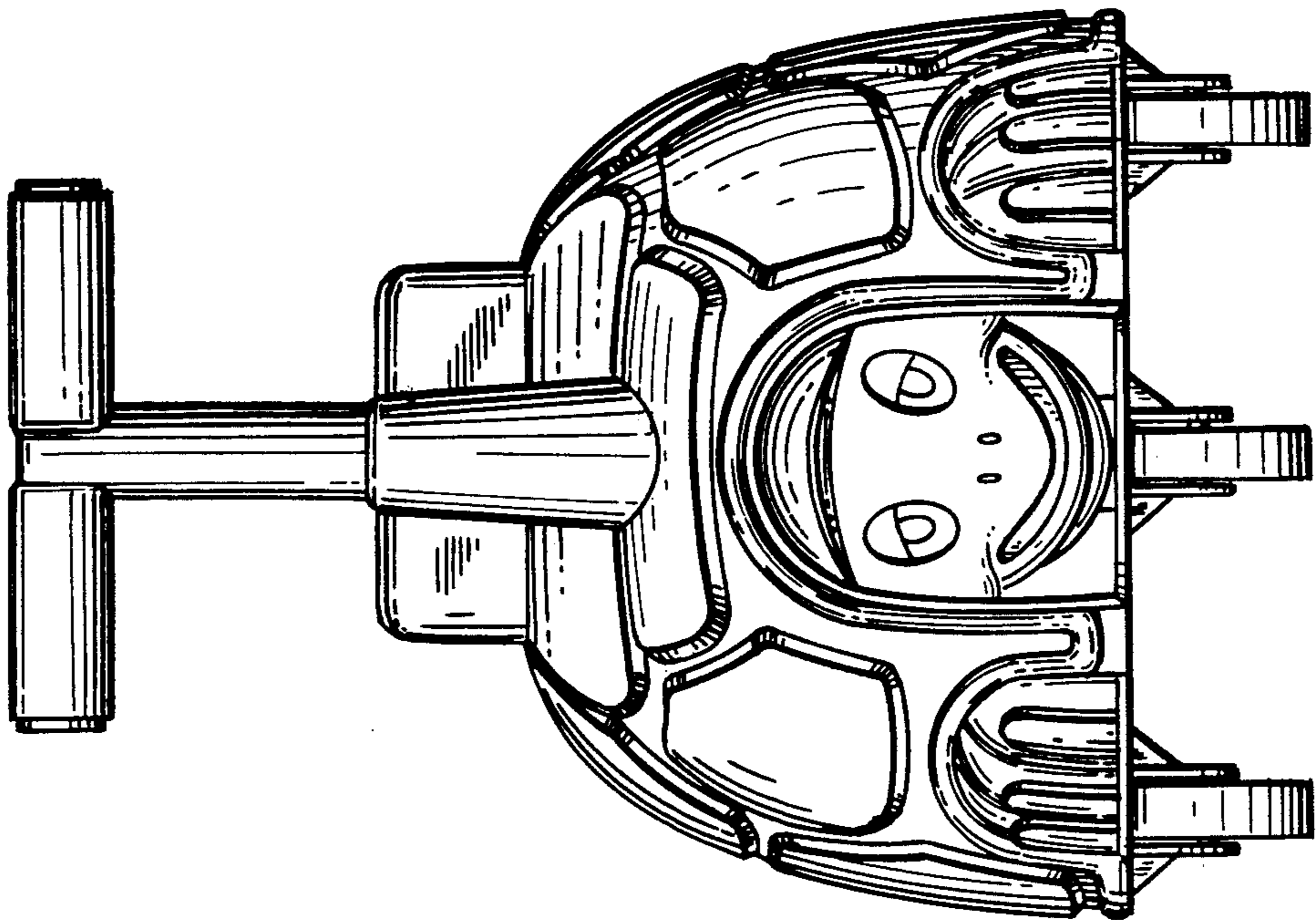

FIG. 4



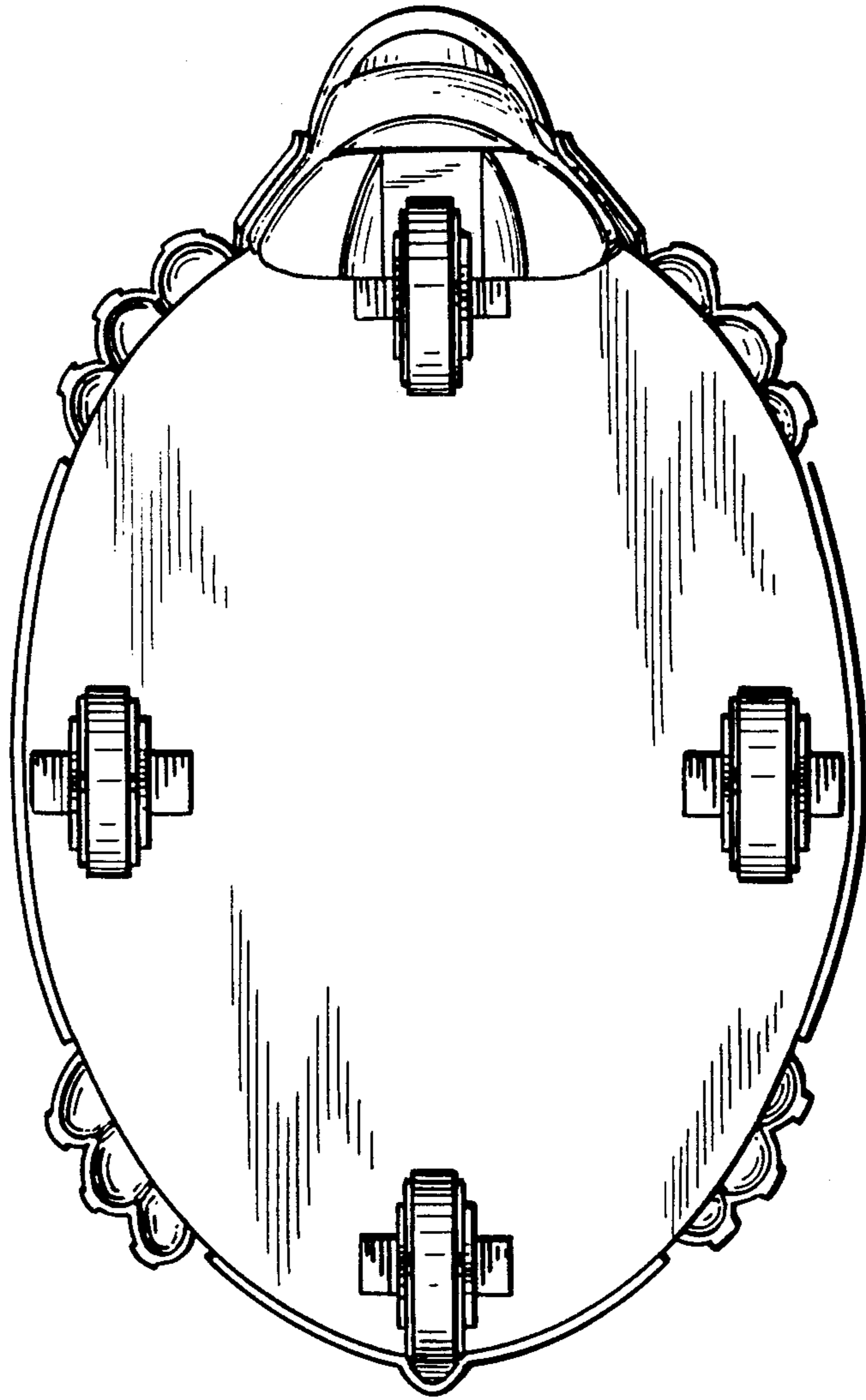

FIG. 6