

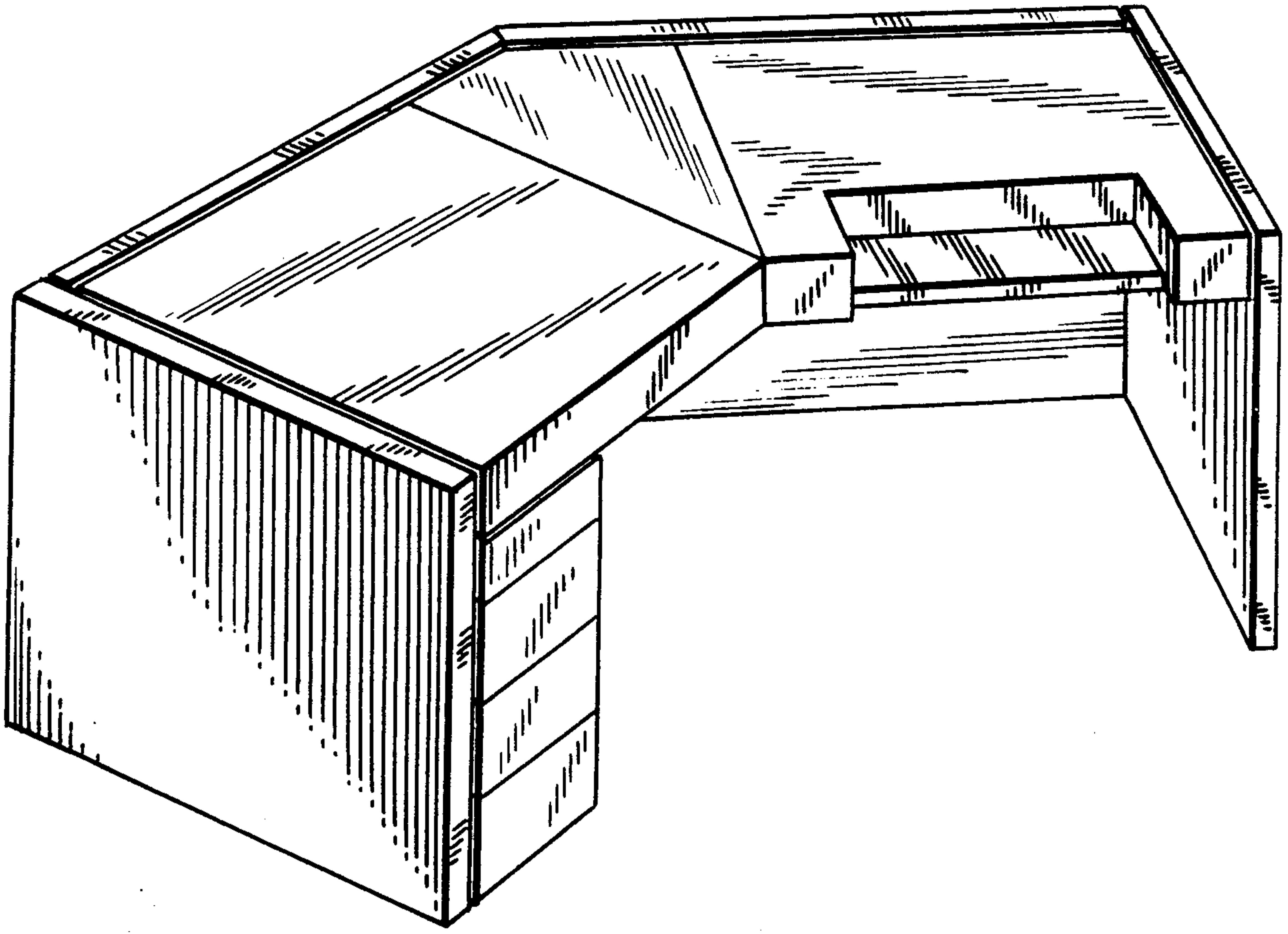
[54] STATION  
[76] Inventor: Frank Gayeski, 45 Pine St.,  
Hackensack, N.J. 07601  
[\*\*] Term: 14 Years  
[21] Appl. No.: 897,922  
[22] Filed: Apr. 19, 1978  
[51] Int. Cl. .... D6-04  
[52] U.S. Cl. .... D6/161; D6/162  
[58] Field of Search ..... D6/161, 162; 312/194,  
312/195, 196

[56] **References Cited**  
**U.S. PATENT DOCUMENTS**  
D. 186,369 10/1959 Lintereur ..... D6/162 X  
D. 186,894 12/1959 Henrikson et al. .... D6/161  
D. 223,046 2/1972 Nance ..... D6/162  
D. 235,952 7/1975 Ball ..... D6/162  
D. 239,227 3/1976 Vogt ..... D6/196 X  
1,293,952 2/1919 Shirley ..... D6/161 X  
2,793,926 5/1957 Deaton ..... 312/194

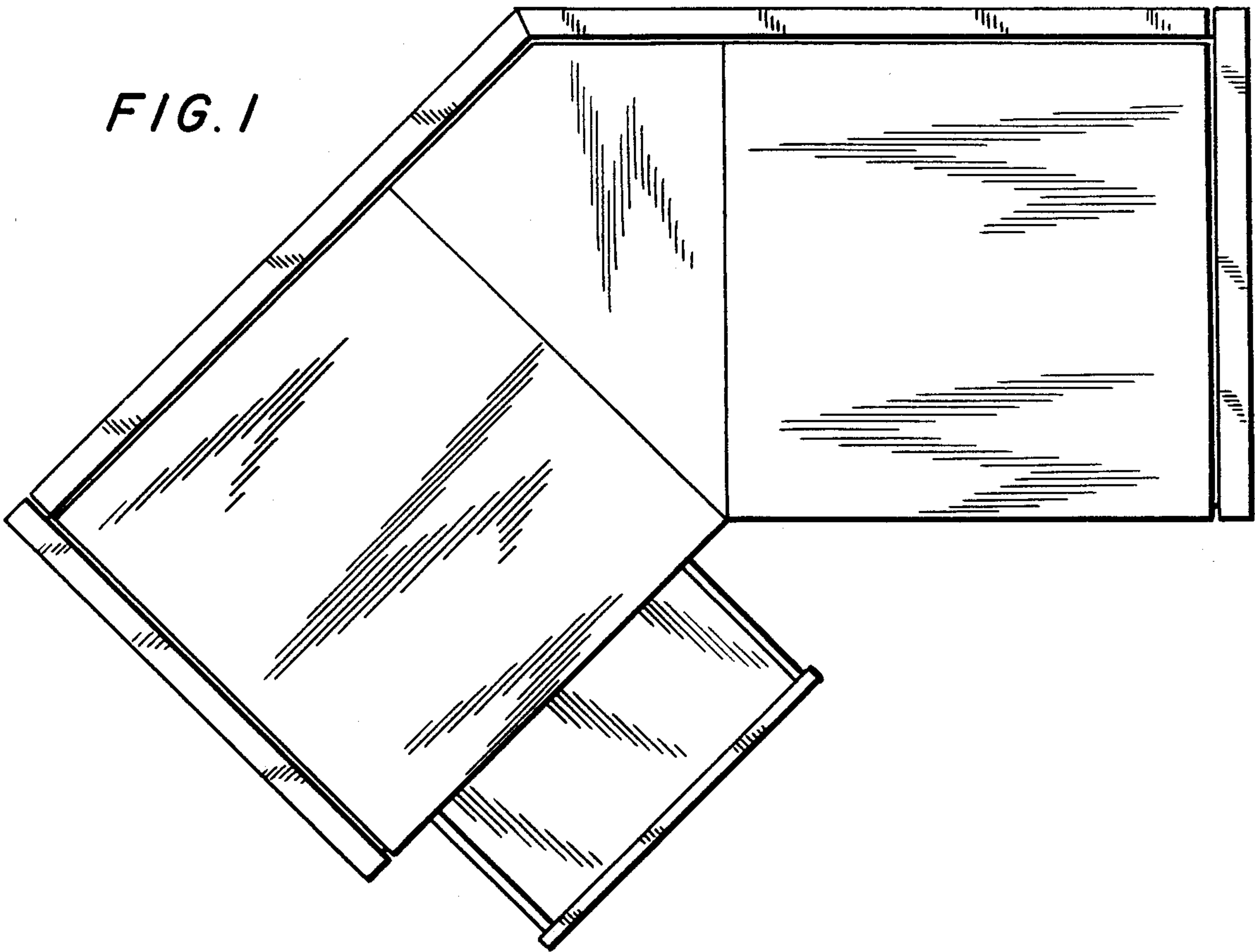
**OTHER PUBLICATIONS**  
Office Appliances, 11-1954, p. 78 "Typewriting Table".  
Primary Examiner—Bruce W. Dunkins

Attorney, Agent, or Firm—George Gottlieb  
[57] **CLAIM**  
The ornamental design for a station, as shown and described.

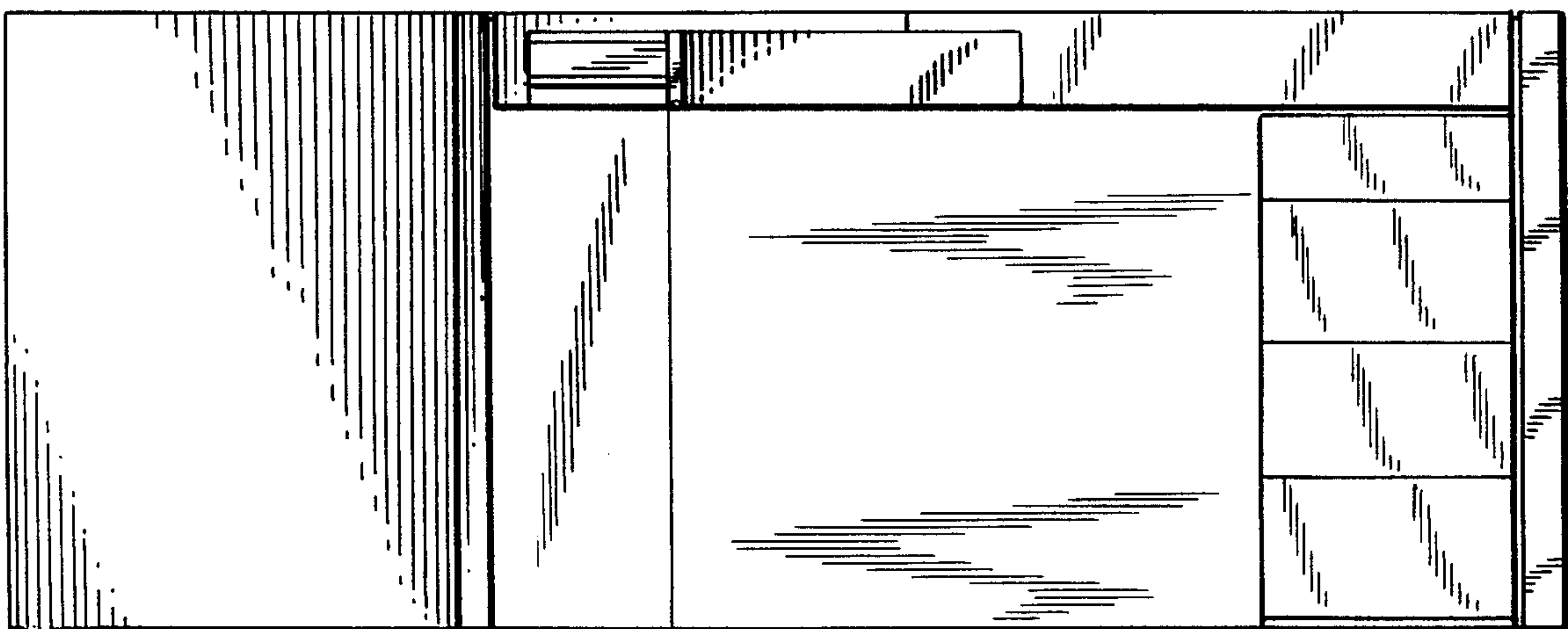
**DESCRIPTION**  
FIG. 1 is a top plan view of a station showing my new design;  
FIG. 2 is a front view of a station showing my new design;  
FIG. 3 is a left side view of a station showing my new design;  
FIG. 4 is a rear view of a station showing my new design;  
FIG. 5 is a right side view of a station showing my new design;  
FIG. 6 is a bottom plan view of a station showing my new design;  
FIG. 7 is a perspective view of a station showing an alternate embodiment of my new design; and  
FIG. 8 is a perspective view of a station showing a further embodiment of my new design; and  
FIG. 9 is a perspective view of a station showing still another embodiment of my new design.  
One of the drawers has been shown in partially open position in FIGS. 1, 2, 3, 5 and 6.



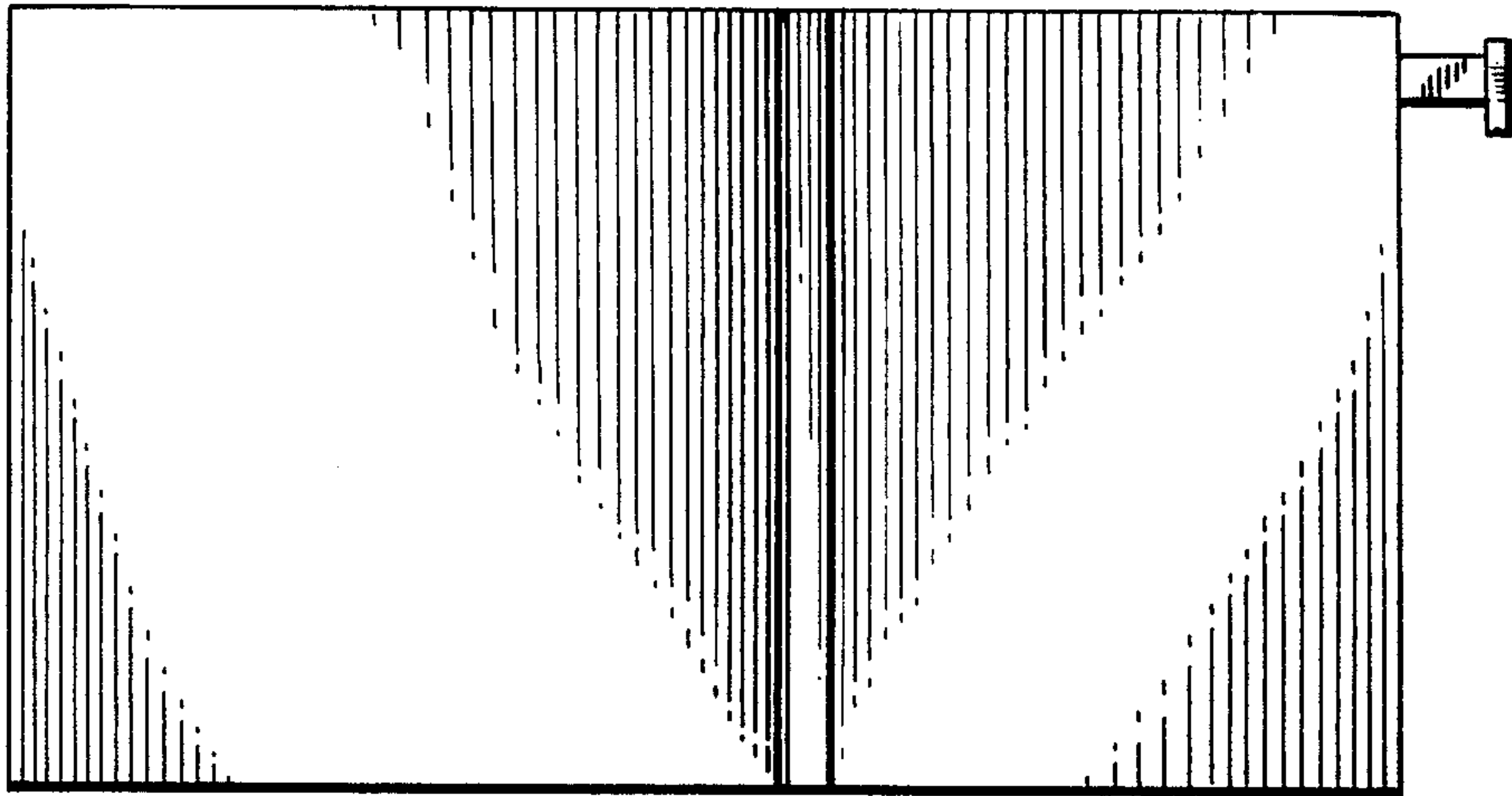
*FIG. 1*



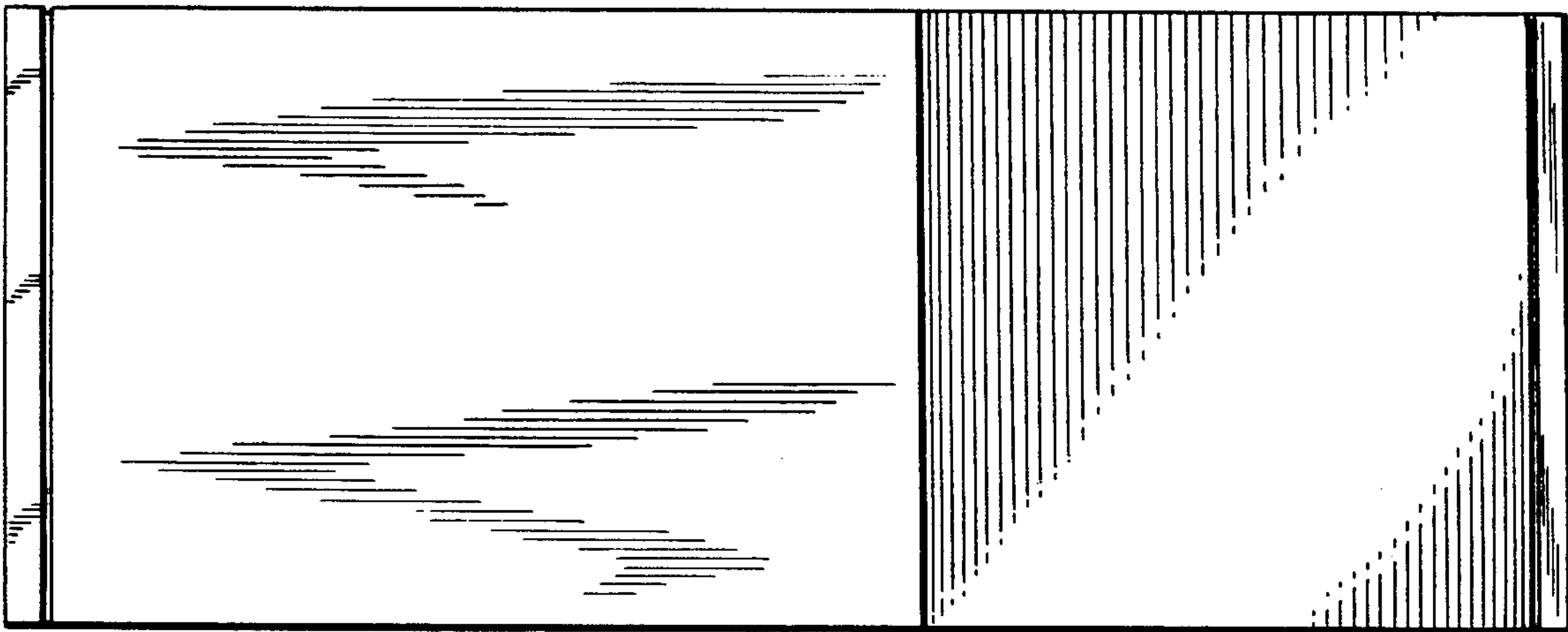
*FIG. 2*



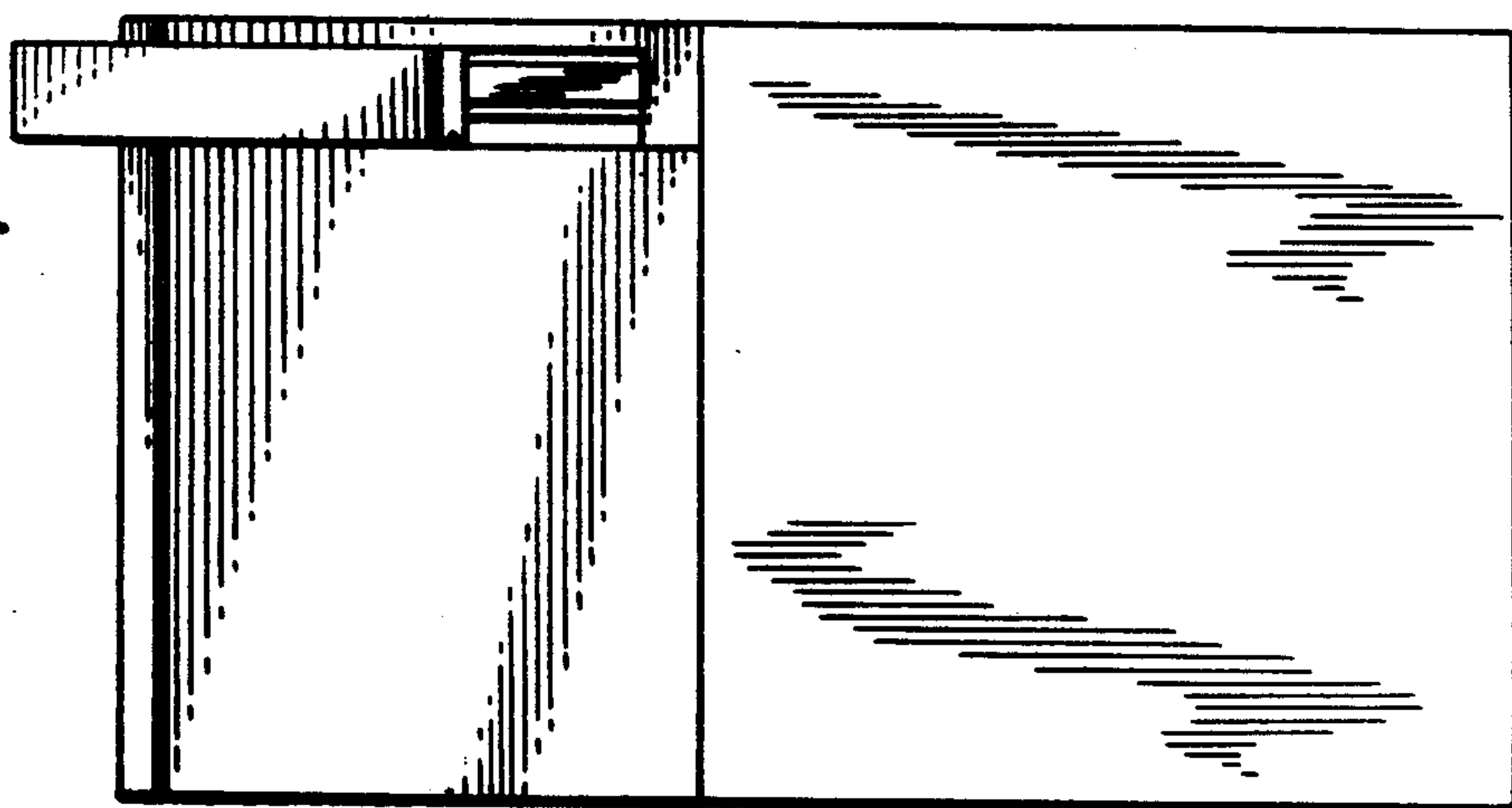
*FIG. 3*



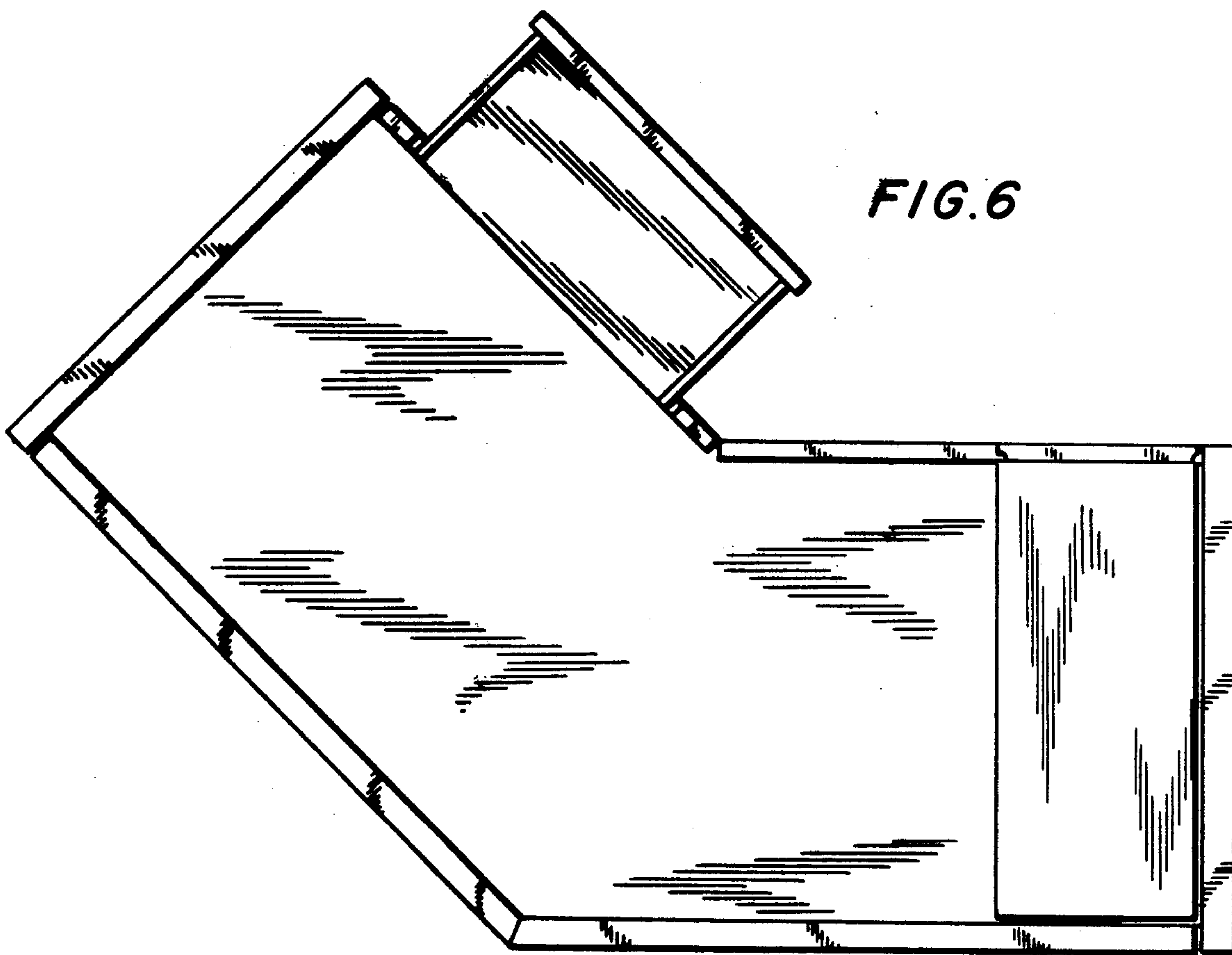
*FIG. 4*



**FIG. 5**

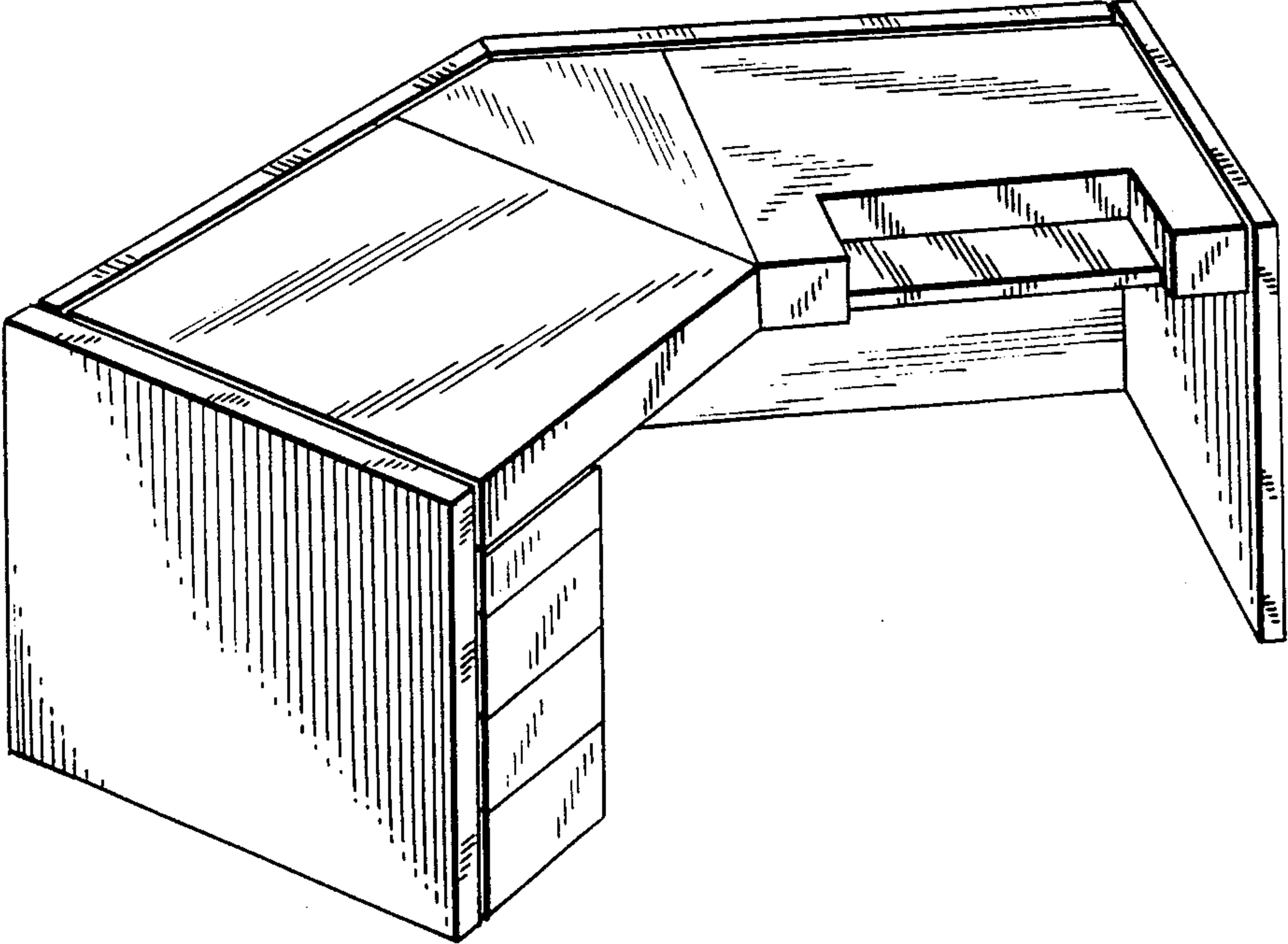


**FIG. 6**

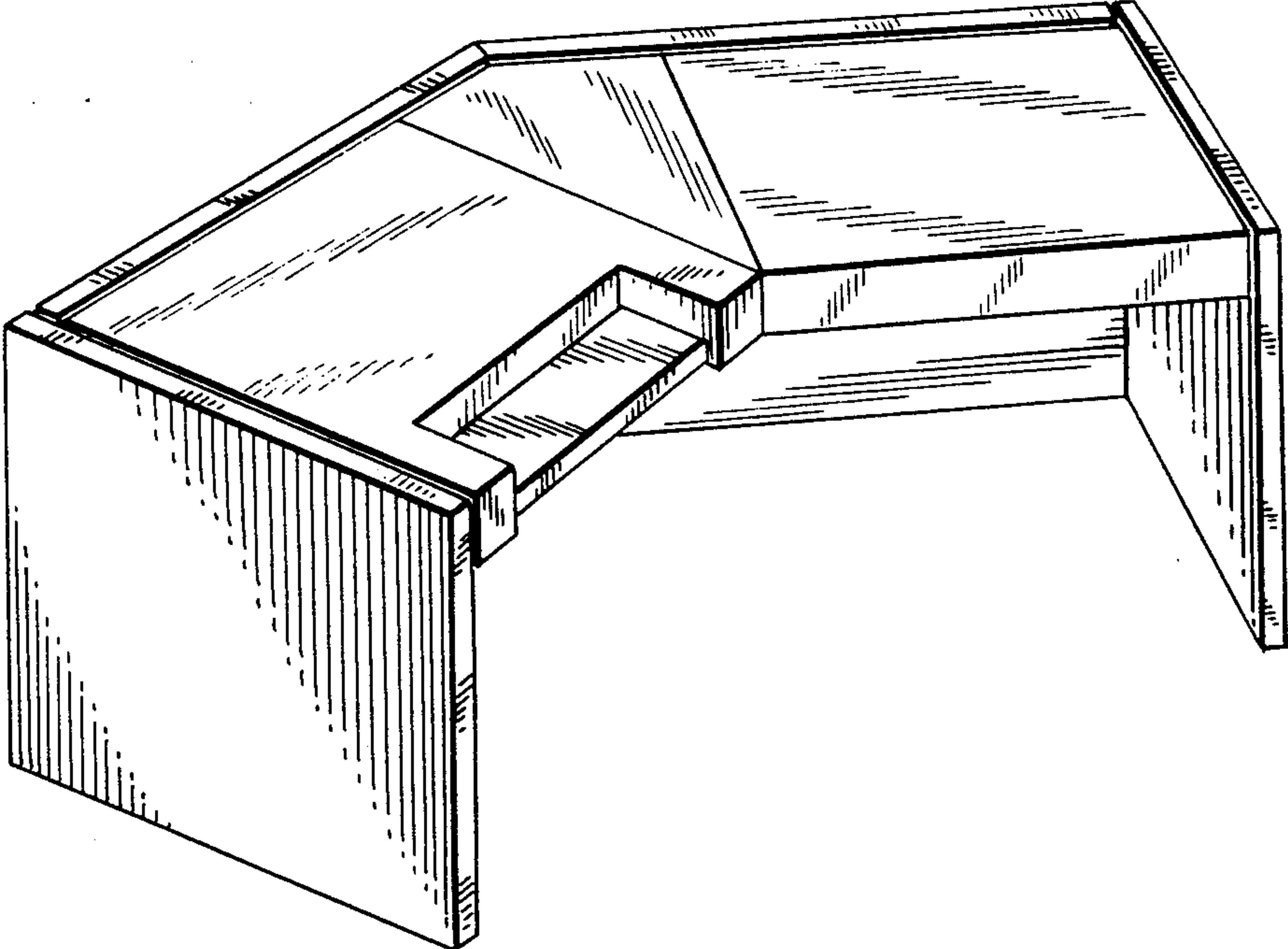




*FIG. 7*



*FIG. 8*



*FIG. 9*

