

[54] HUMIDIFIER

[75] Inventor: Masao Chihara, Matsudo, Japan
[73] Assignee: TDK Electronics Co., Ltd., Tokyo, Japan
[**] Term: 14 Years

[21] Appl. No.: 884,026
[22] Filed: Mar. 6, 1978

[30] Foreign Application Priority Data
Sep. 21, 1977 [JP] Japan 52-37588

[51] Int. Cl. D23-04
[52] U.S. Cl. D23/146
[58] Field of Search D23/139-167;
D24/62; 128/186, 187, 191 A; 219/271-276,
284, 288; 261/91, 142

[56] References Cited
U.S. PATENT DOCUMENTS

D. 179,100 10/1956 Tauben D23/148
D. 181,548 11/1957 Reading et al. D23/148
D. 185,184 5/1959 Anderson D23/148

D. 187,171 2/1960 Russell D23/148
D. 197,937 4/1964 Katzman et al. D23/148
D. 199,474 10/1964 Storch D23/148
D. 235,450 6/1975 Chapman D23/148
2,615,215 10/1952 Stagner D23/150 X
2,713,628 7/1955 Barkin D23/148 X
3,130,246 4/1964 Banks D23/146 X

Primary Examiner—James R. Largen
Attorney, Agent, or Firm—Stevens, Davis, Miller & Mosher

[57] CLAIM

The ornamental design for a humidifier, as shown.

DESCRIPTION

FIG. 1 is a top perspective view of the humidifier showing my new design;
FIG. 2 is a bottom perspective view thereof;
FIG. 3 is a front elevational view thereof;
FIG. 4 is a left side elevational view thereof;
FIG. 5 is a top plan view thereof;
FIG. 6 is a bottom plan view thereof;
FIG. 7 is a top perspective view thereof with the top cover removed; and
FIG. 8 is a top plan view of FIG. 7.

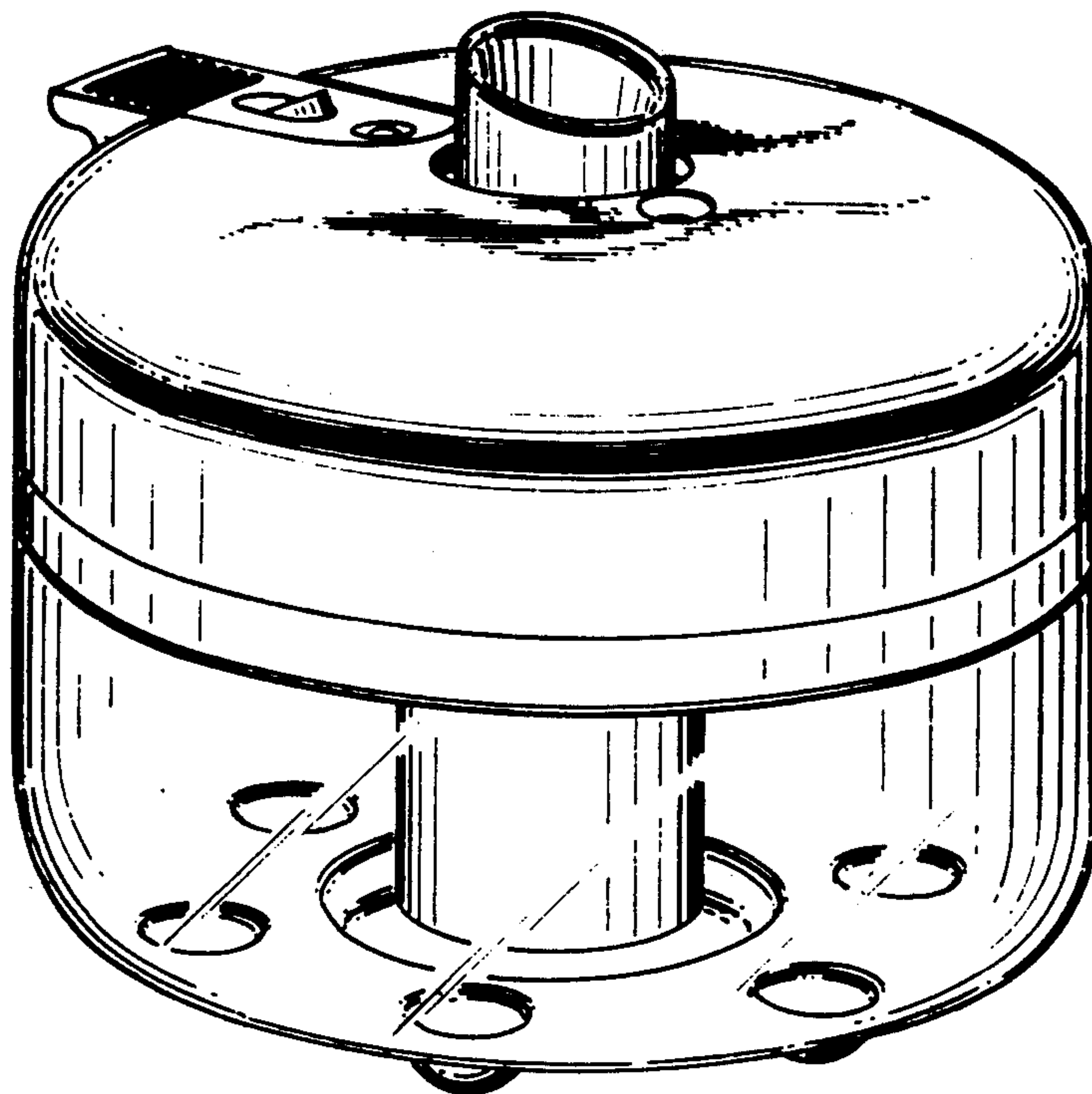

FIG. 1

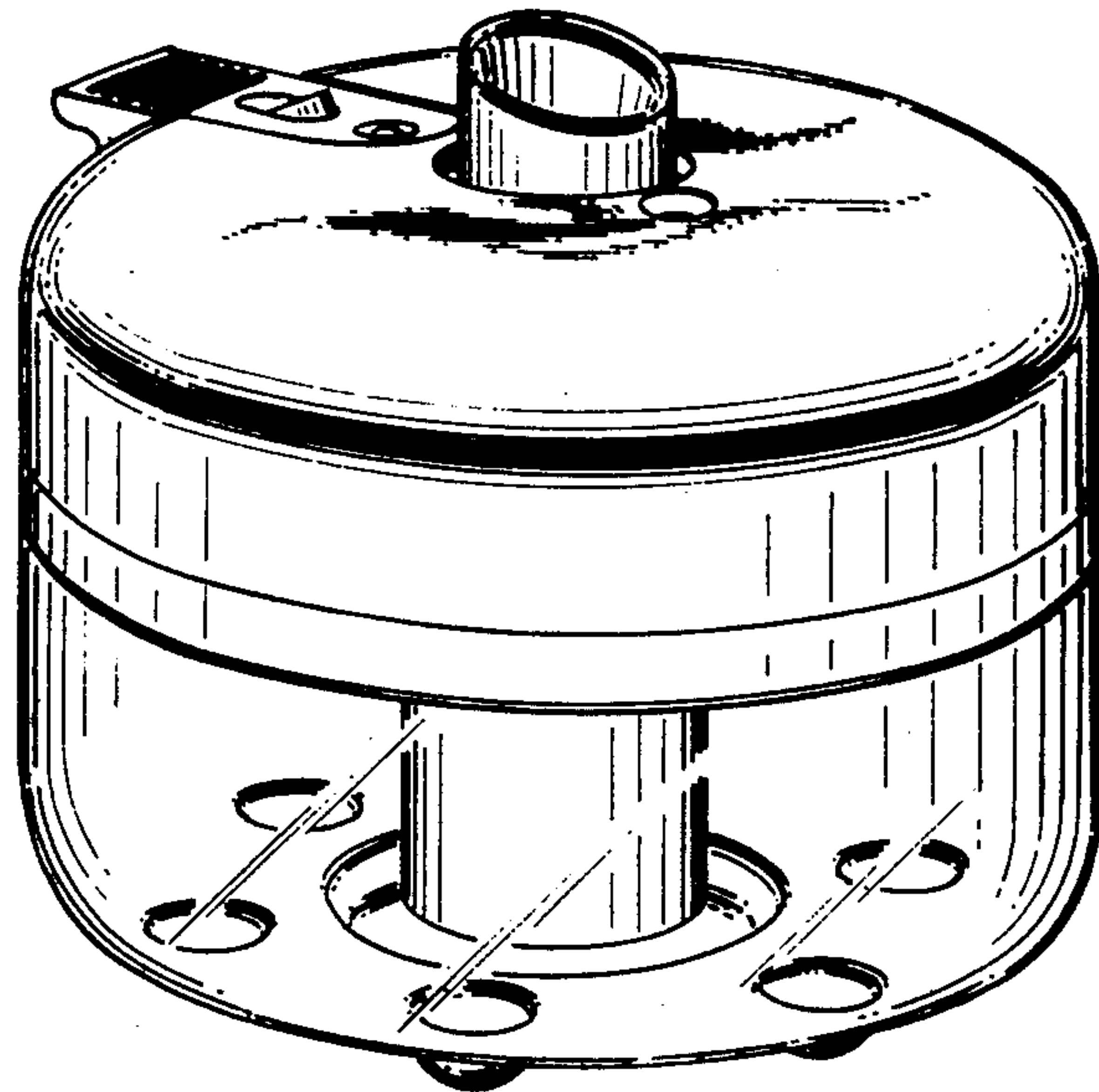

FIG. 2

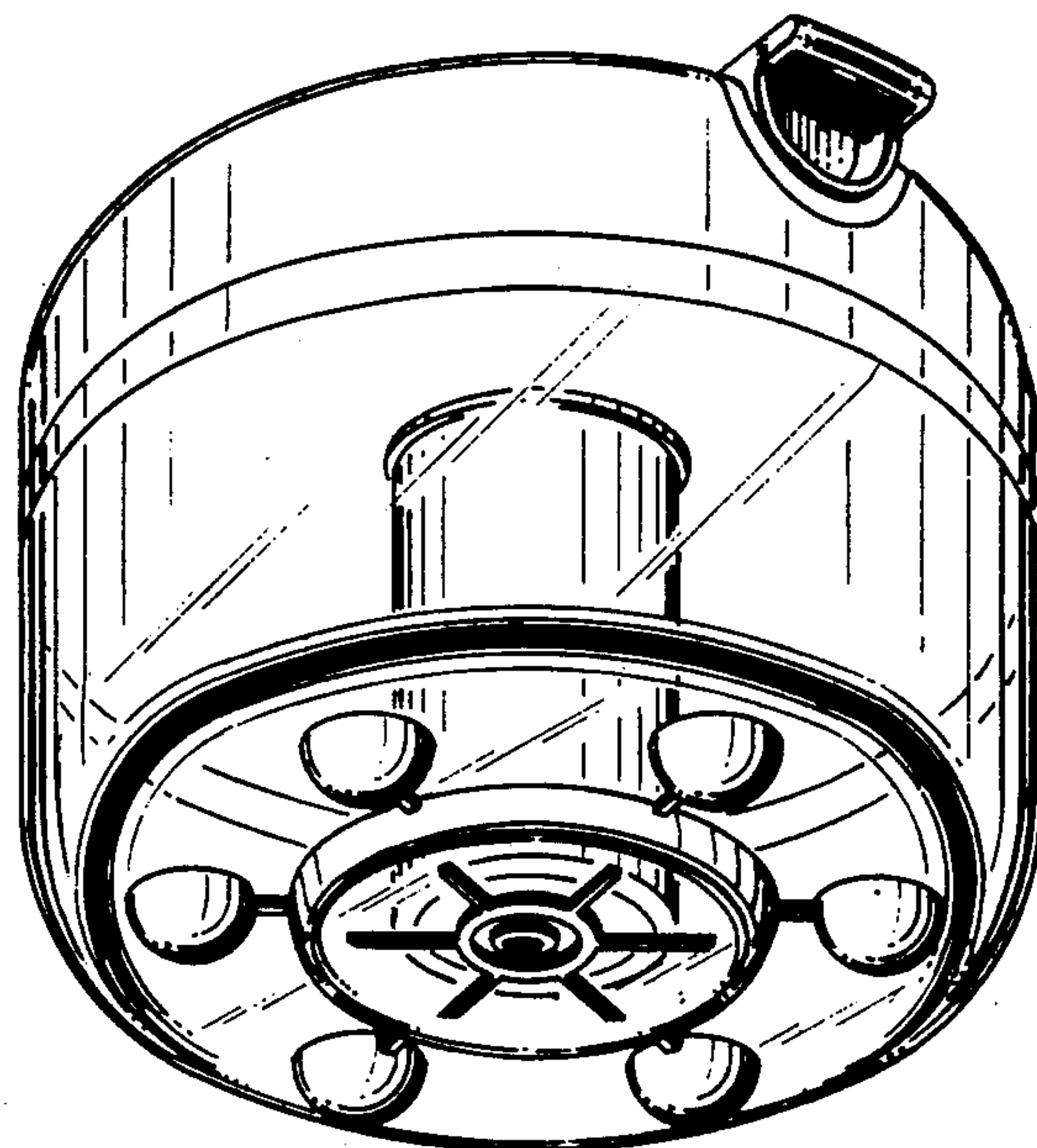

FIG. 3

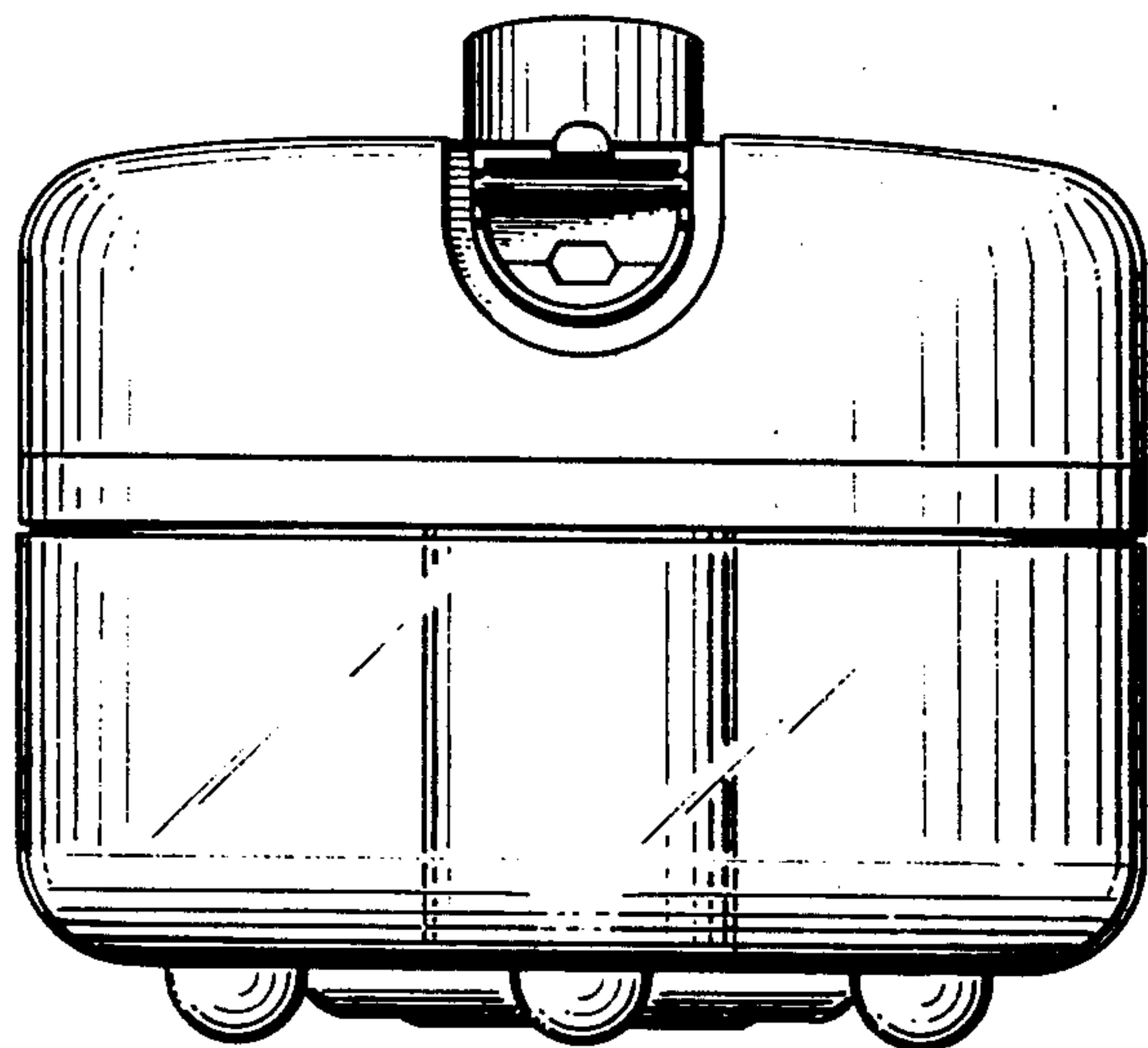

FIG. 4

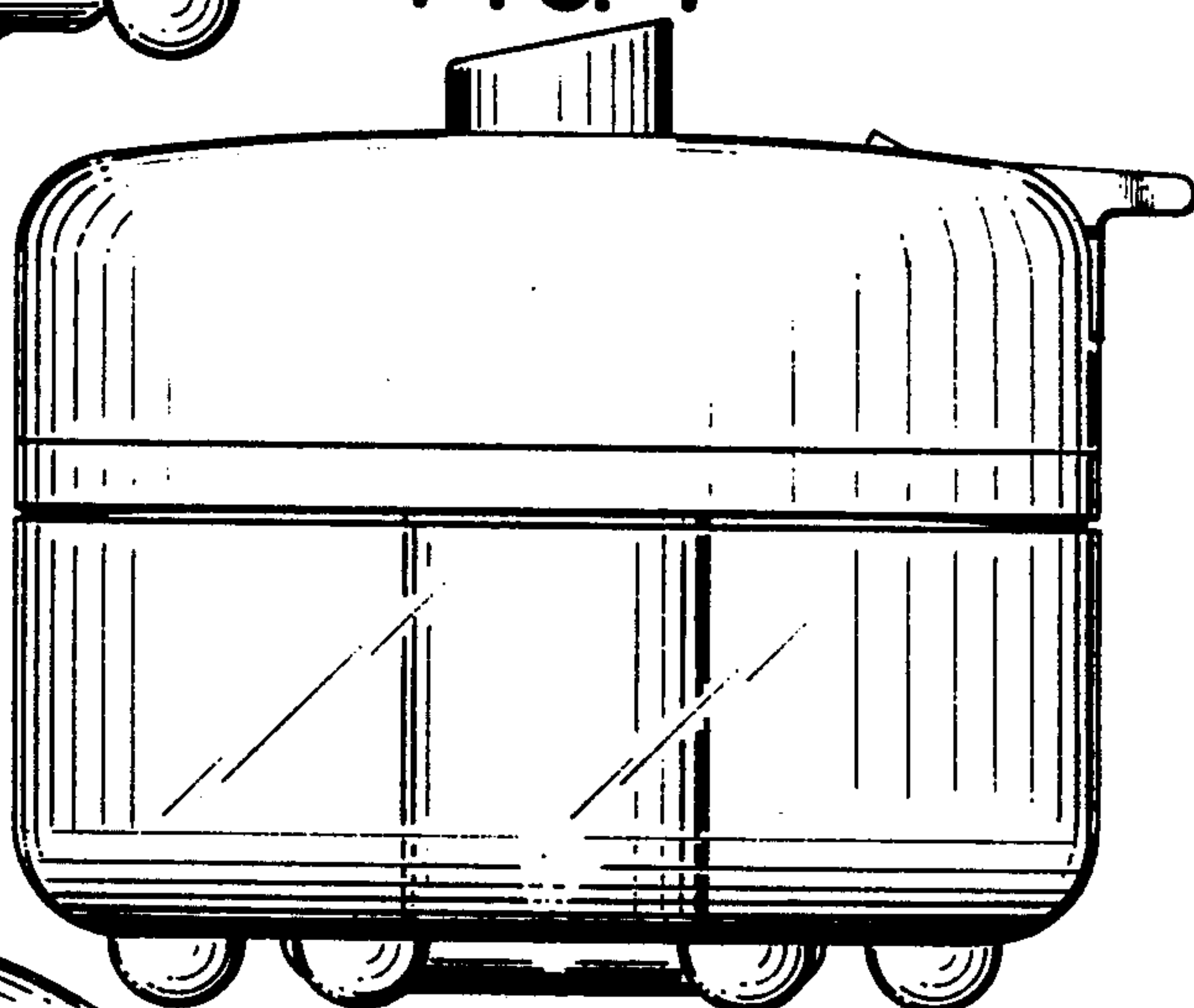

FIG. 5

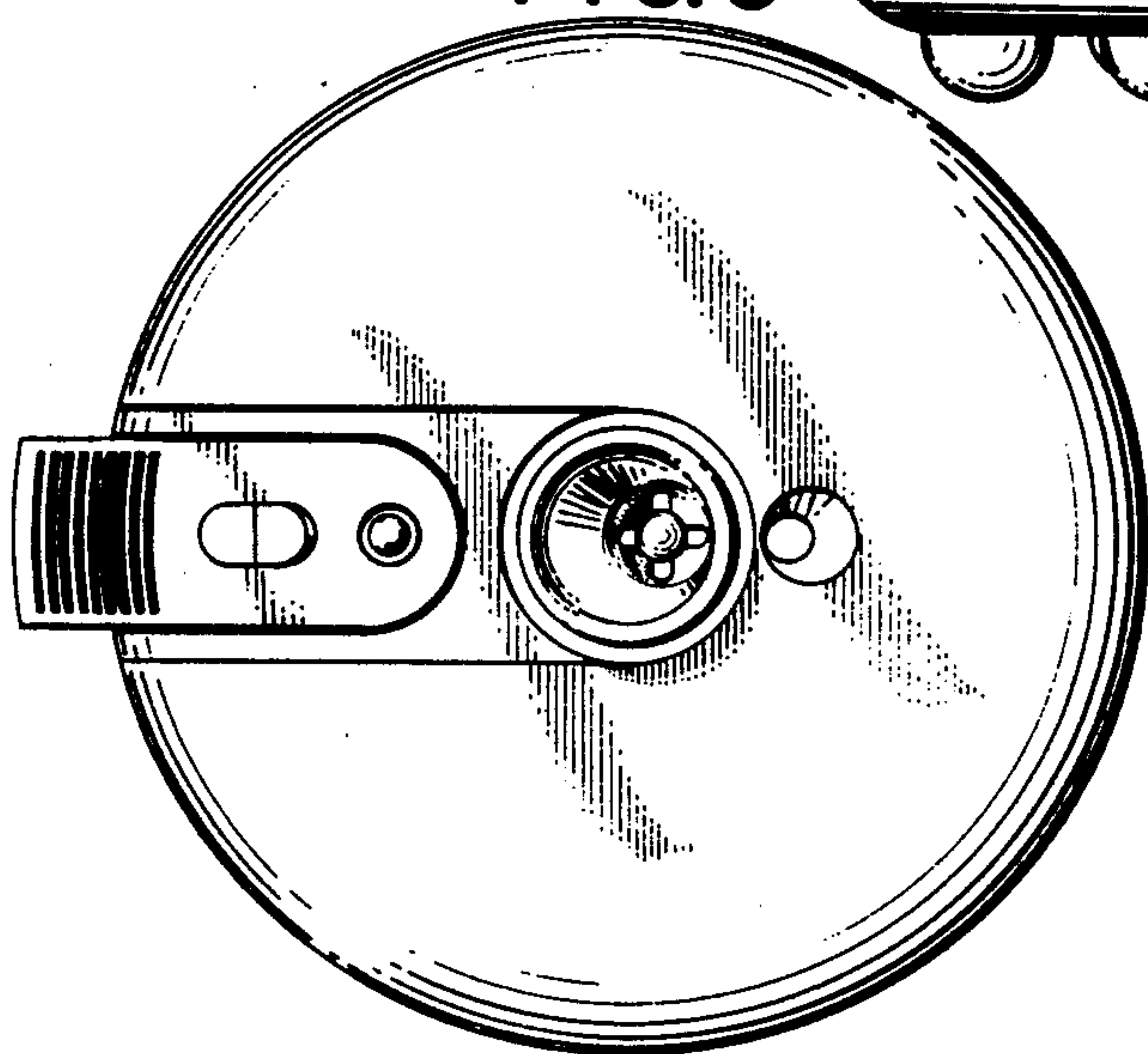

FIG. 6

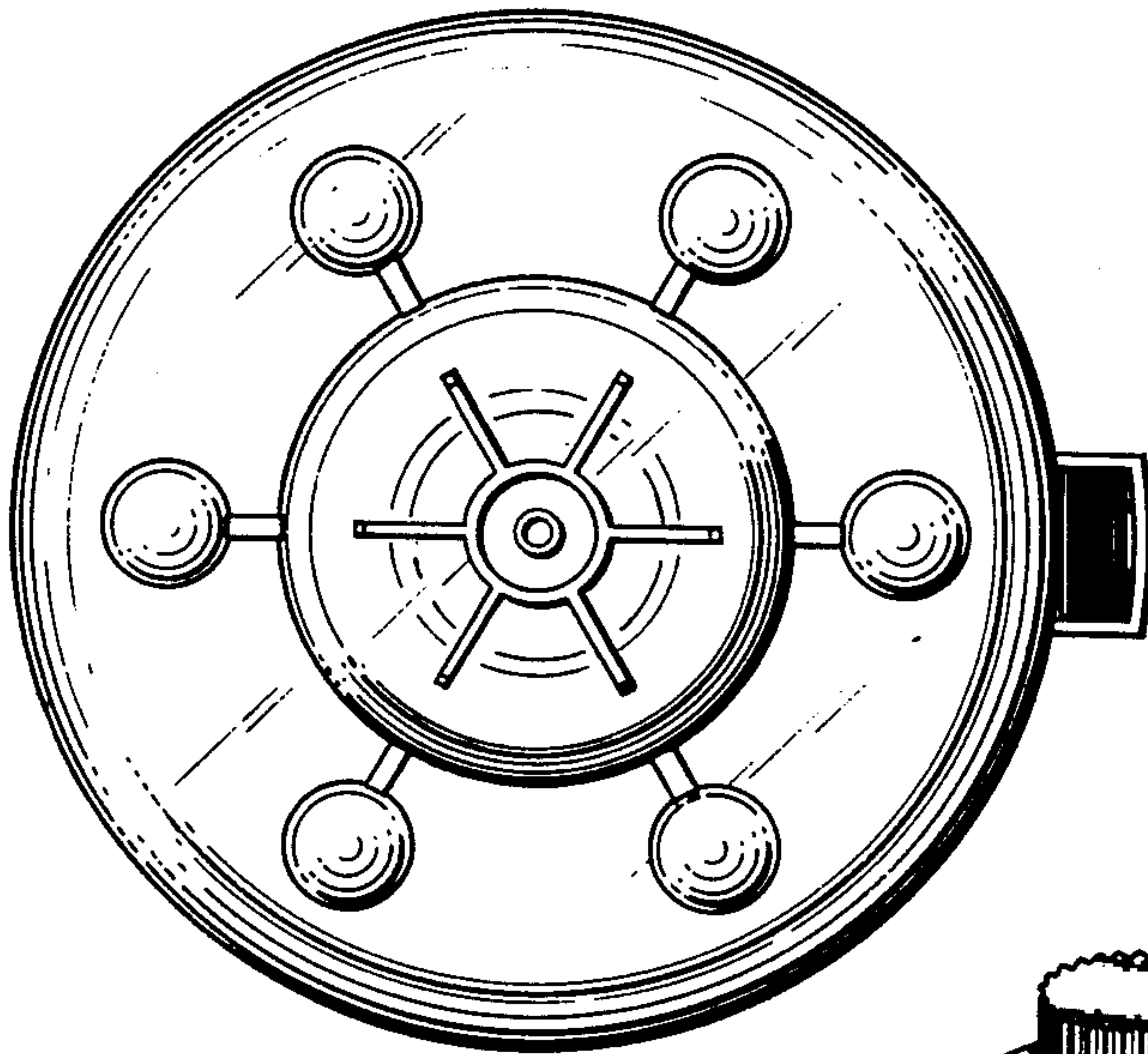

FIG. 7

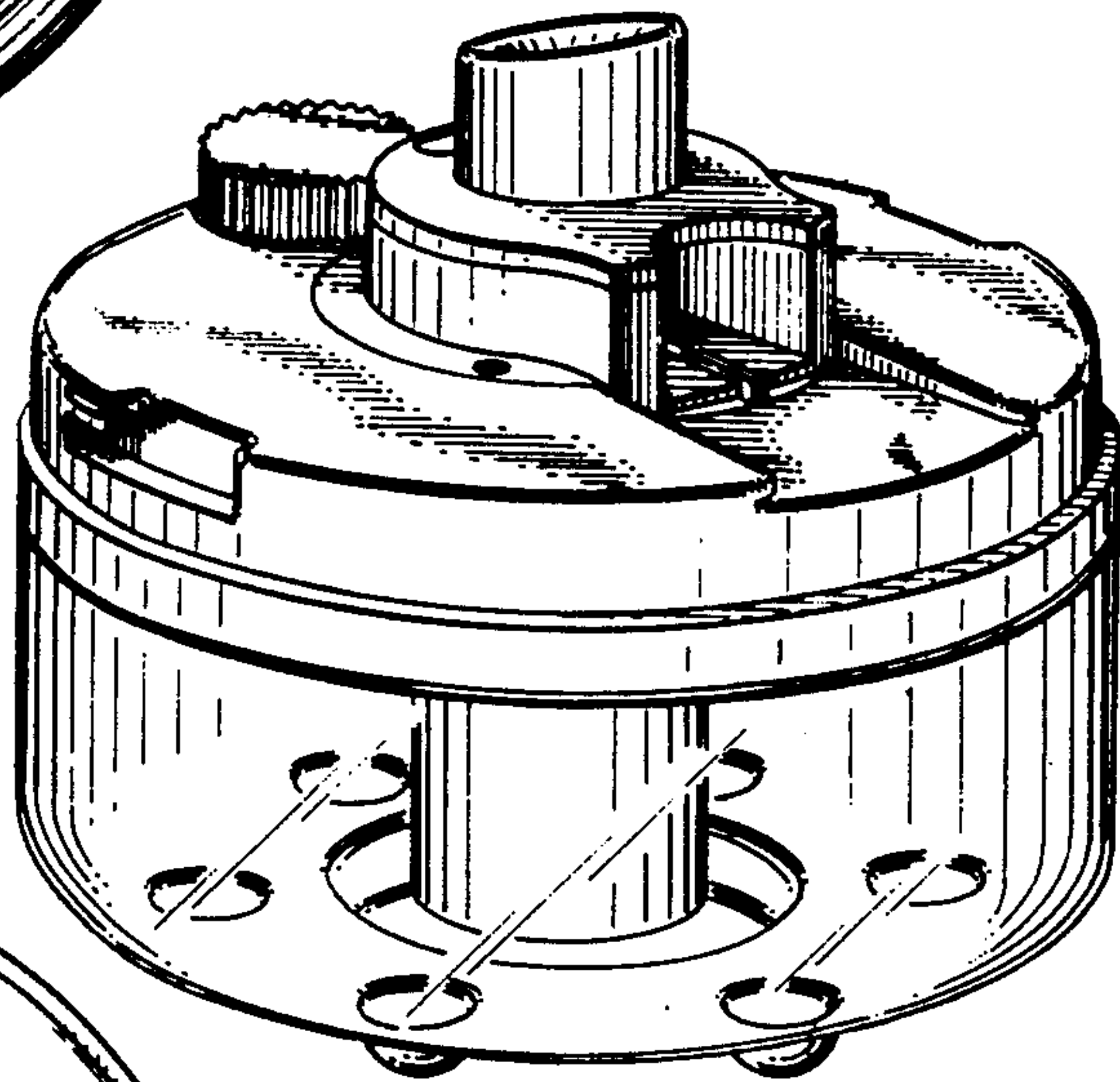

FIG. 8

