

[54] COVER FOR A PLATE OR THE LIKE

[75] Inventor: Richard H. Seager, Mystic, Conn.

[73] Assignee: King-Seeley Thermos Co., Norwich, Conn.

[**] Term: 14 Years

[21] Appl. No.: 853,646

[22] Filed: Nov. 21, 1977

[51] Int. Cl. D07-01

[52] U.S. Cl. D7/40

[58] Field of Search D7/40, 131, 83, 17, D7/21, 3, 38, 76, 37; 220/23.83, 215

[56] References Cited

U.S. PATENT DOCUMENTS

D. 49,544	8/1916	Maier	D7/17
D. 191,124	8/1961	Barron et al.	D7/17
2,627,991	2/1953	Maersch	220/4 E
3,019,783	2/1962	Clarke	D7/38 X
3,066,824	12/1962	Bostrom	220/306

OTHER PUBLICATIONS

Housewares, Jul. 1976, p. 46, Republic's Ice Bucket at top left, Domed Friction-Fit Cover with Recessed Knob.

Primary Examiner—Winifred E. Herrmann
Attorney, Agent, or Firm—Harness, Dickey & Pierce

[57] CLAIM

The ornamental design for a cover for a plate or the like, substantially as shown and described.

DESCRIPTION

FIG. 1 is a top perspective view of a cover for a plate or the like showing my new design.

FIG. 2 is a top plan view of the design.

FIG. 3 is a side elevational view of the design.

FIG. 4 is a bottom plan view of the design.

FIG. 5 is a cross-sectional view taken along the line 5-5 of FIG. 2.

The external surface of the design constitutes a surface of revolution and thus the side elevational view of FIG. 3 is typical regardless of which portion of the design is viewed in this plane.

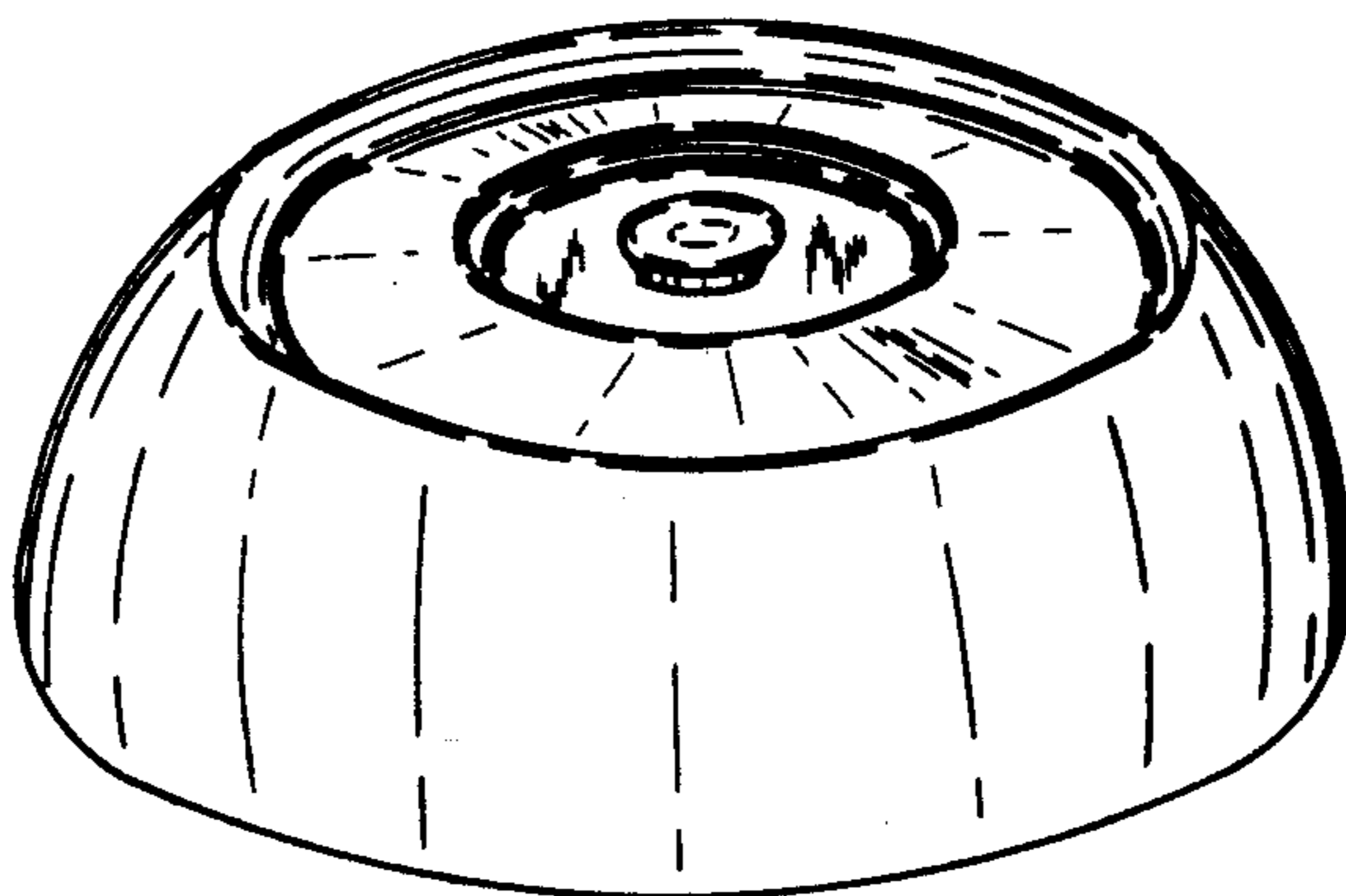
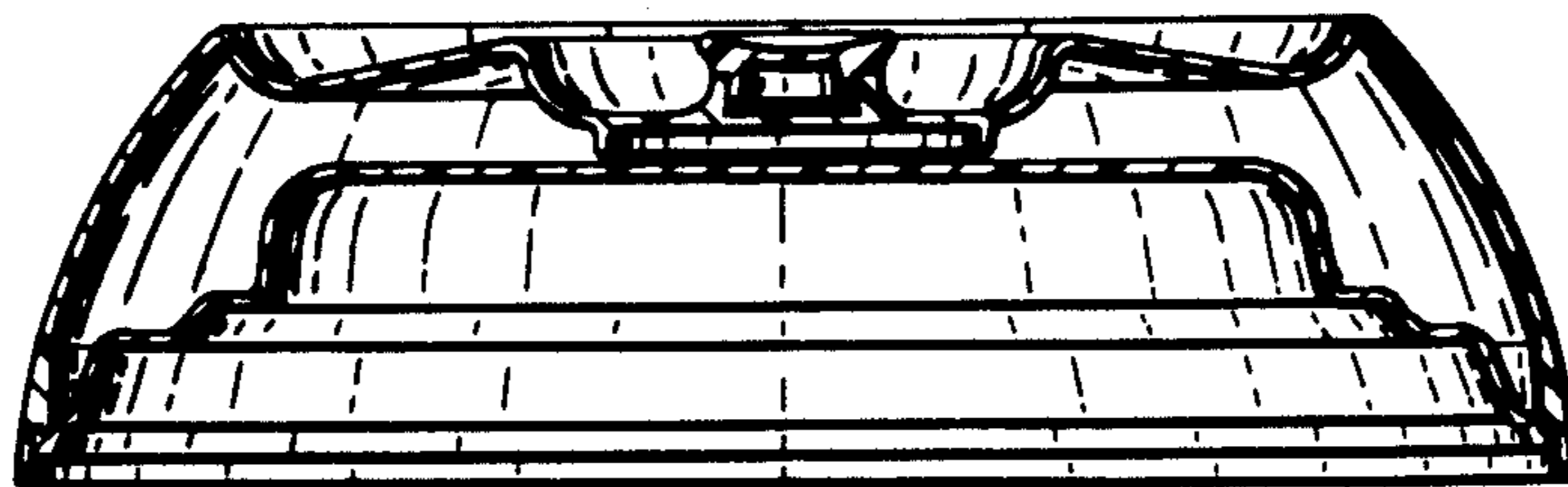

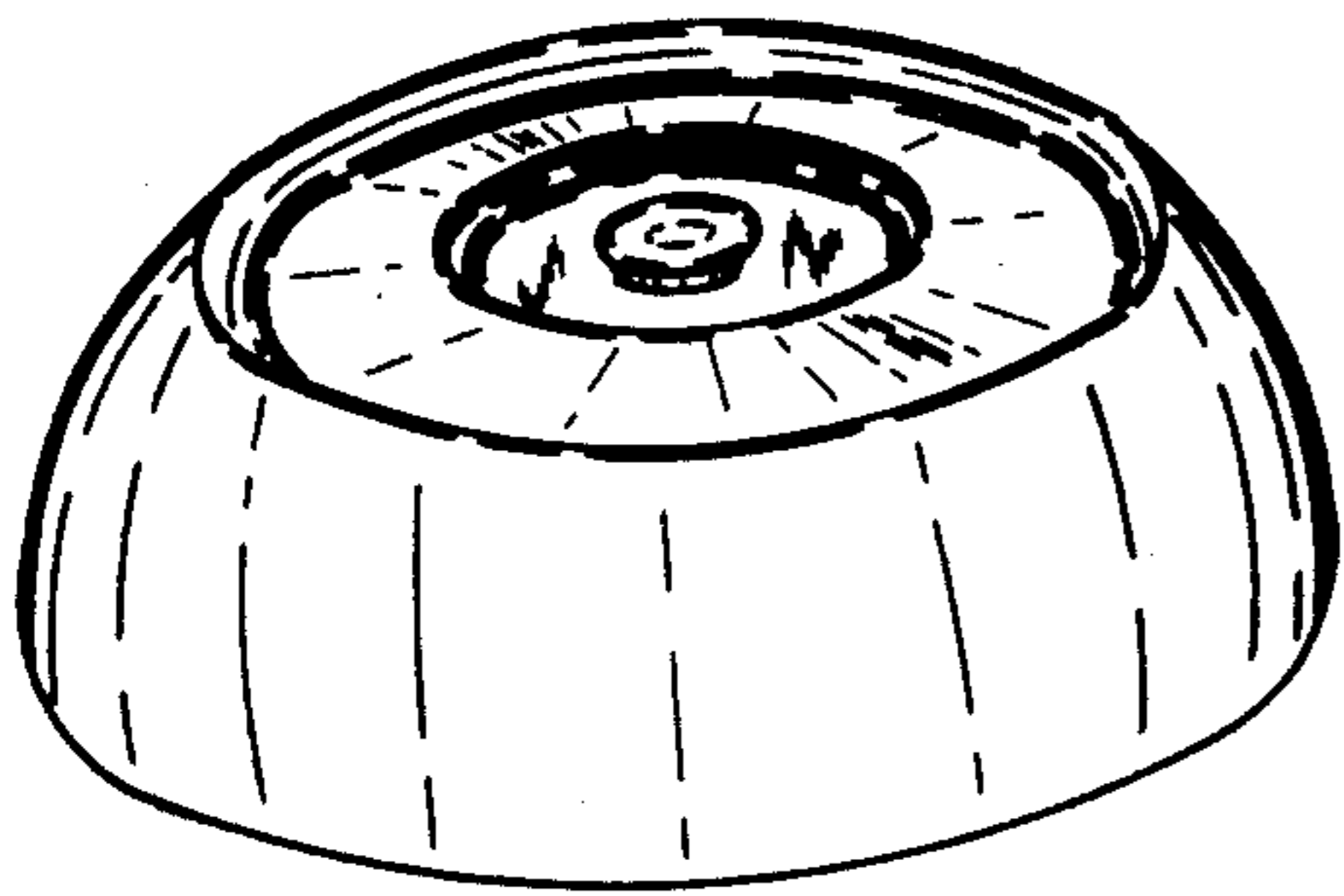

FIG. 1.

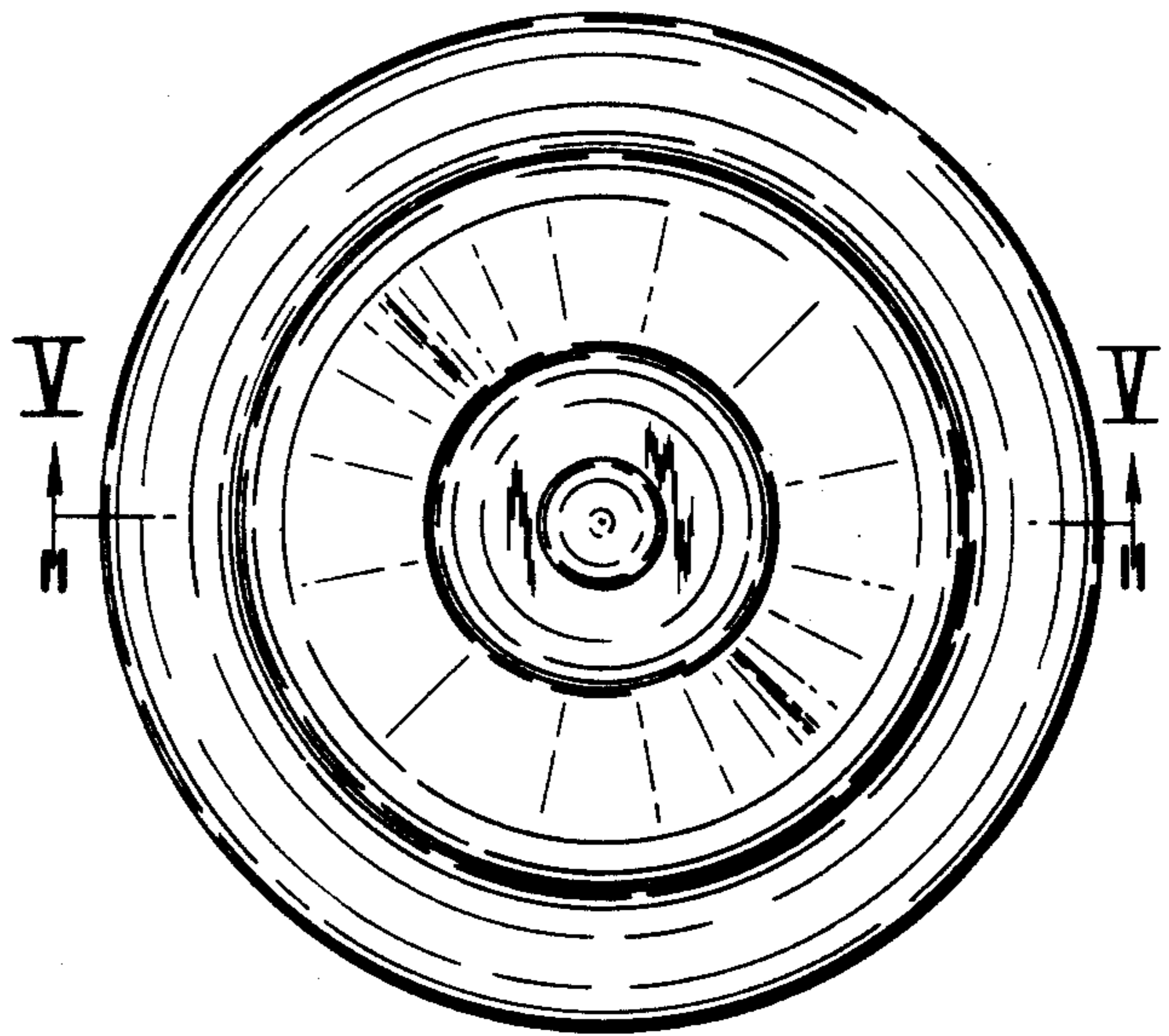

FIG. 2.

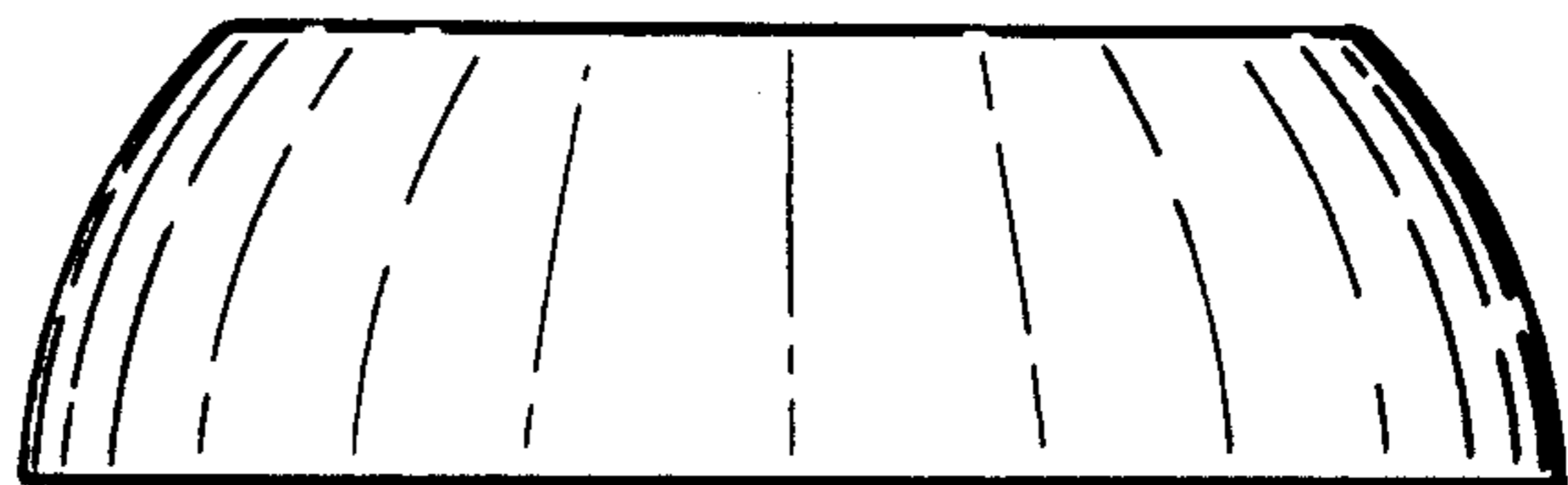

FIG. 3.

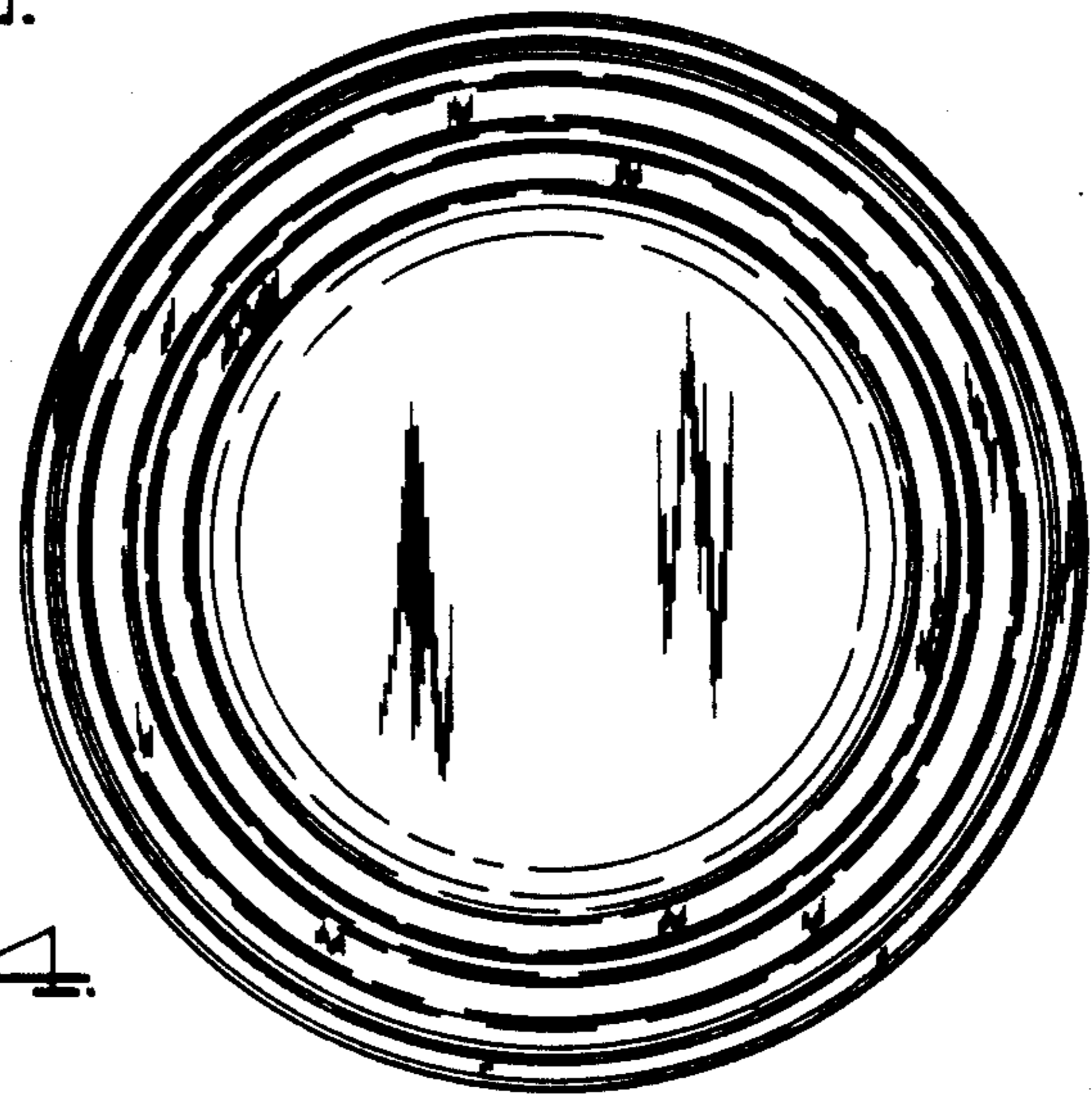

FIG. 4.

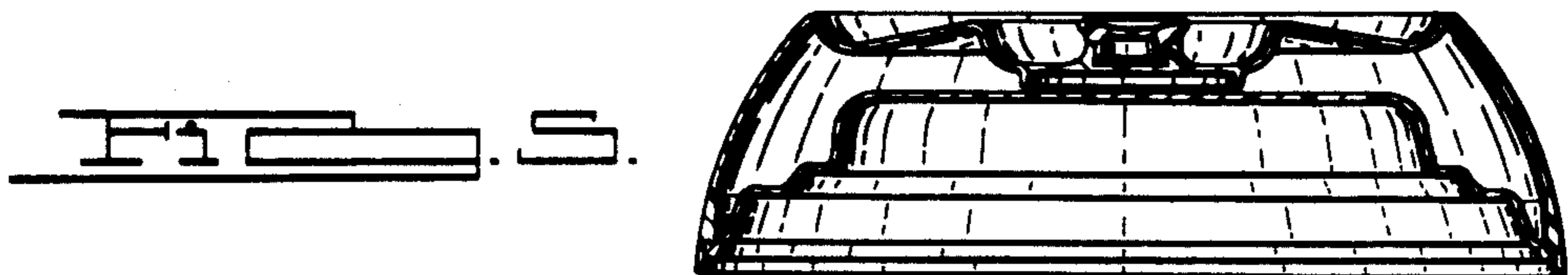

FIG. 5.