

[54] INDUSTRIAL VACUUM CLEANER

DESCRIPTION

[75] Inventors: Joseph F. Brooks; Vernon E. Flanders, both of Bloomington, Ill.  
 [73] Assignee: National Union Electric Corporation, Greenwich, Conn.  
 [\*\*] Term: 14 Years  
 [21] Appl. No.: 683,686  
 [22] Filed: May 5, 1976  
 [51] Int. Cl. .... D15-05  
 [52] U.S. Cl. .... D15/54  
 [58] Field of Search ..... D15/49, 52, 54, 39, D15/48; 15/300 R, 319, 320, 322, 325, 327, 340, 344, 347, 349, 353, 49 R, 50 R

FIG. 1 is a perspective view of an industrial vacuum cleaner embodying our new design;  
 FIG. 2 is a top plan view thereof;  
 FIG. 3 is a front elevational view thereof;  
 FIG. 4 is a side elevational view thereof;  
 FIG. 5 is a rear elevational view thereof;  
 FIG. 6 is a bottom plan view thereof;  
 FIG. 7 is a top plan view of a second embodiment thereof;  
 FIG. 8 is a front elevational view thereof;  
 FIG. 9 is a side elevational view thereof;  
 FIG. 10 is a rear elevational view thereof;  
 FIG. 11 is a bottom plan view thereof;  
 FIG. 12 is a perspective view of a third embodiment thereof;  
 FIG. 13 is a top plan view thereof;  
 FIG. 14 is a front elevational view thereof;  
 FIG. 15 is a side elevational view thereof;  
 FIG. 16 is a rear elevational view thereof;  
 FIG. 17 is a bottom plan view thereof;  
 FIG. 18 is a top plan view of a fourth embodiment thereof;  
 FIG. 19 is a front elevational view thereof;  
 FIG. 20 is a side elevational view thereof;  
 FIG. 21 is a rear elevational view thereof;  
 FIG. 22 is a bottom plan view thereof;  
 FIG. 23 is a top plan view of a fifth embodiment thereof;  
 FIG. 24 is a front elevational view thereof;  
 FIG. 25 is a side elevational view thereof;  
 FIG. 26 is a rear elevational view thereof;  
 FIG. 27 is a bottom plan view thereof.

[56] References Cited

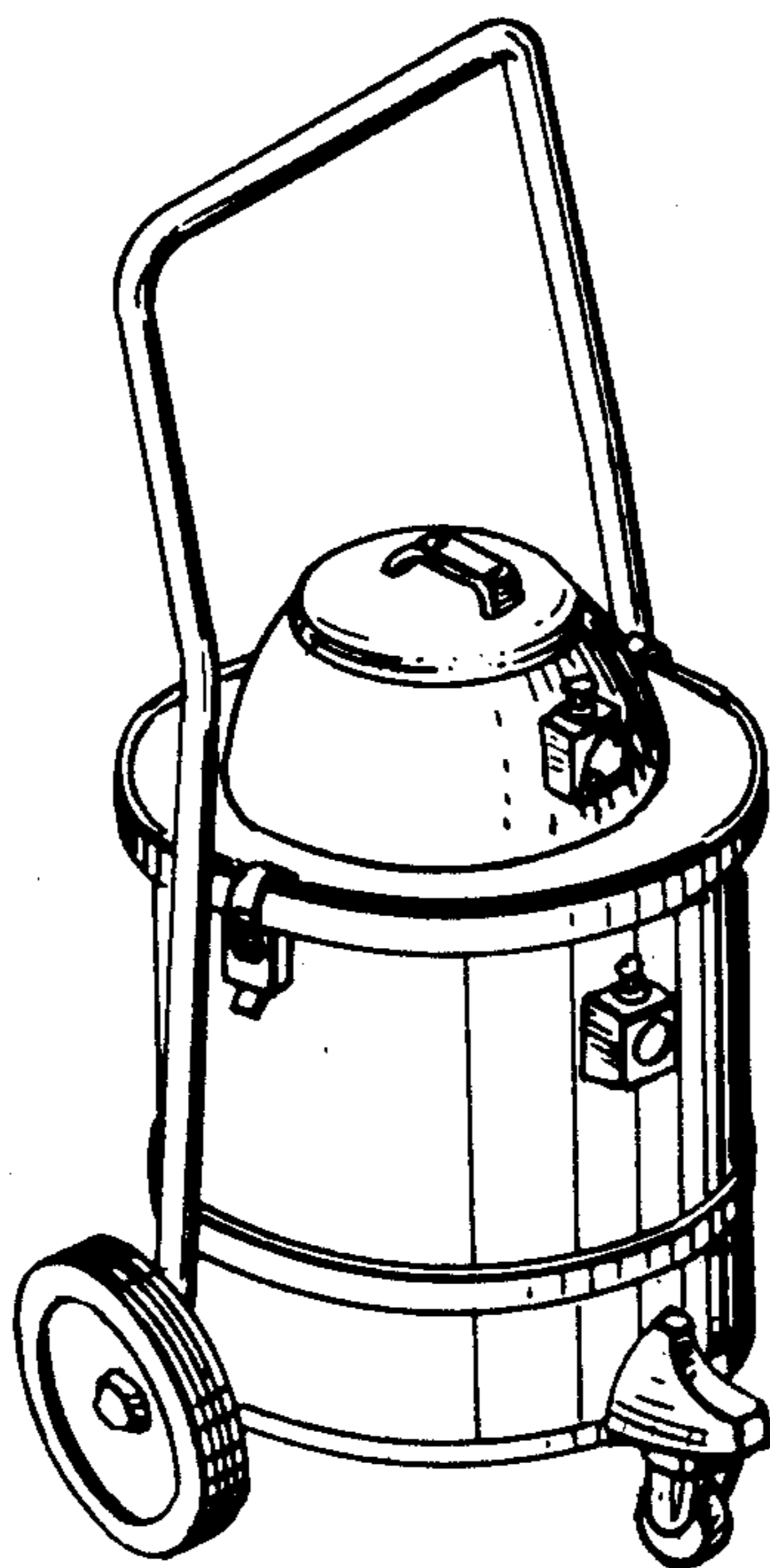
U.S. PATENT DOCUMENTS

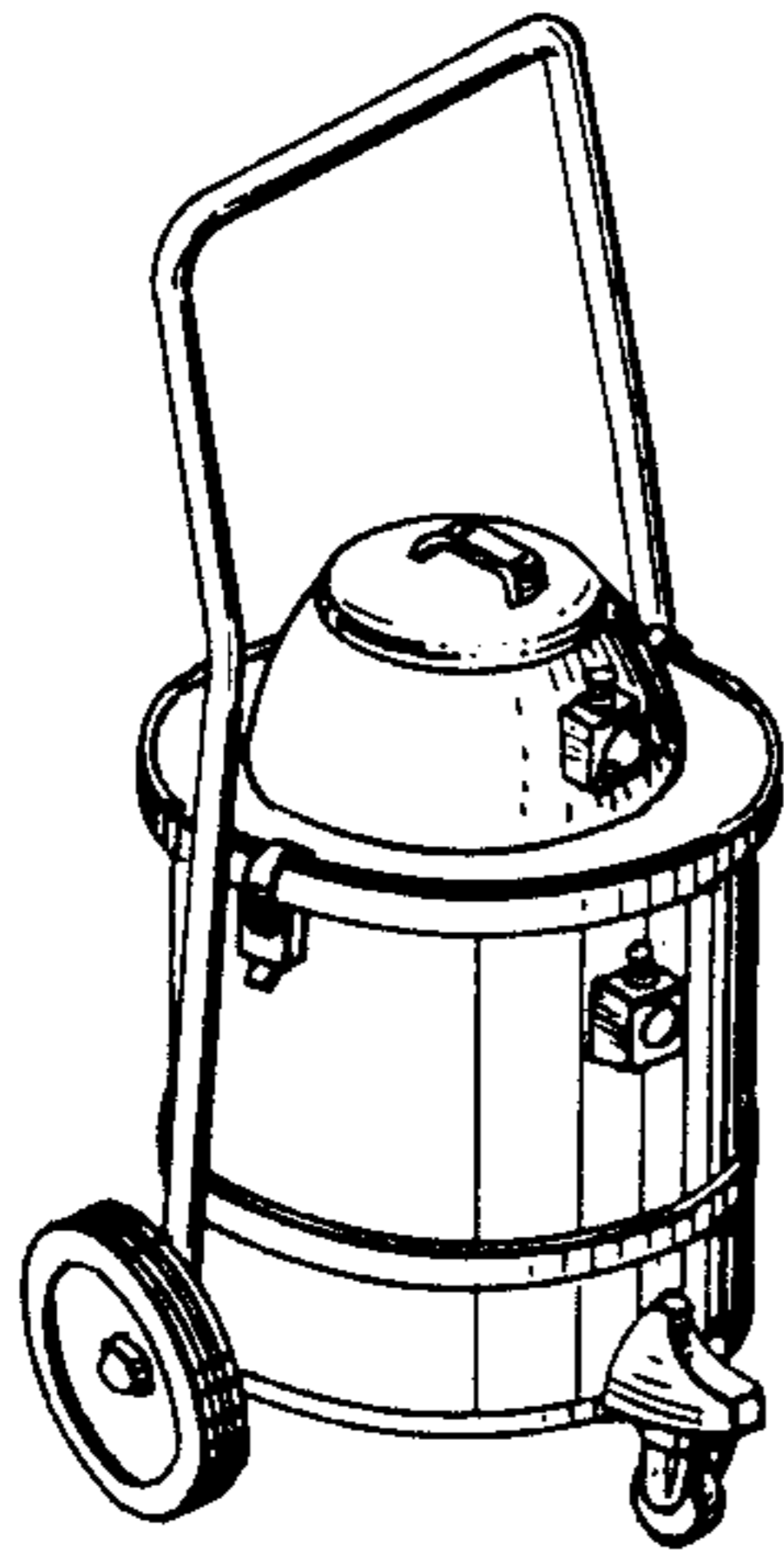
D. 187,065	1/1960	Chapman .....	D15/54
D. 208,398	8/1967	Otto et al. ....	D15/52
D. 212,777	11/1968	Anderson .....	D15/34
D. 239,155	3/1976	Kent et al. ....	D15/49
3,180,071	4/1965	Nolte .....	D15/353 UX

Primary Examiner—Wallace R. Burke  
 Assistant Examiner—Catherine Kemper  
 Attorney, Agent, or Firm—Alfred E. Miller

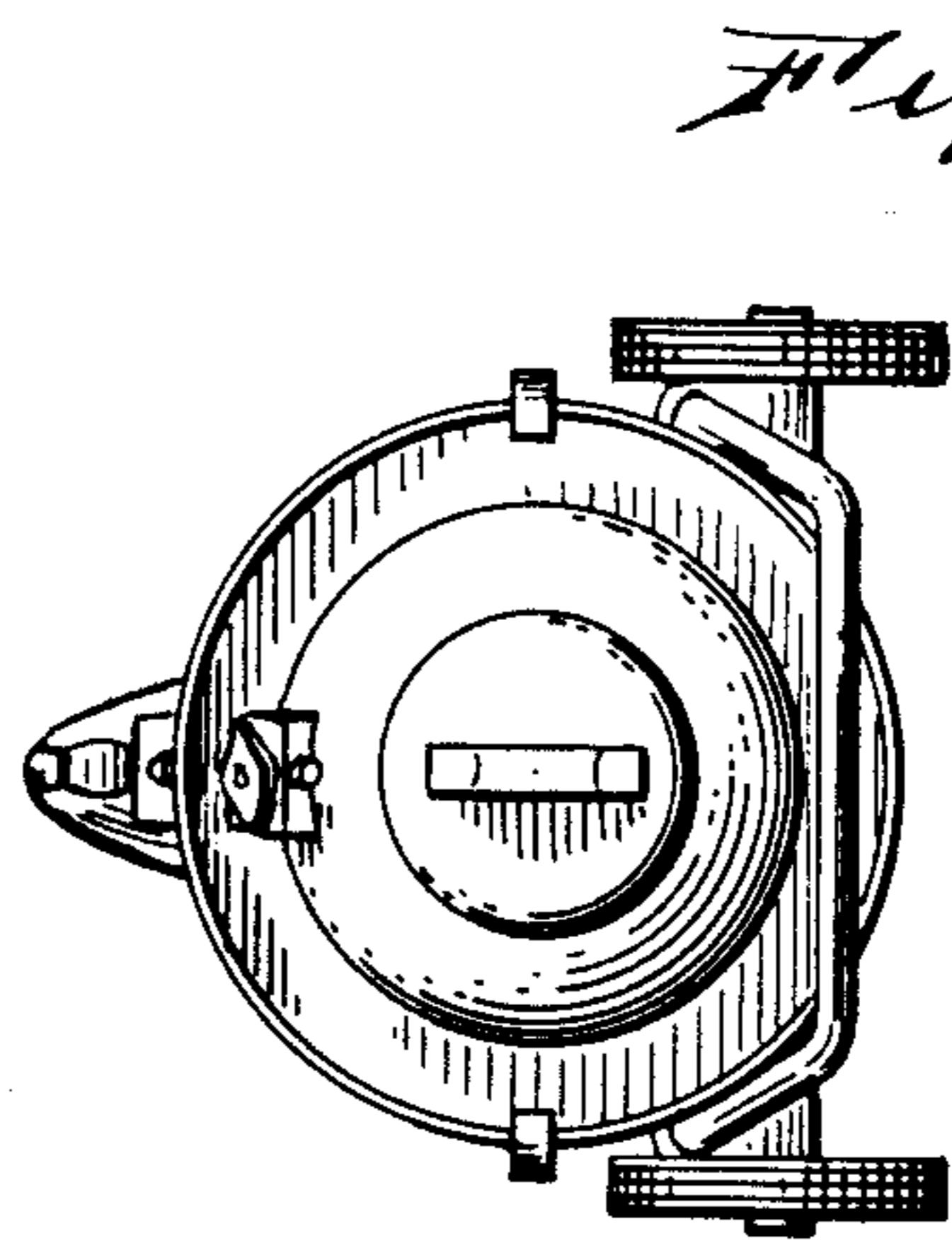
[57] CLAIM

The ornamental design for an industrial vacuum cleaner, as shown and described.



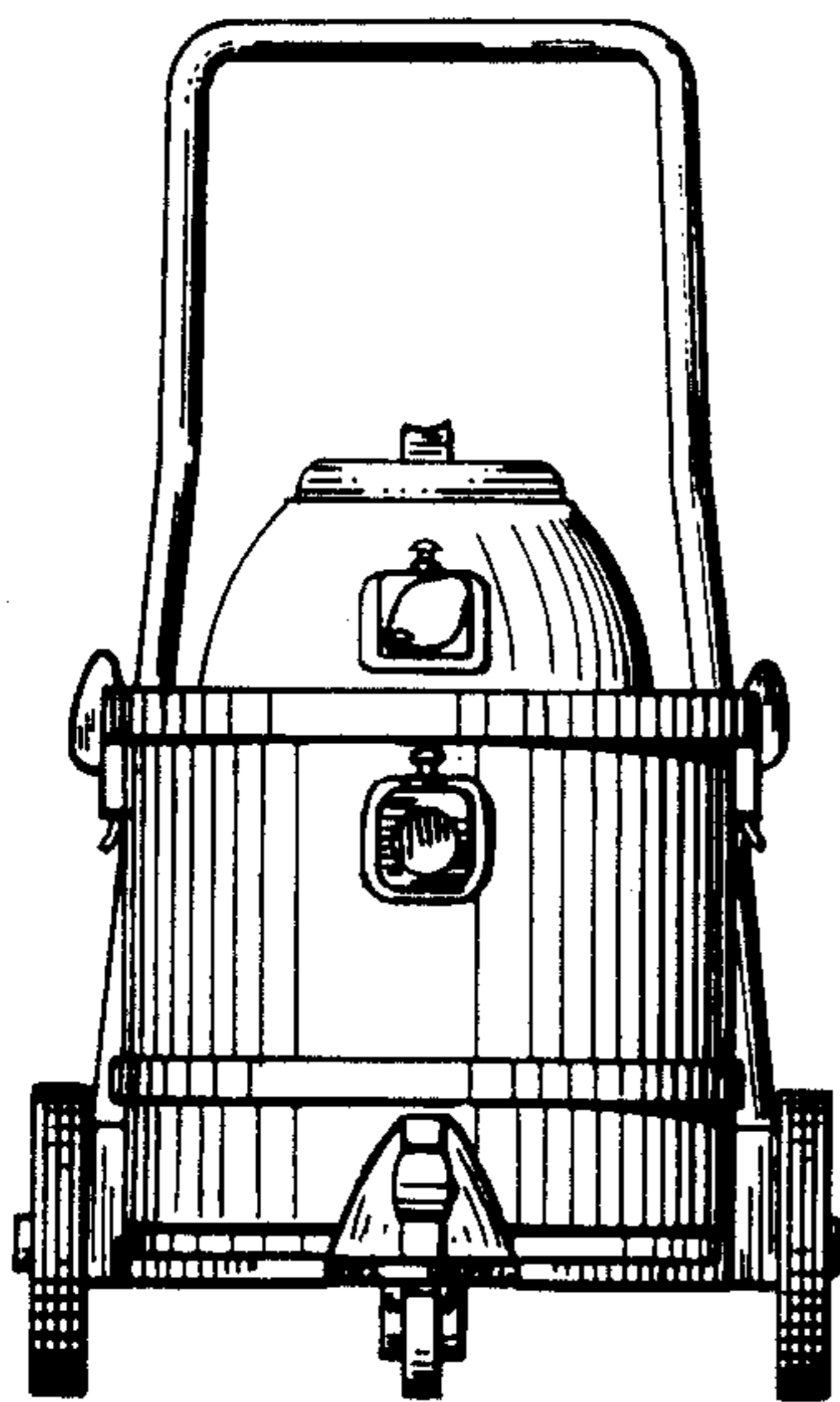


*Fig. 1.*

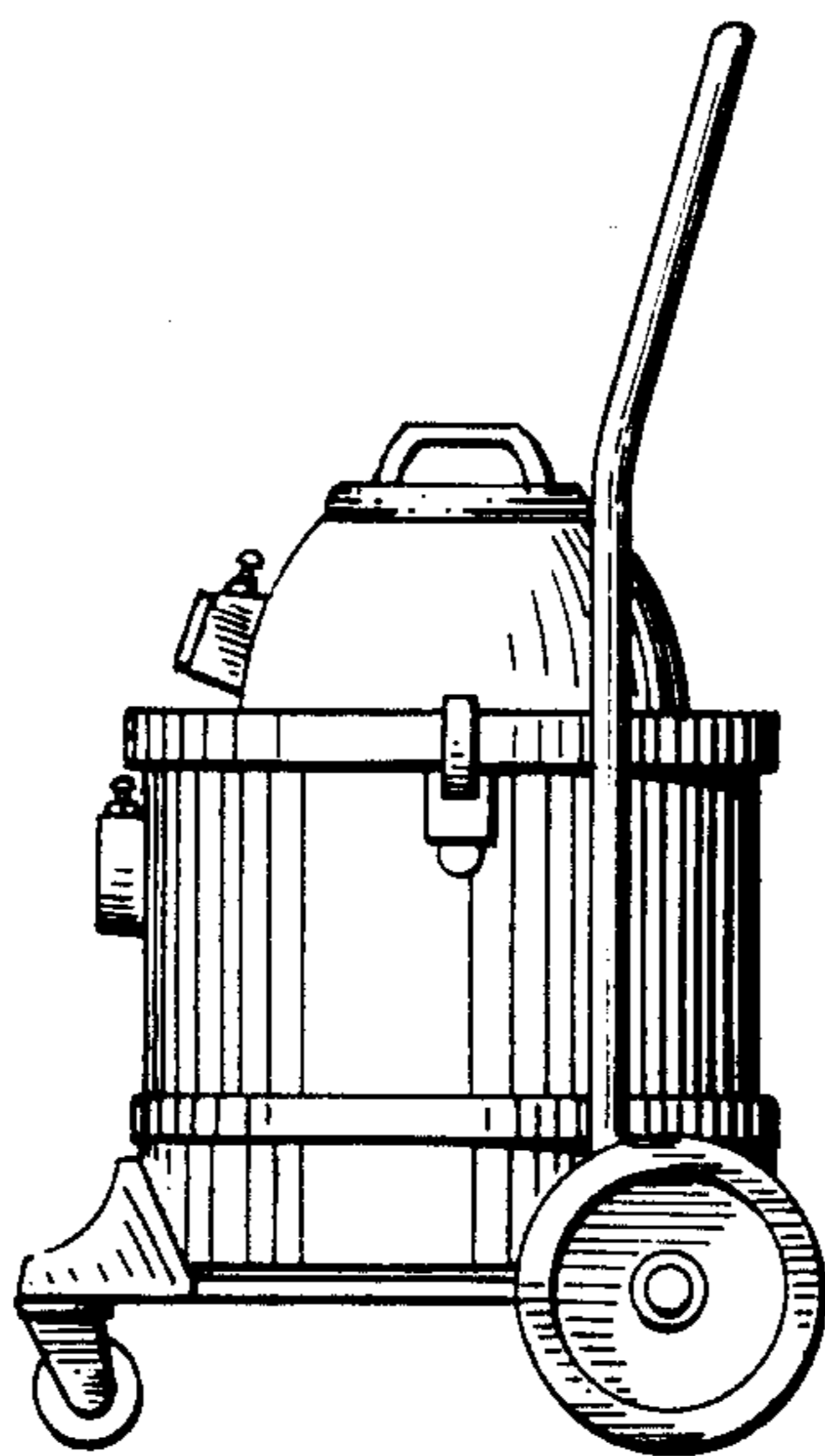


*Fig. 2.*

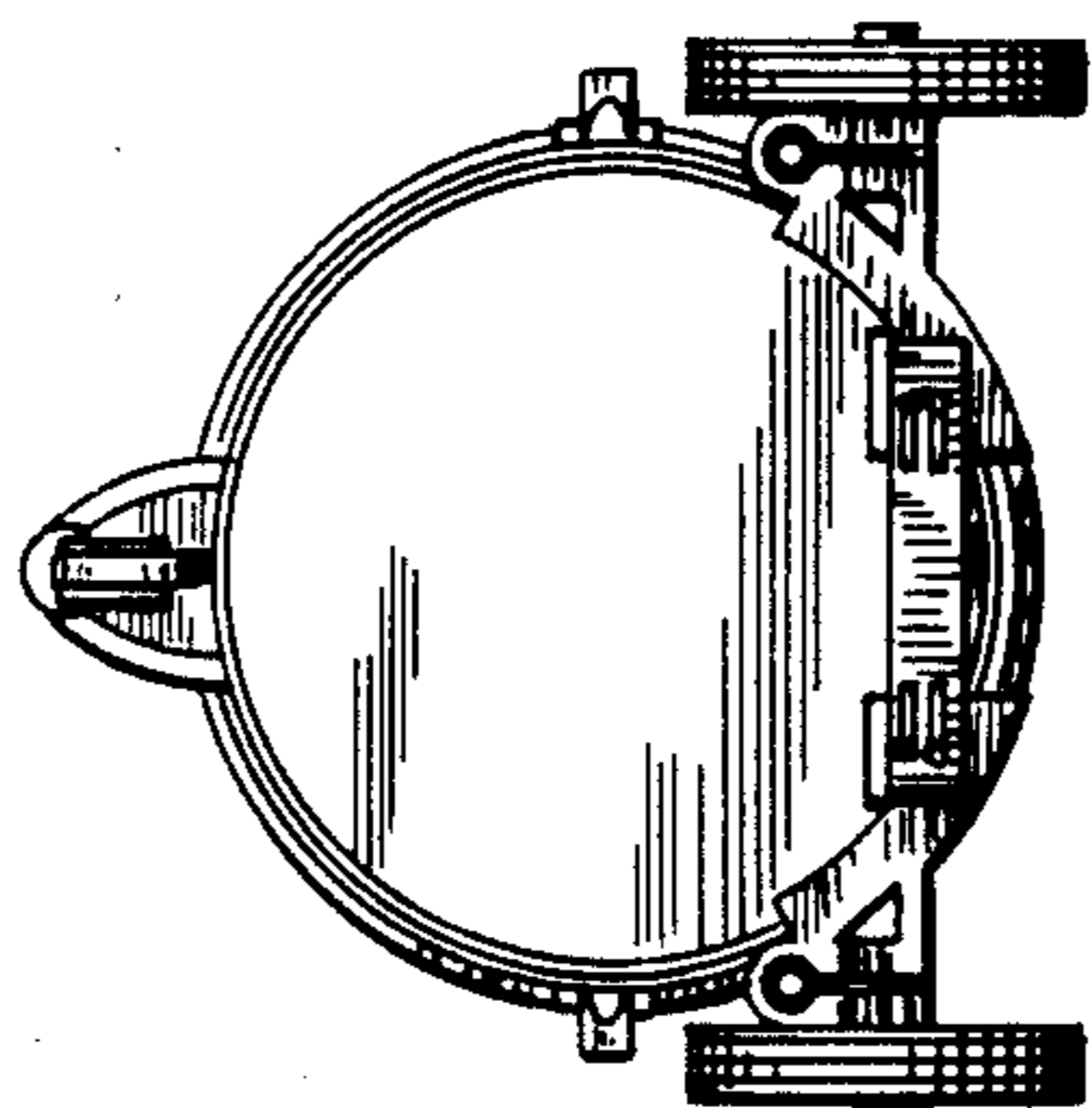
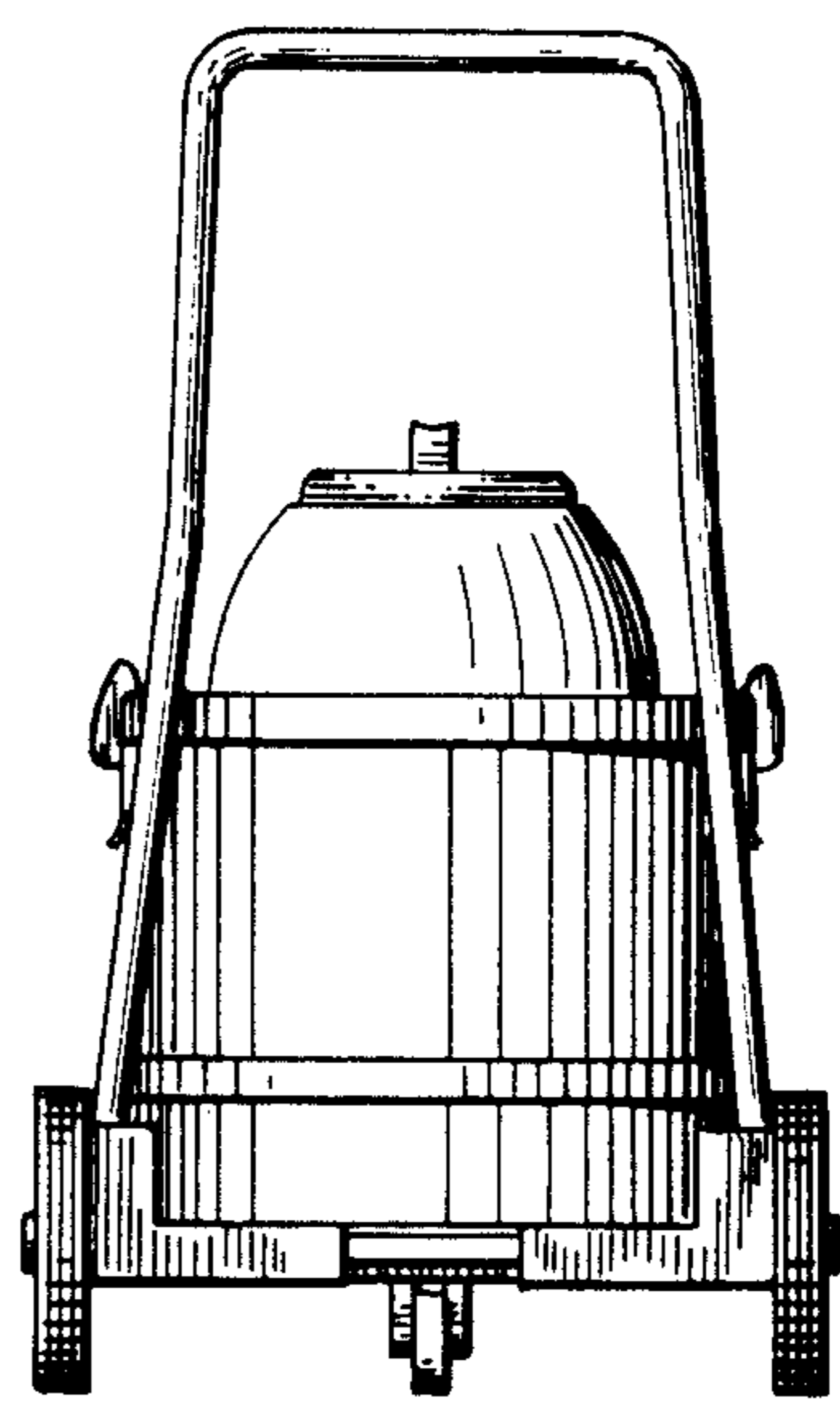
*Fig. 3.*



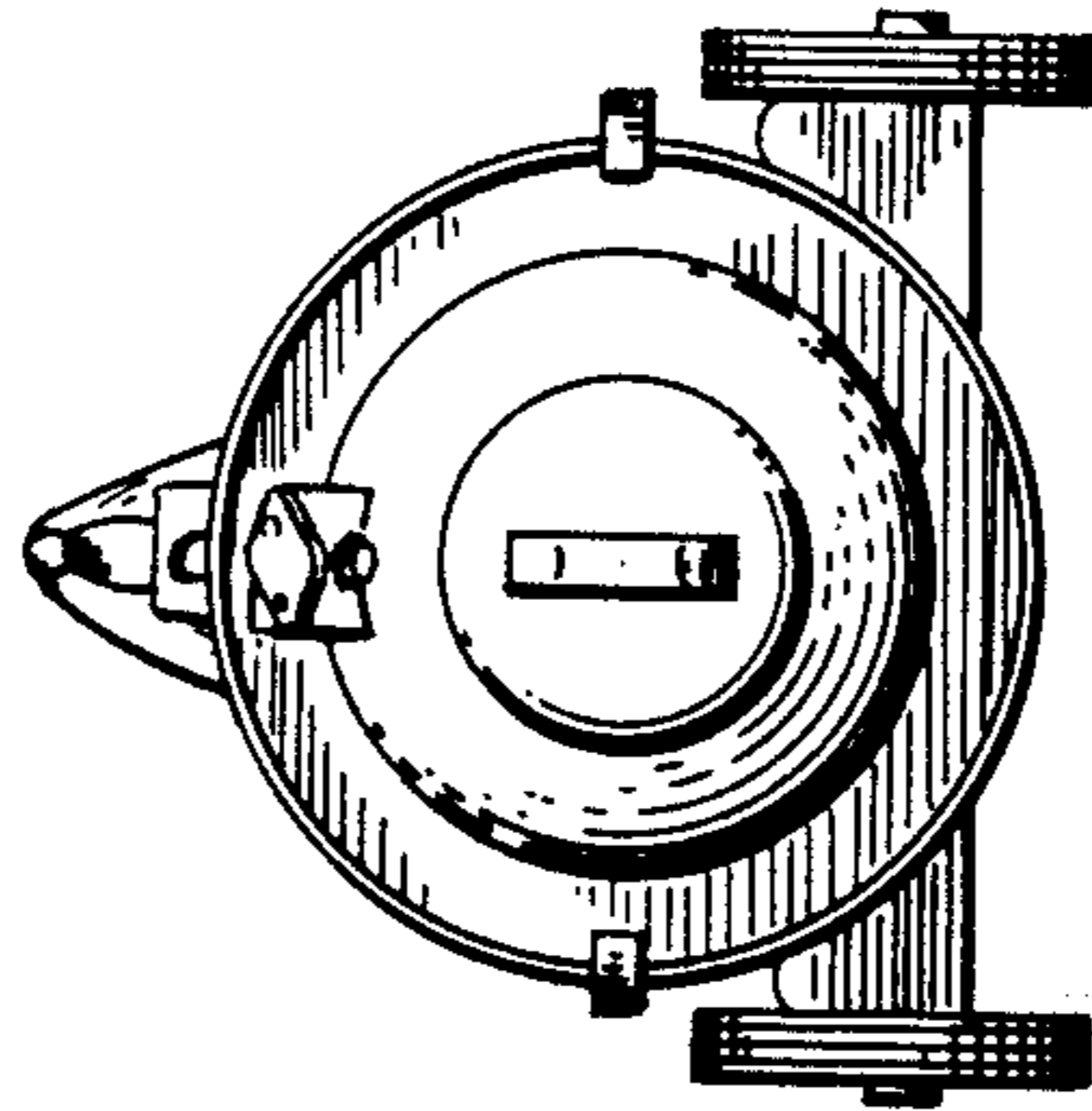
*Fig. 4.*



*Fig. 5.*

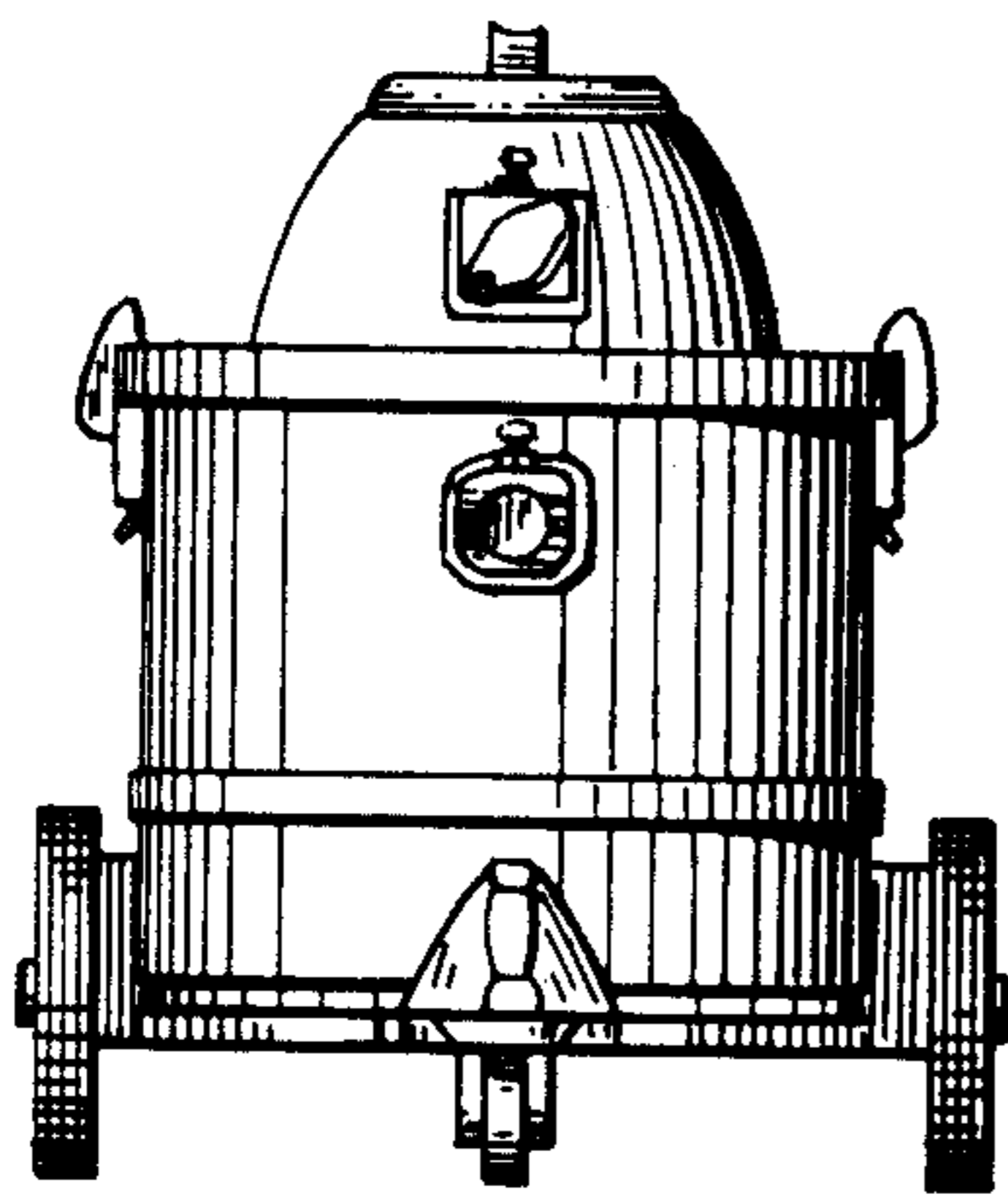


*Fig. 6.*

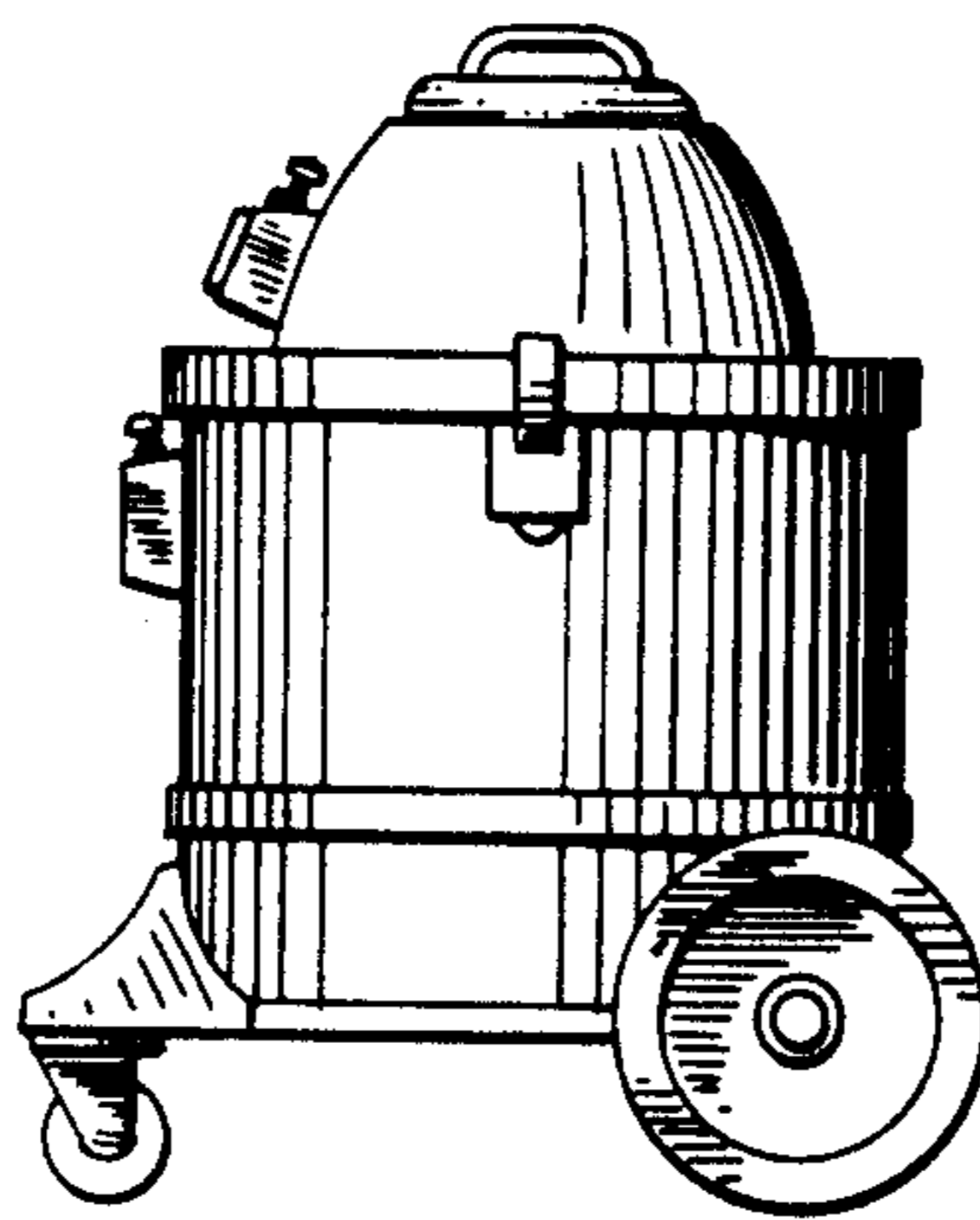


*Fig. 7.*

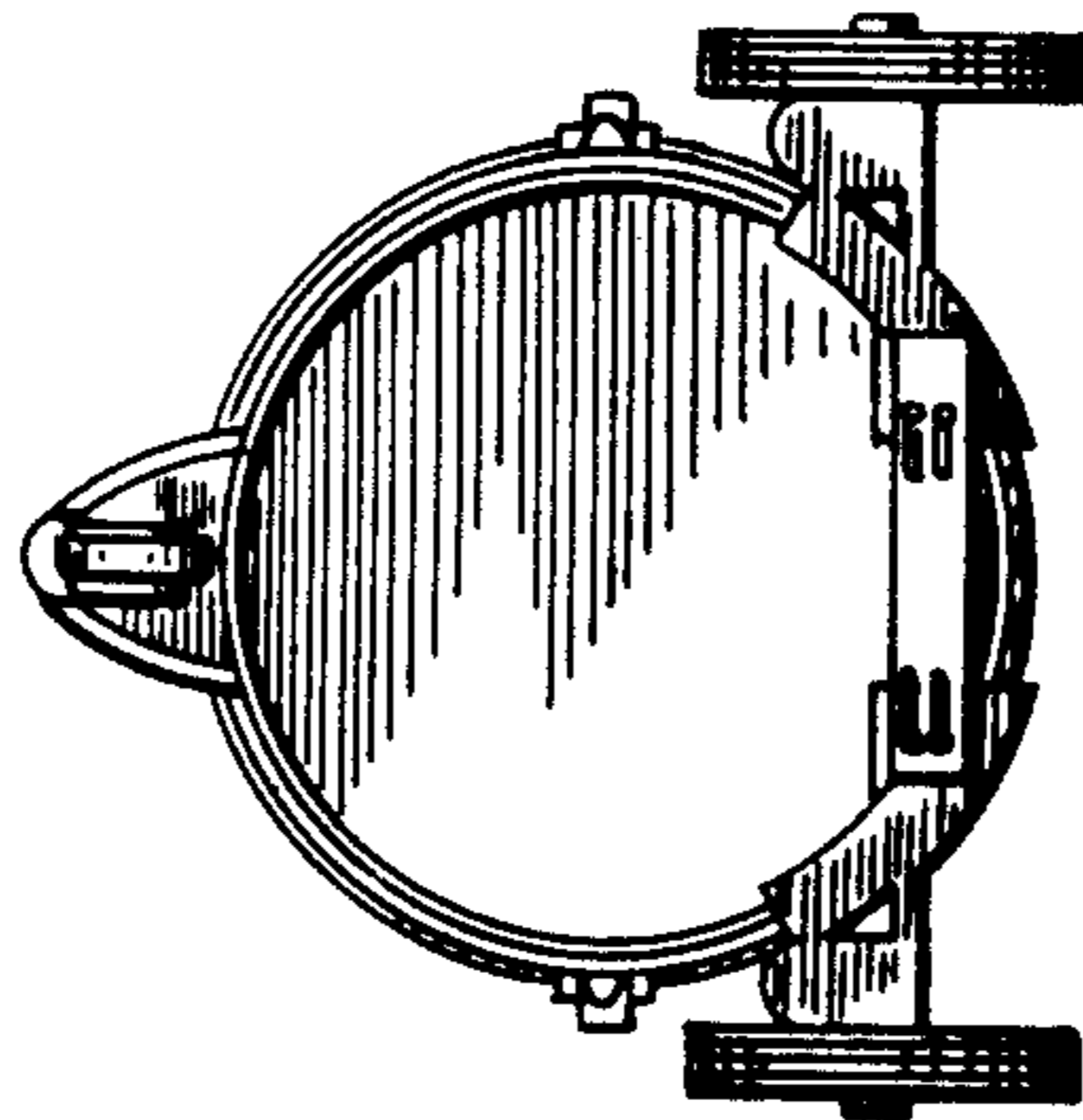
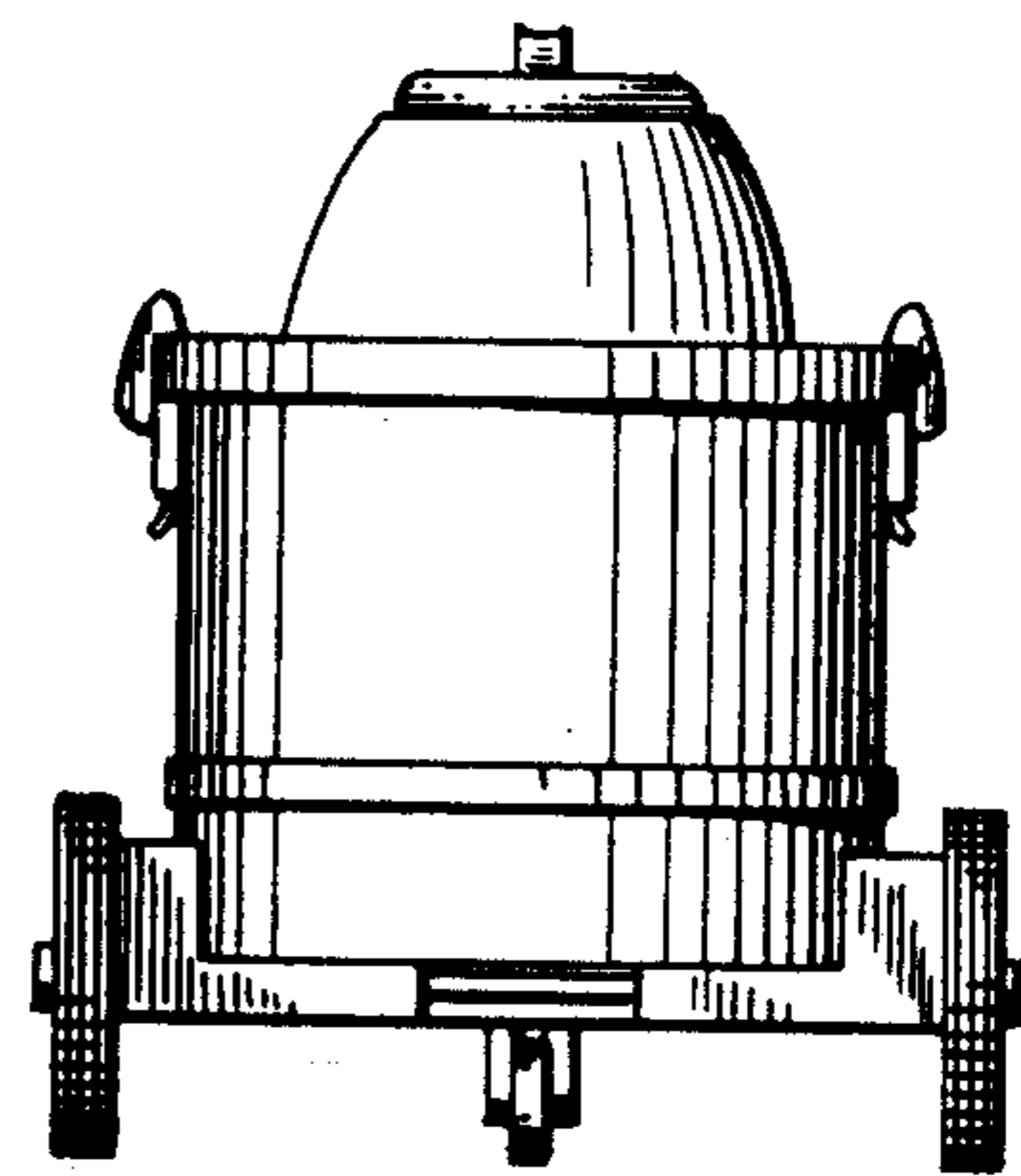
*Fig. 8.*



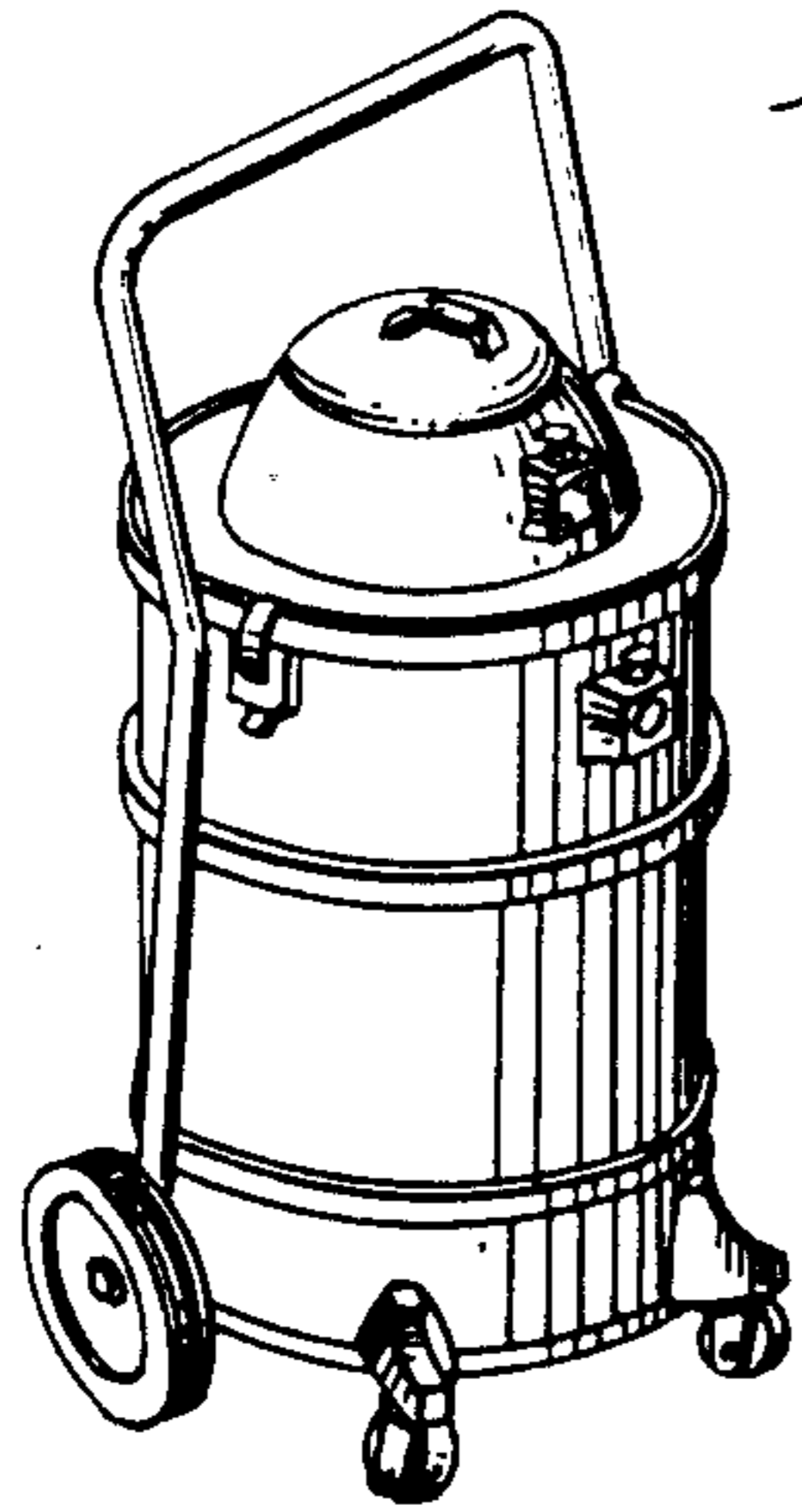
*Fig. 9.*



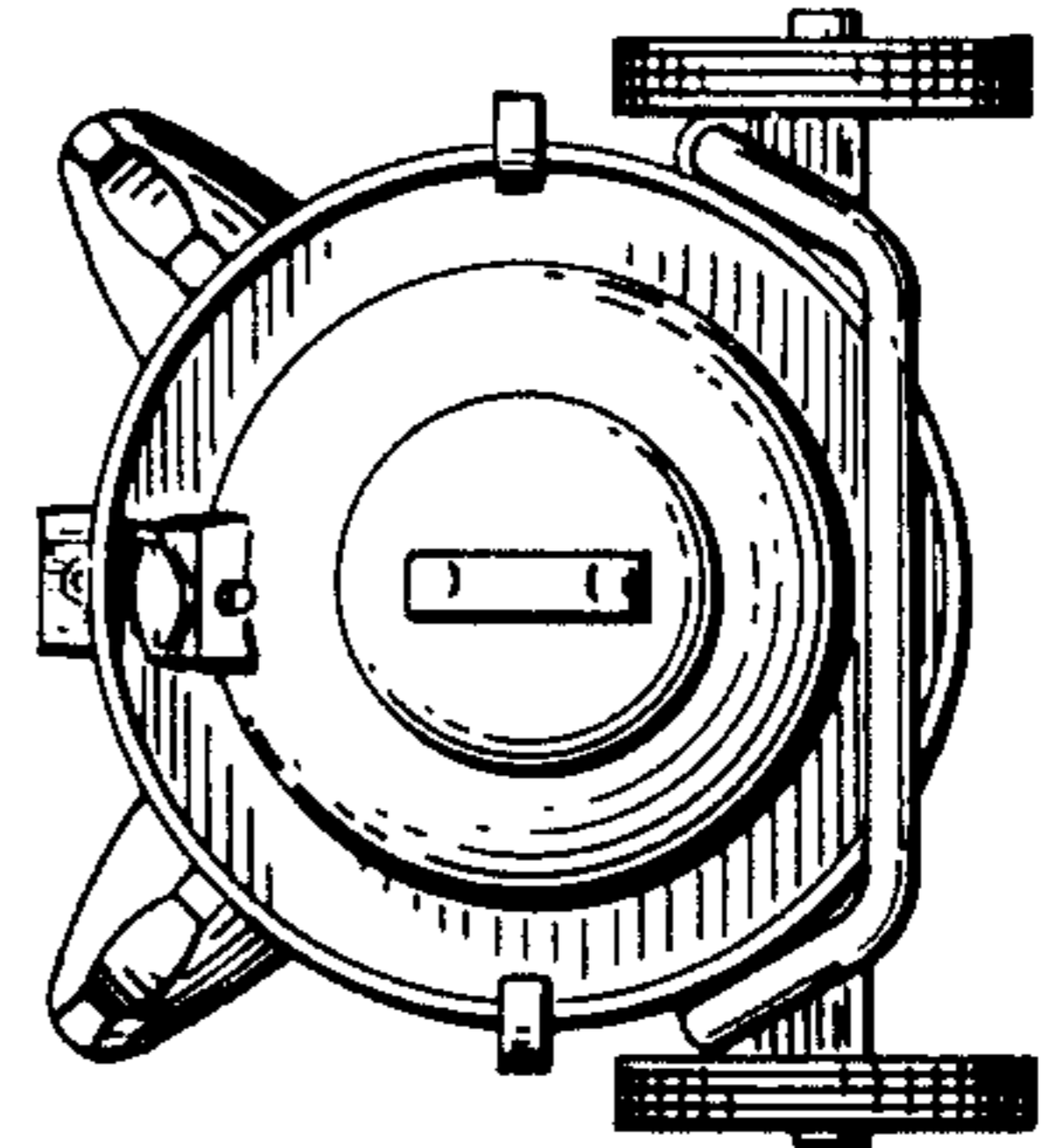
*Fig. 10.*



*Fig. 11.*

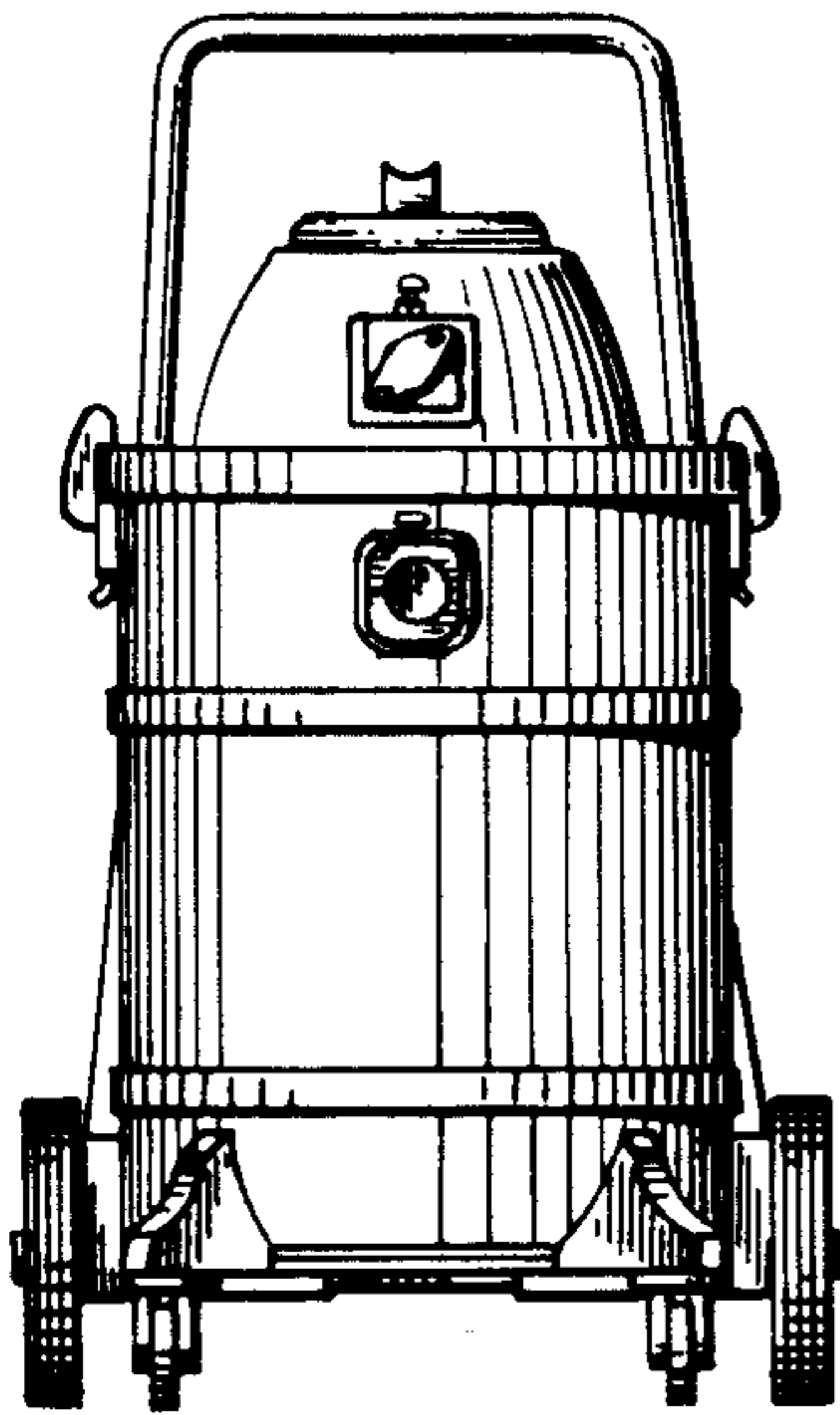


*Fig. 12.*

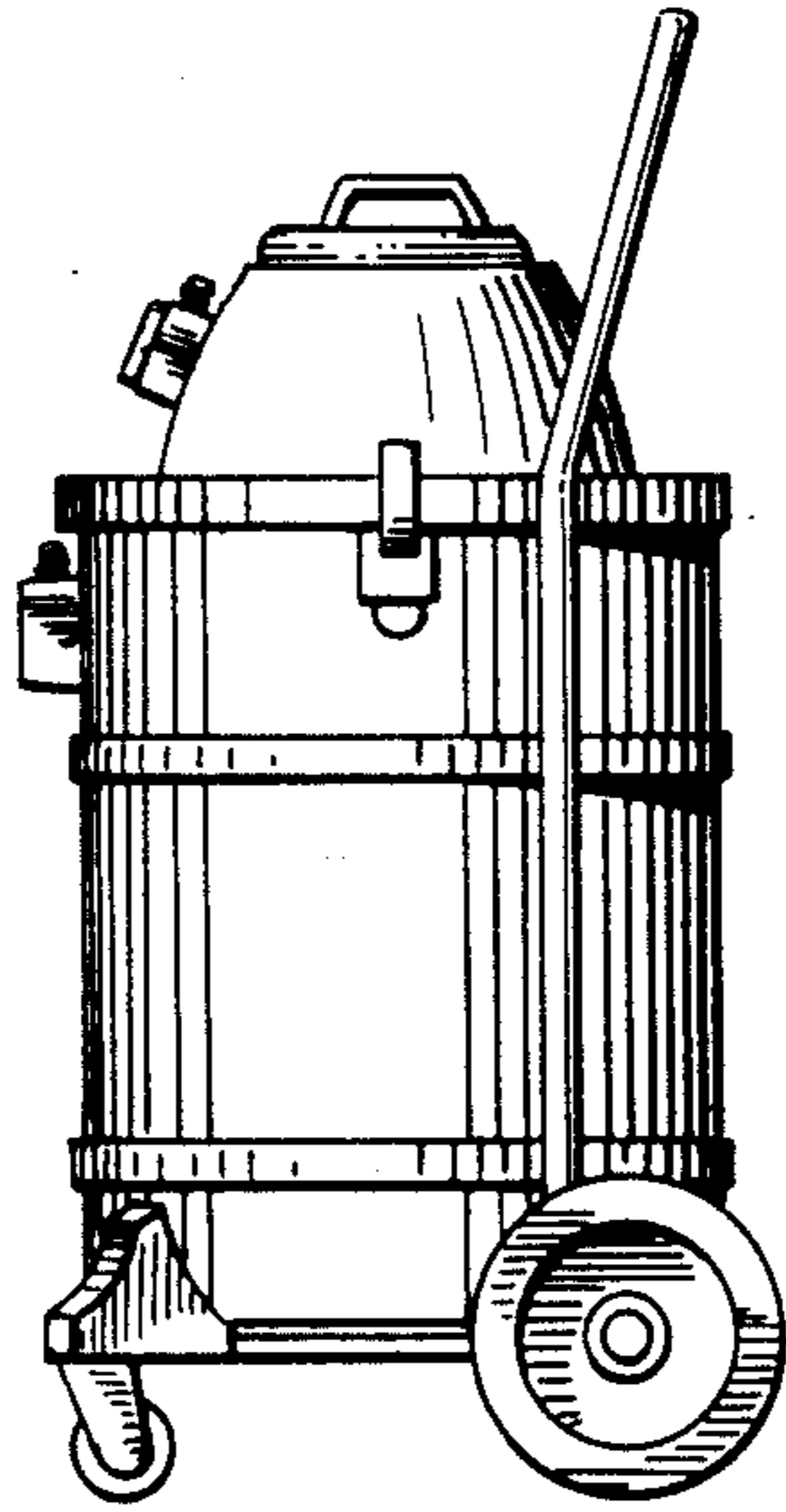


*Fig. 13.*

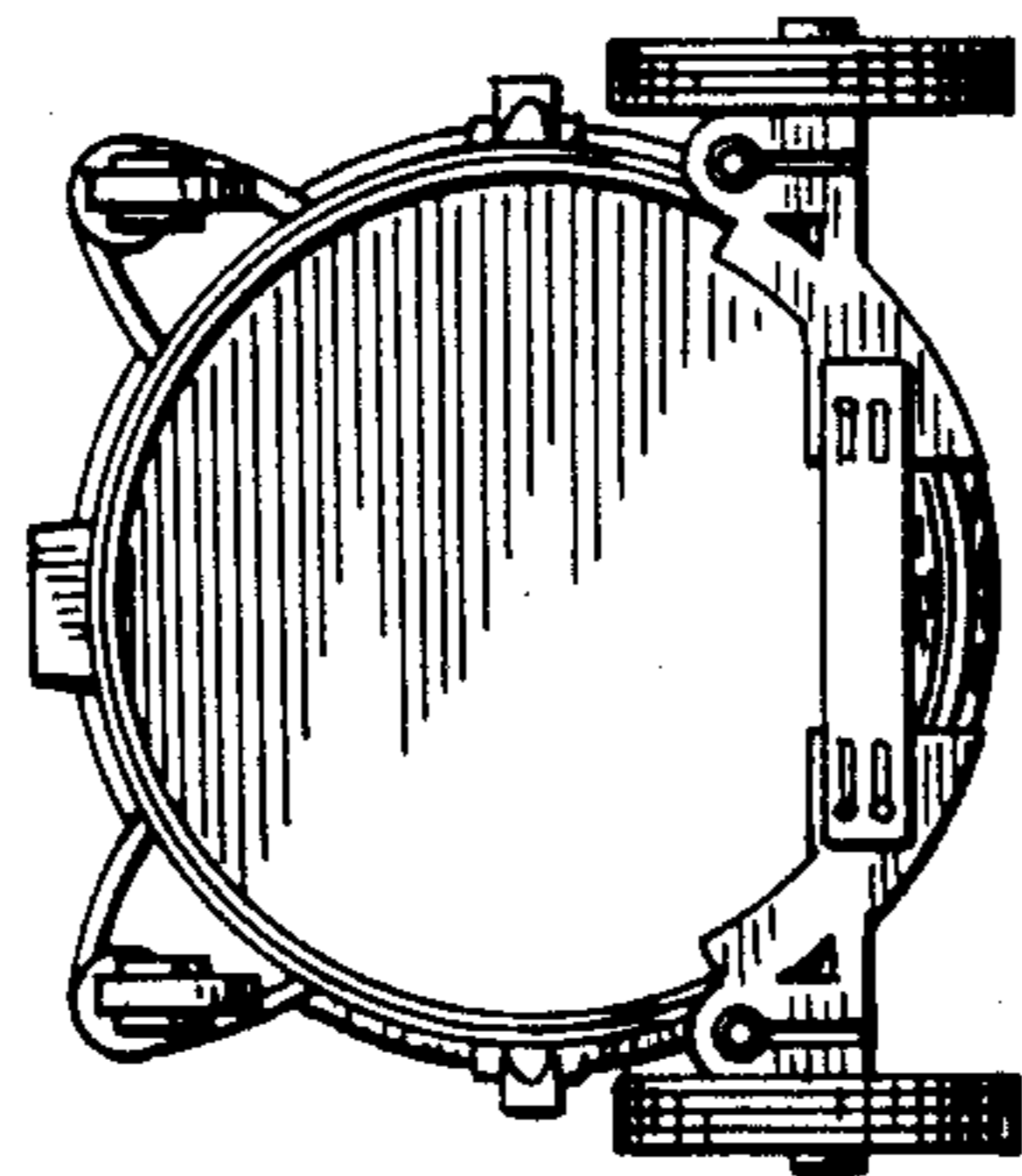
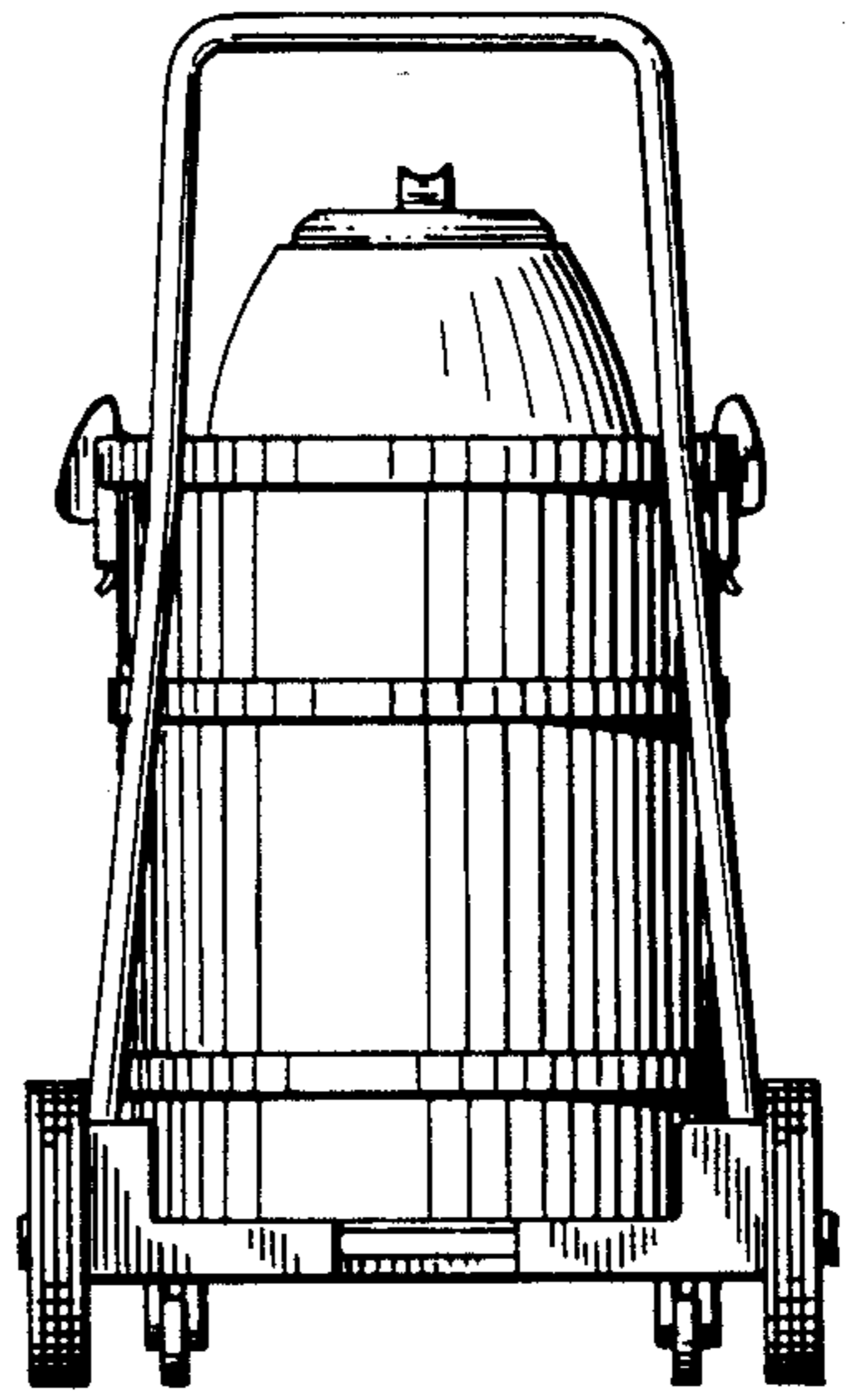
*Fig. 14.*



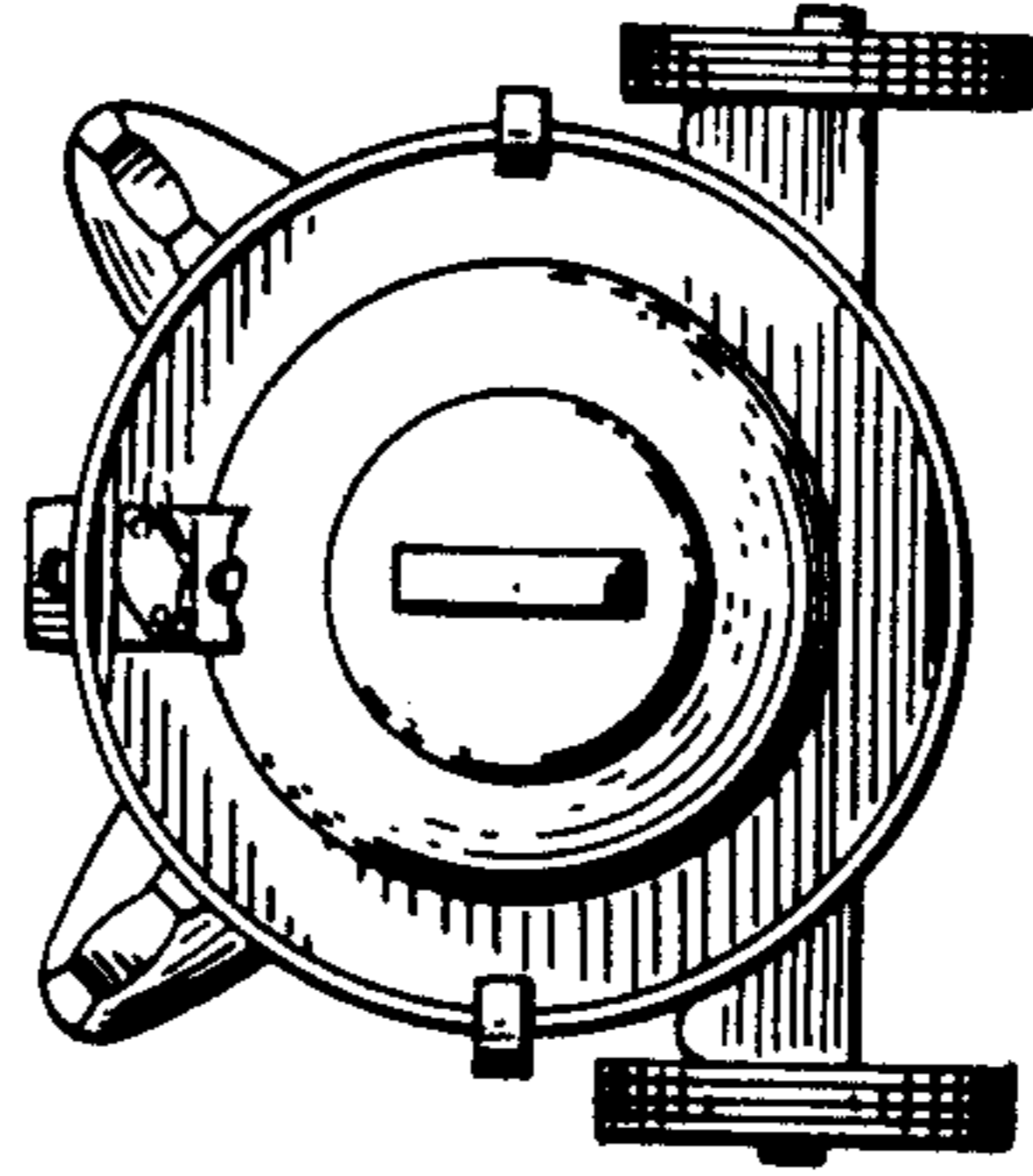
*Fig. 15.*



*Fig. 16.*

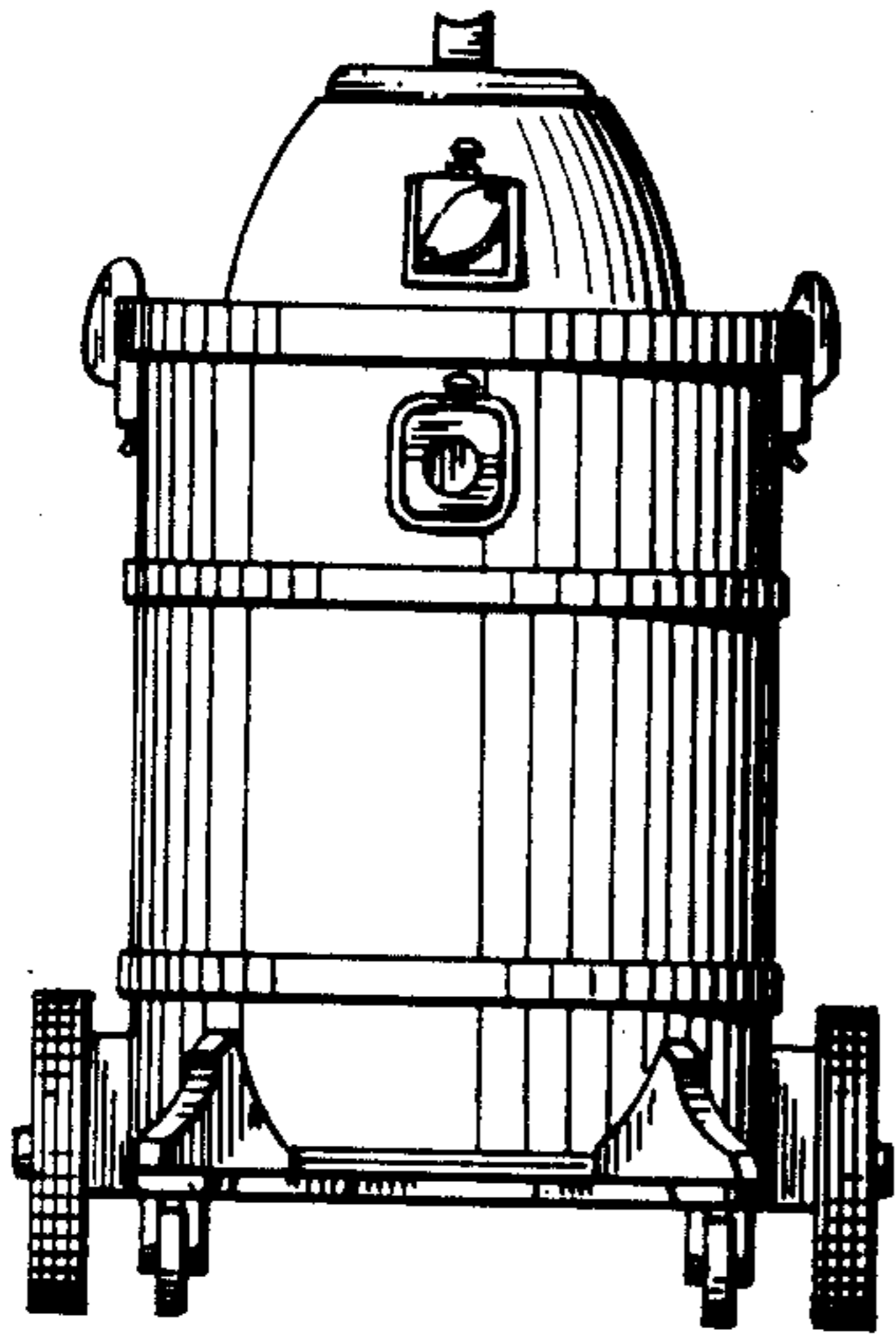


*Fig. 17.*

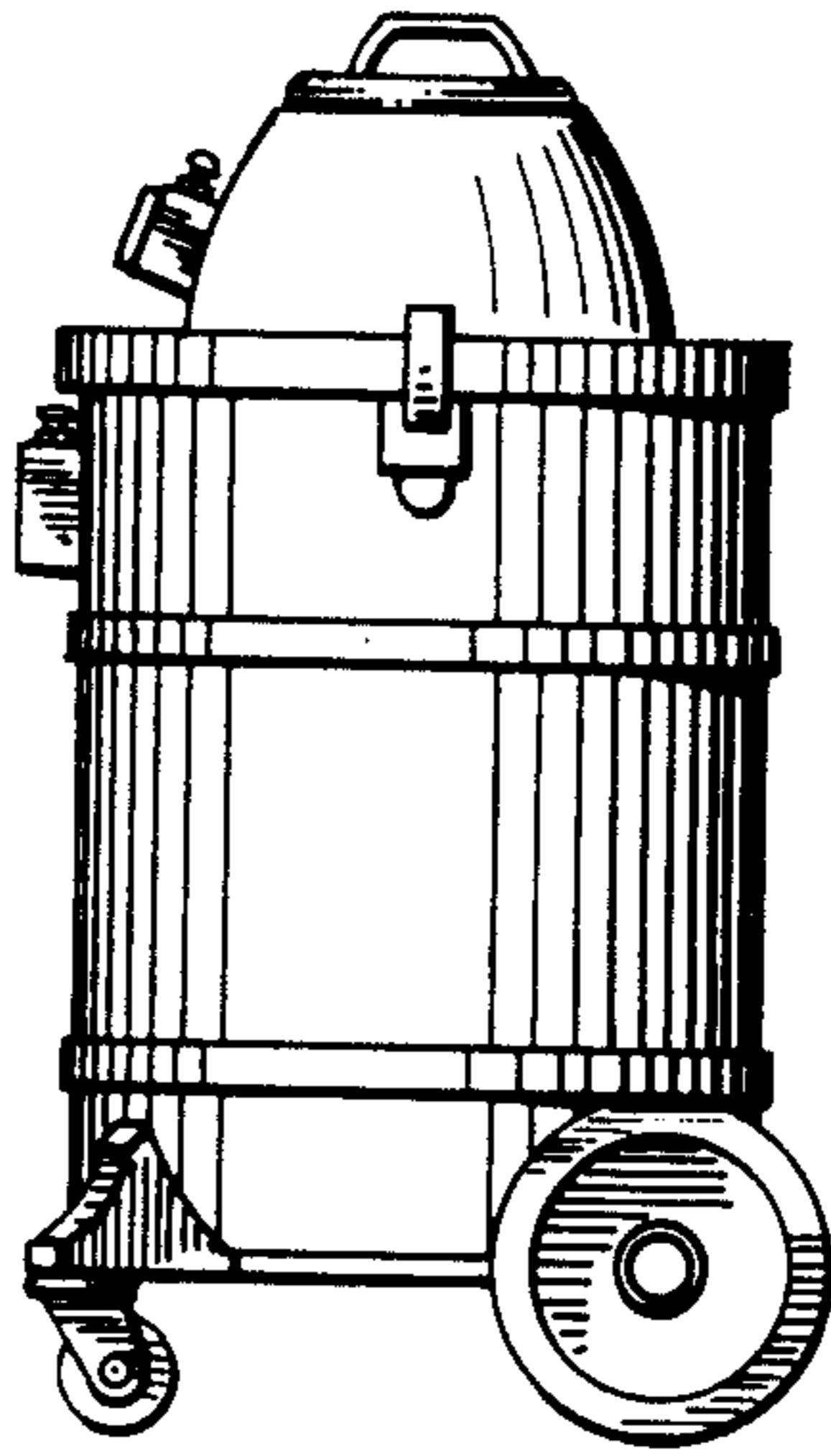


*Fig. 18.*

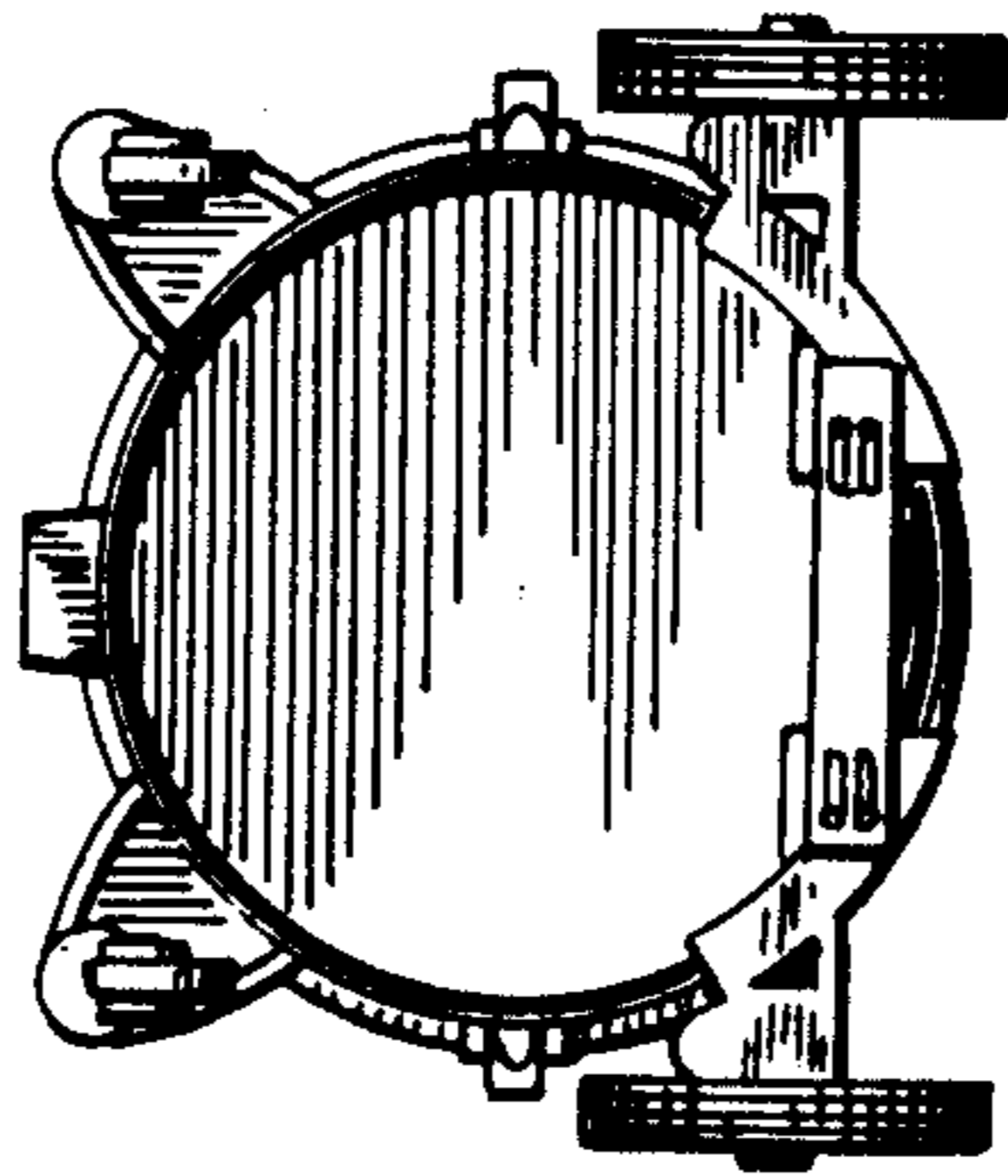
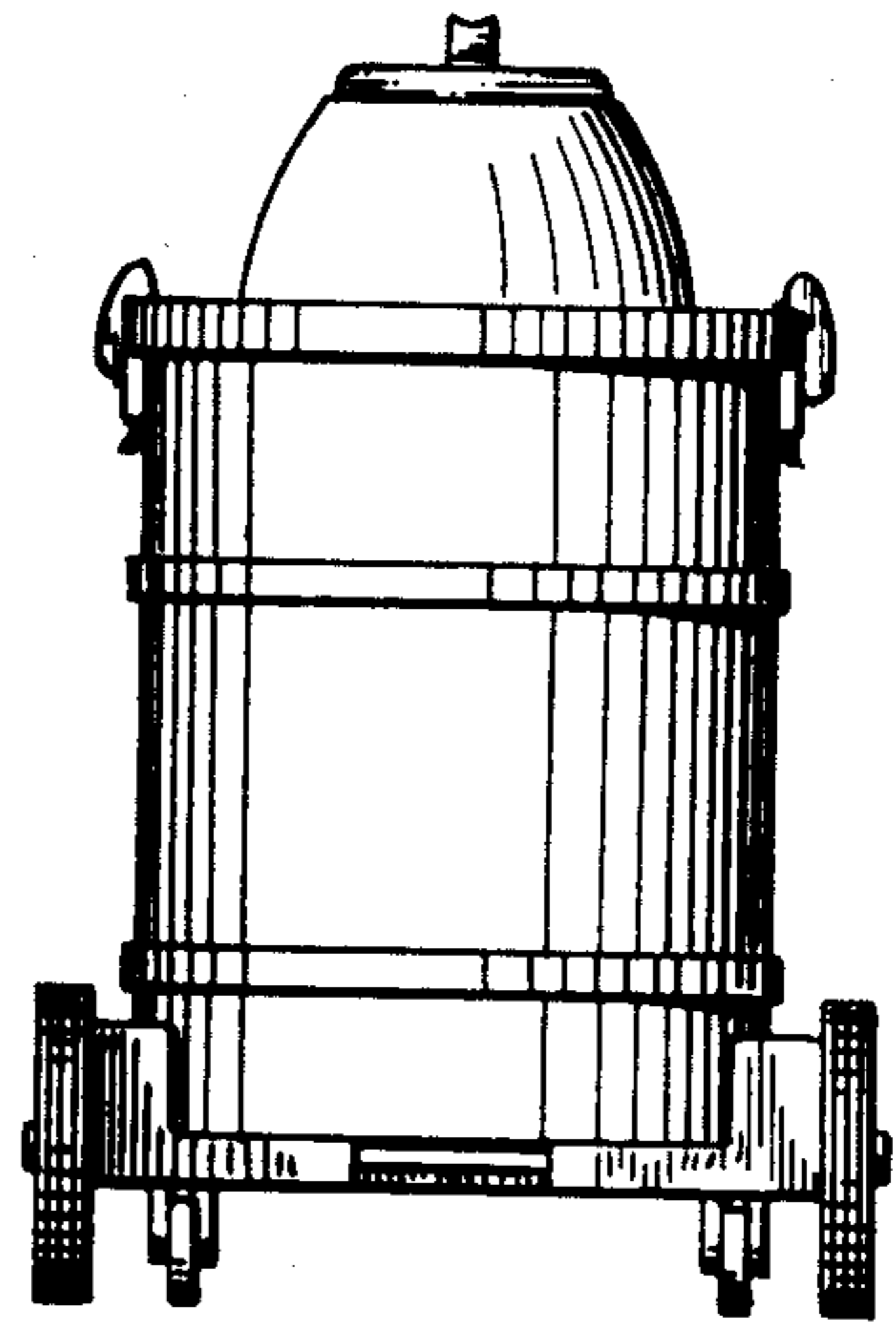
*Fig. 19.*



*Fig. 20.*

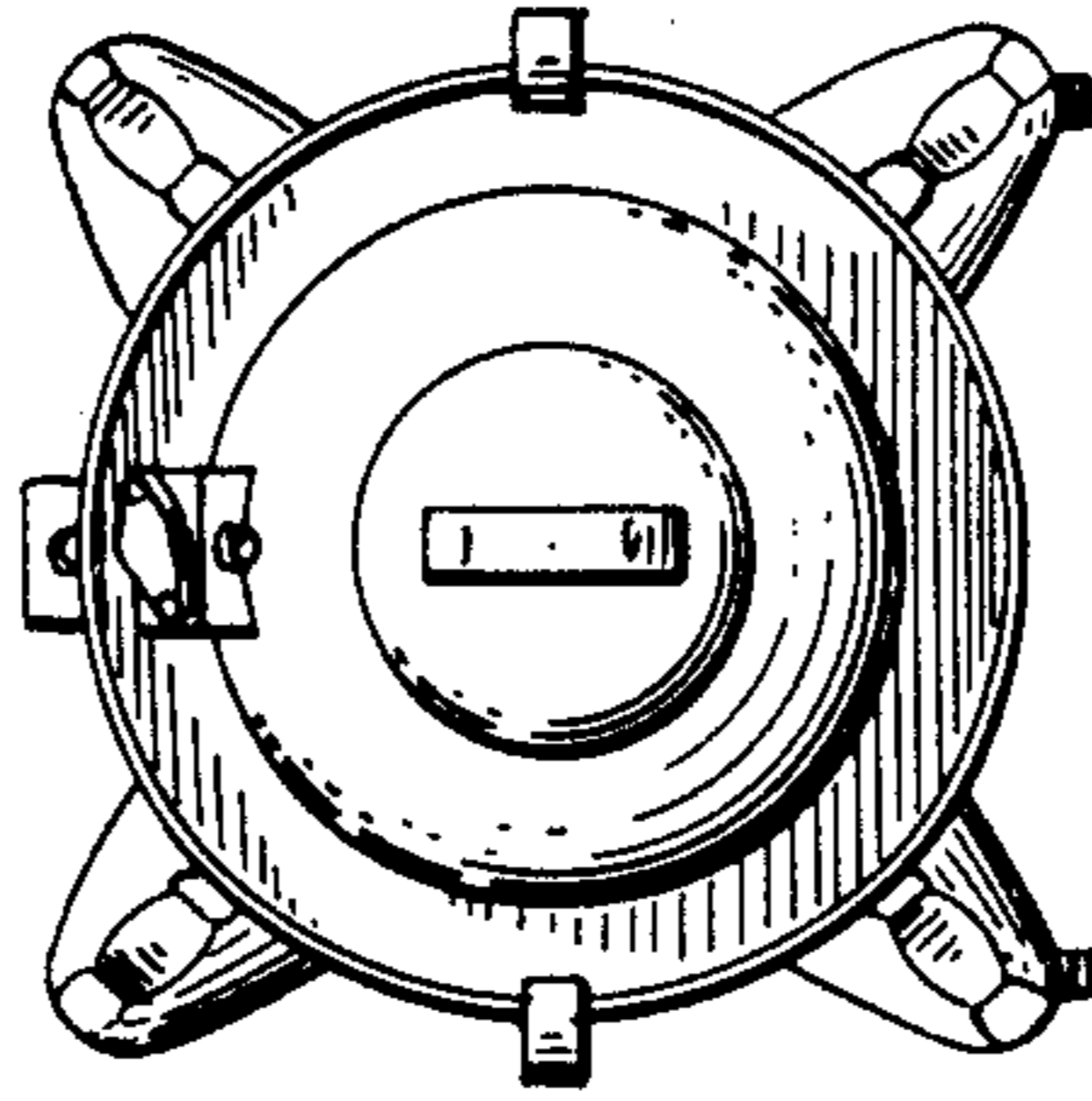


*Fig. 21.*

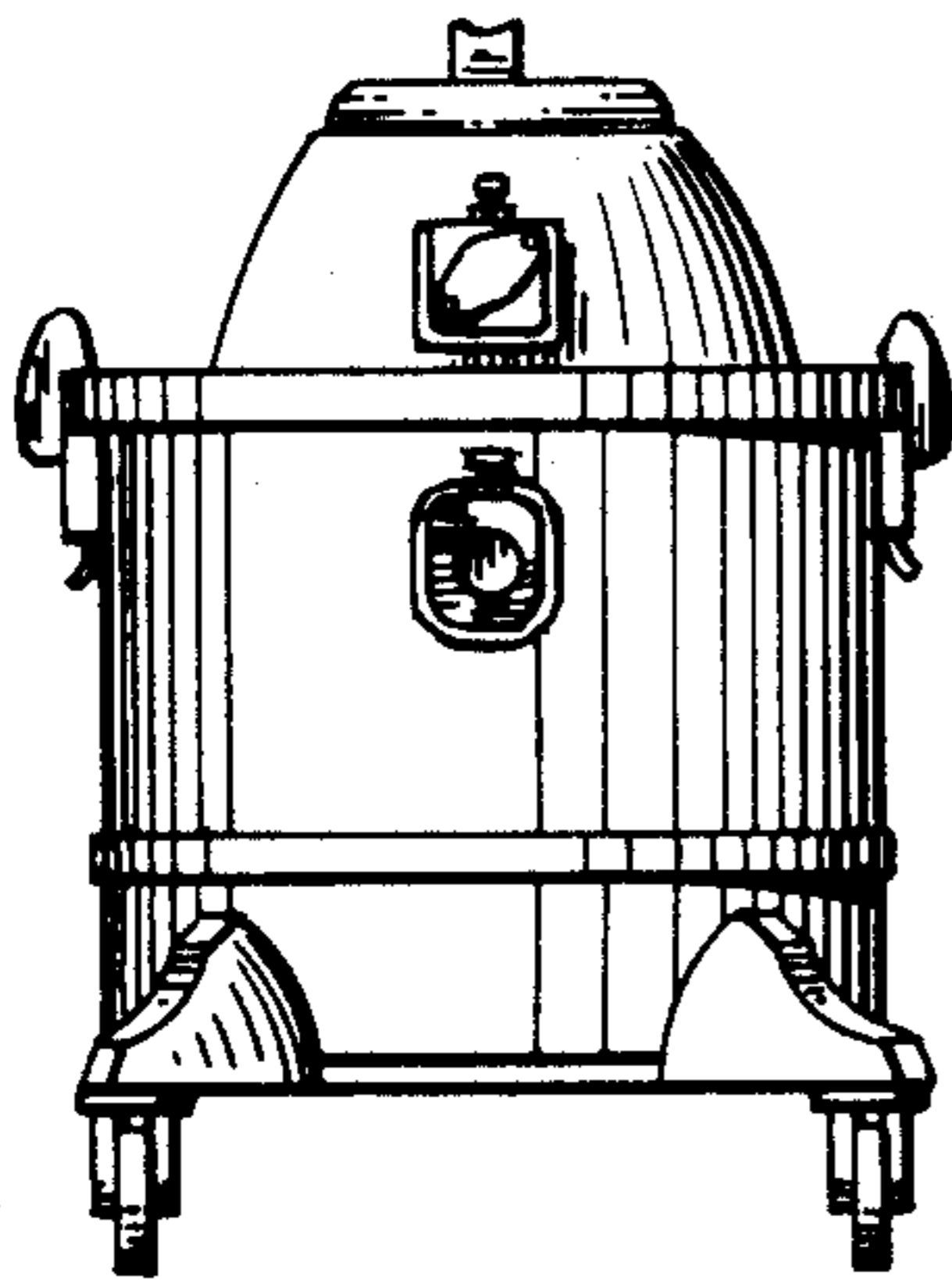


*Fig. 22.*

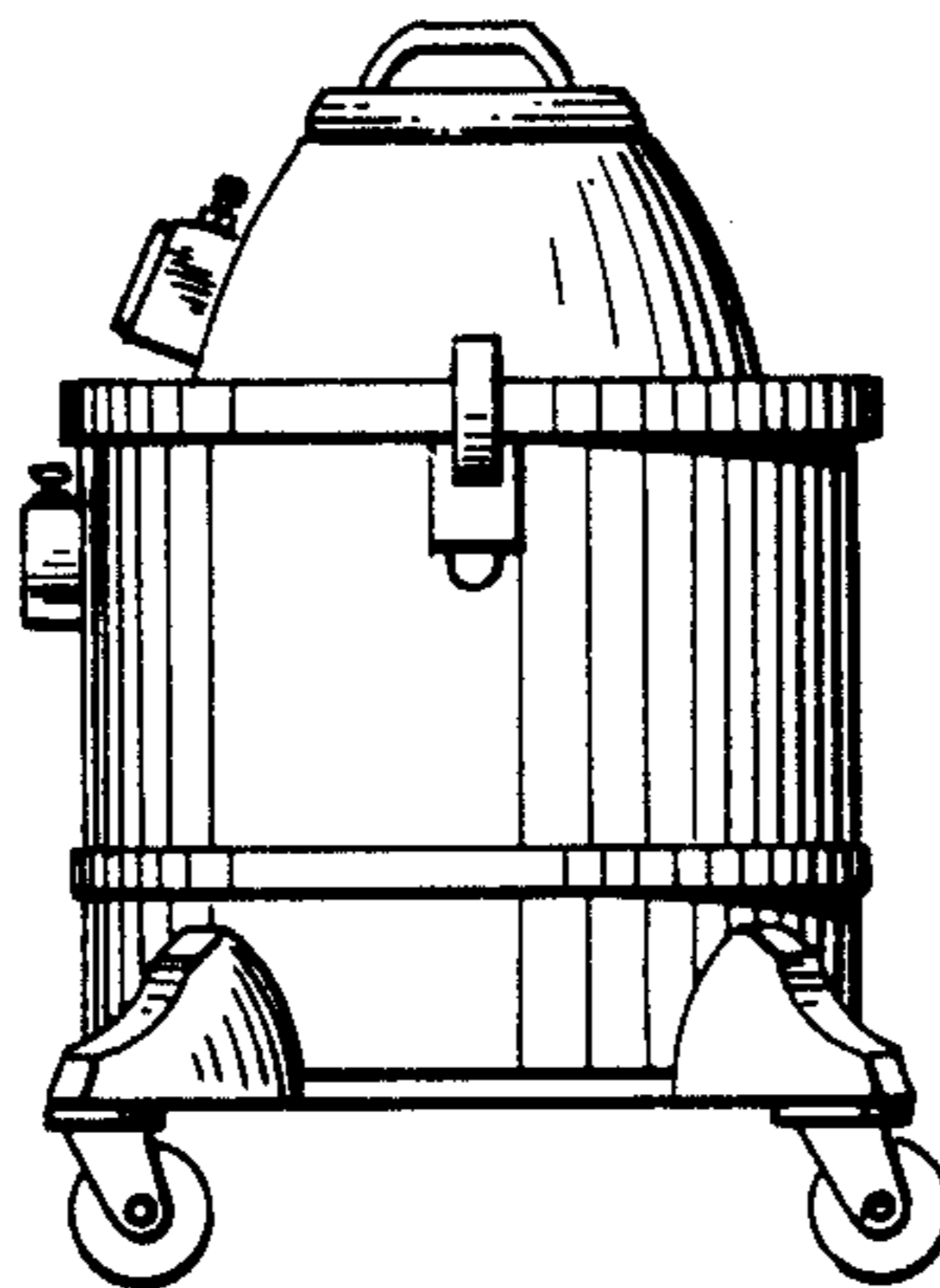
*Fig. 23.*



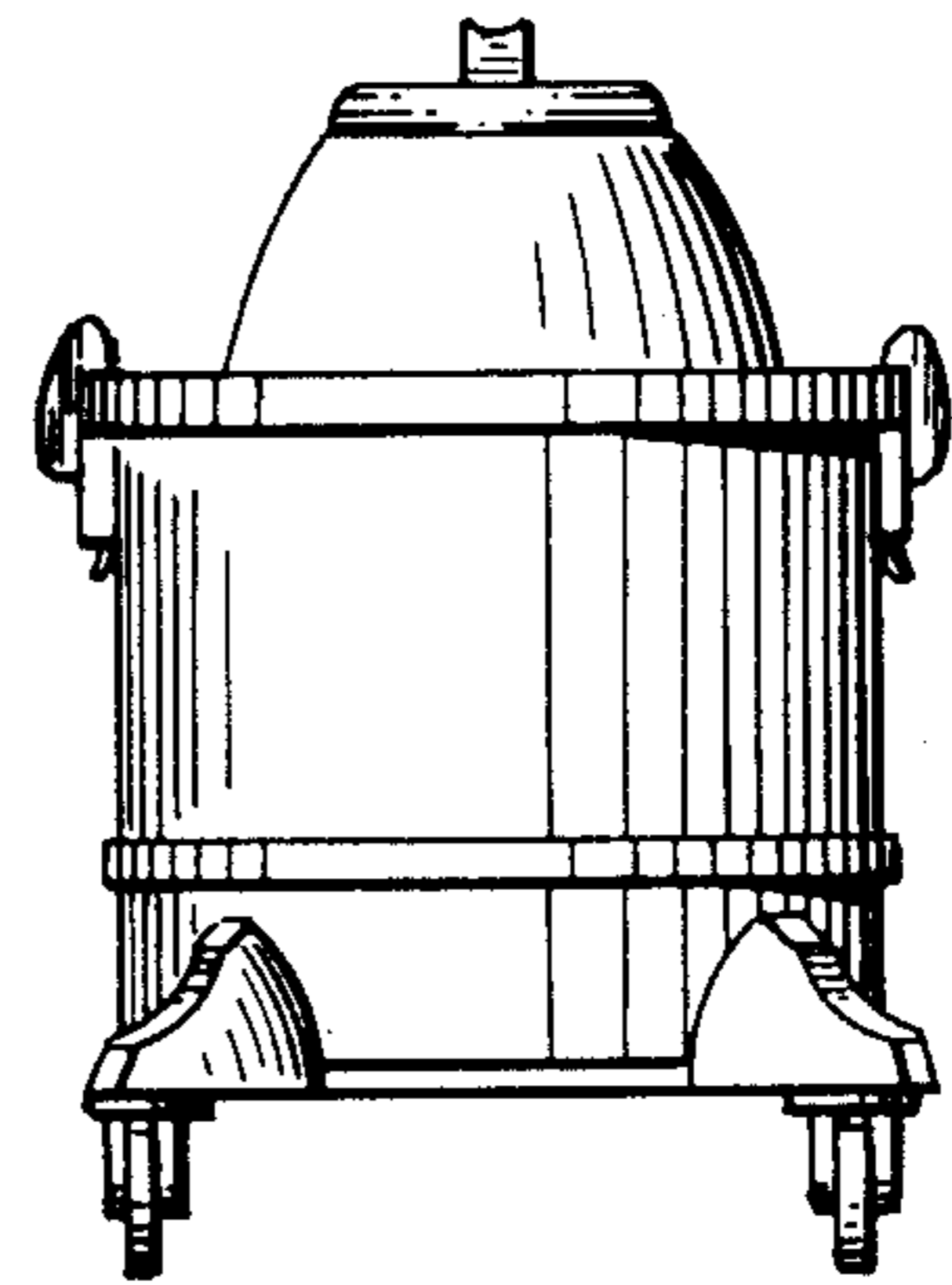
*Fig. 24.*



*Fig. 25.*



*Fig. 26.*



*Fig. 27.*

