

[54] GOLF BAG CLUB SEPARATOR

[76] Inventor: David E. Zopf, 2216 Marilyn Plz., Lansing, Mich. 48910

[**] Term: 14 Years

[21] Appl. No.: 882,962

[22] Filed: Mar. 2, 1978

[51] Int. Cl. D3-99

[52] U.S. Cl. D3/37

[58] Field of Search D3/37; D25/74-75; D8/354, 371; 220/22; D9/184; 150/1.5 R; D7/129; 52/730

[56] References Cited

U.S. PATENT DOCUMENTS

D. 214,332	6/1969	Swett	D7/129
2,478,621	8/1949	Attula	220/22
3,391,816	7/1968	Swett	D9/184
3,842,876	10/1974	Cristelli	150/1.5 R
3,960,637	6/1976	Ostrow	52/730

Primary Examiner—Louis S. Zarfes

Assistant Examiner—George P. Word
Attorney, Agent, or Firm—Miller, Morriss and Pappas

[57] CLAIM

The ornamental design for a golf bag club separator, as shown and described.

DESCRIPTION

FIG. 1 is a perspective view of a golf bag club separator showing my new design.

FIG. 2 is a top plan view thereof;

FIG. 3 is a side elevational view thereof; the opposite side being a mirror image thereof.

FIG. 4 is a front elevational view thereof, the opposite side being a mirror image thereof.

FIG. 5 is a perspective view of a modified form of the golf bag club separator.

FIG. 6 is a top plan view thereof;

FIG. 7 is a front elevational view, the opposite side being a mirror image thereof;

FIG. 8 is a perspective view of another modified form of the golf bag club separator; and

FIG. 9 is a cross-sectional view taken along line 9—9 of FIG. 8.

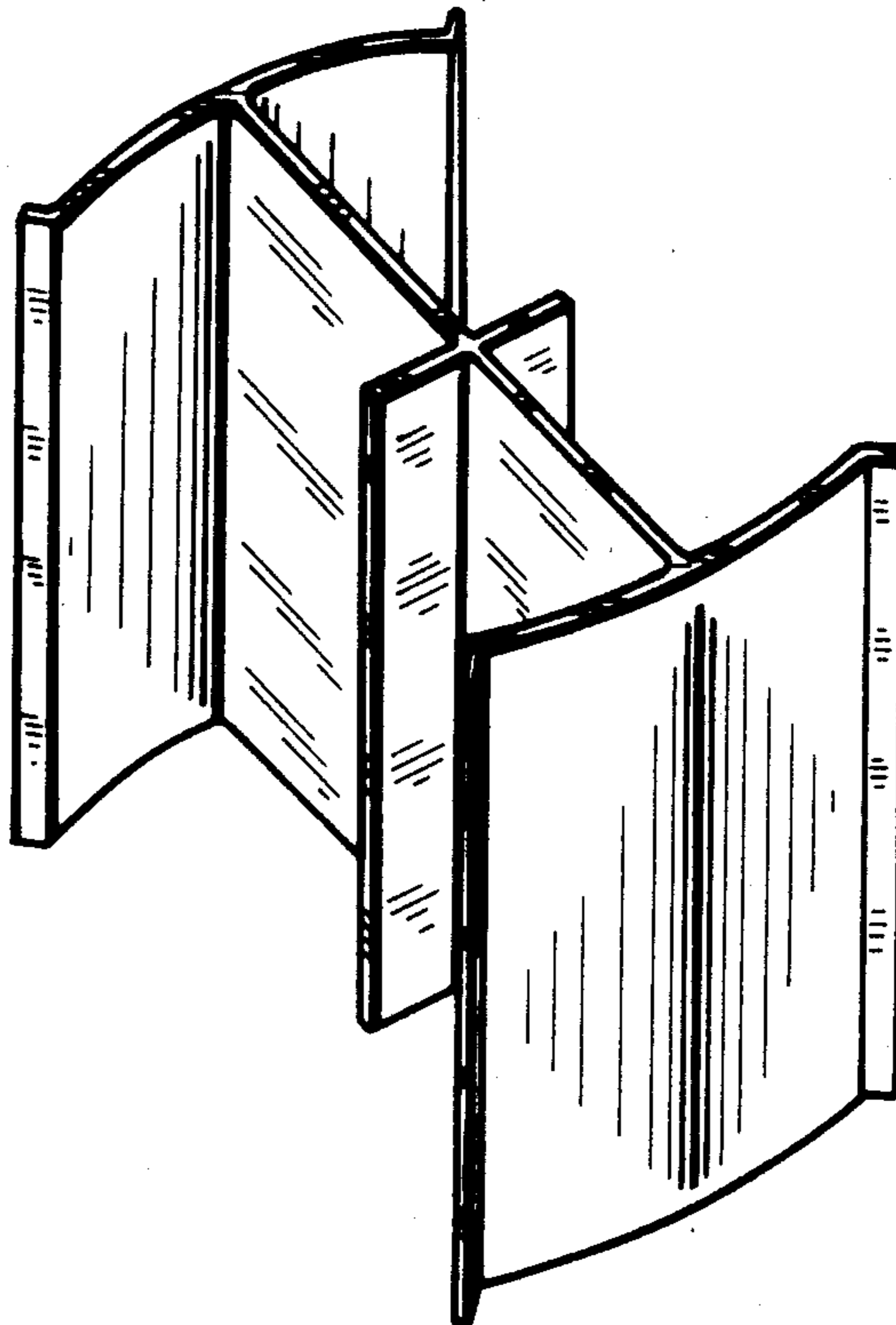

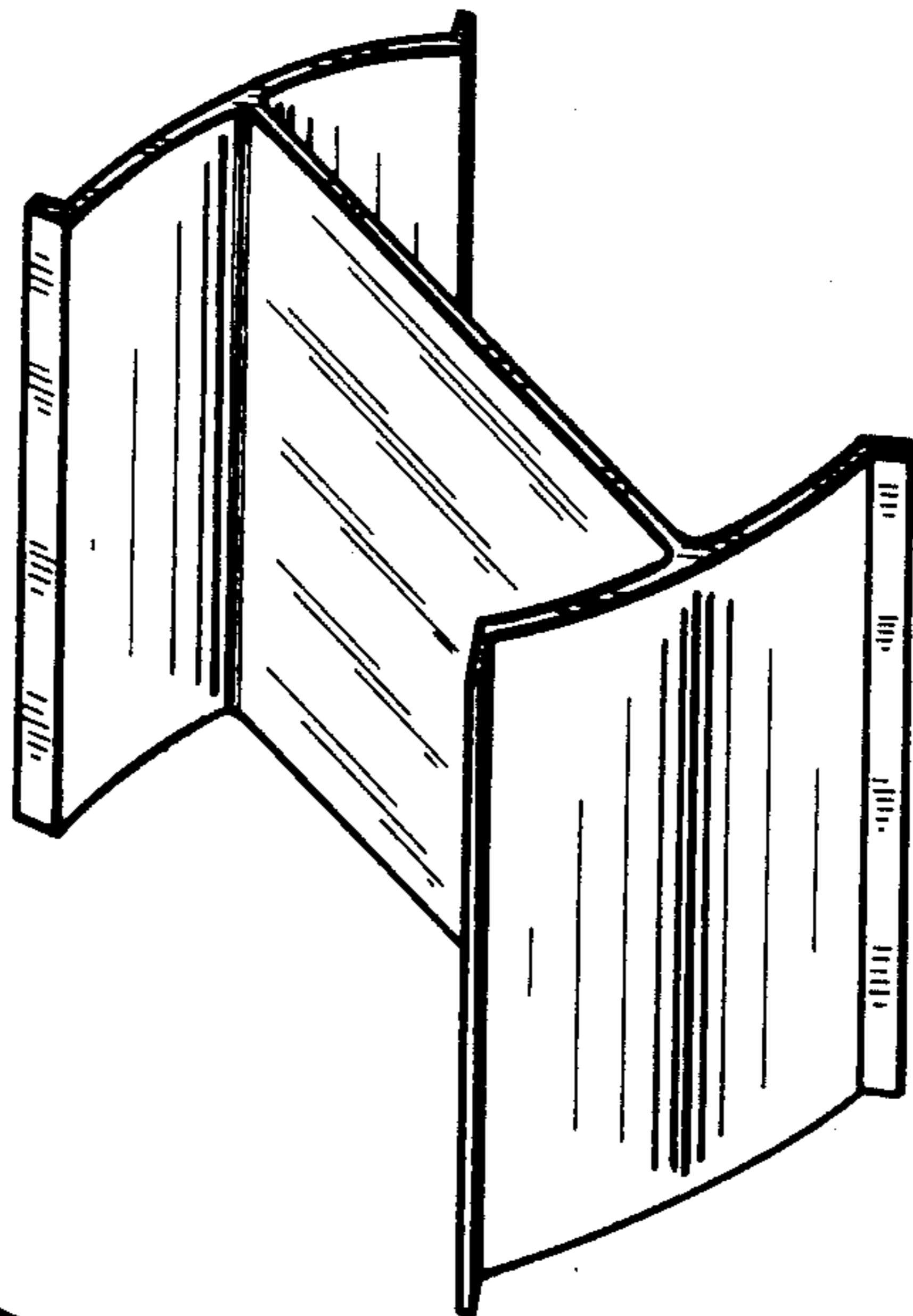

—FIG. 1

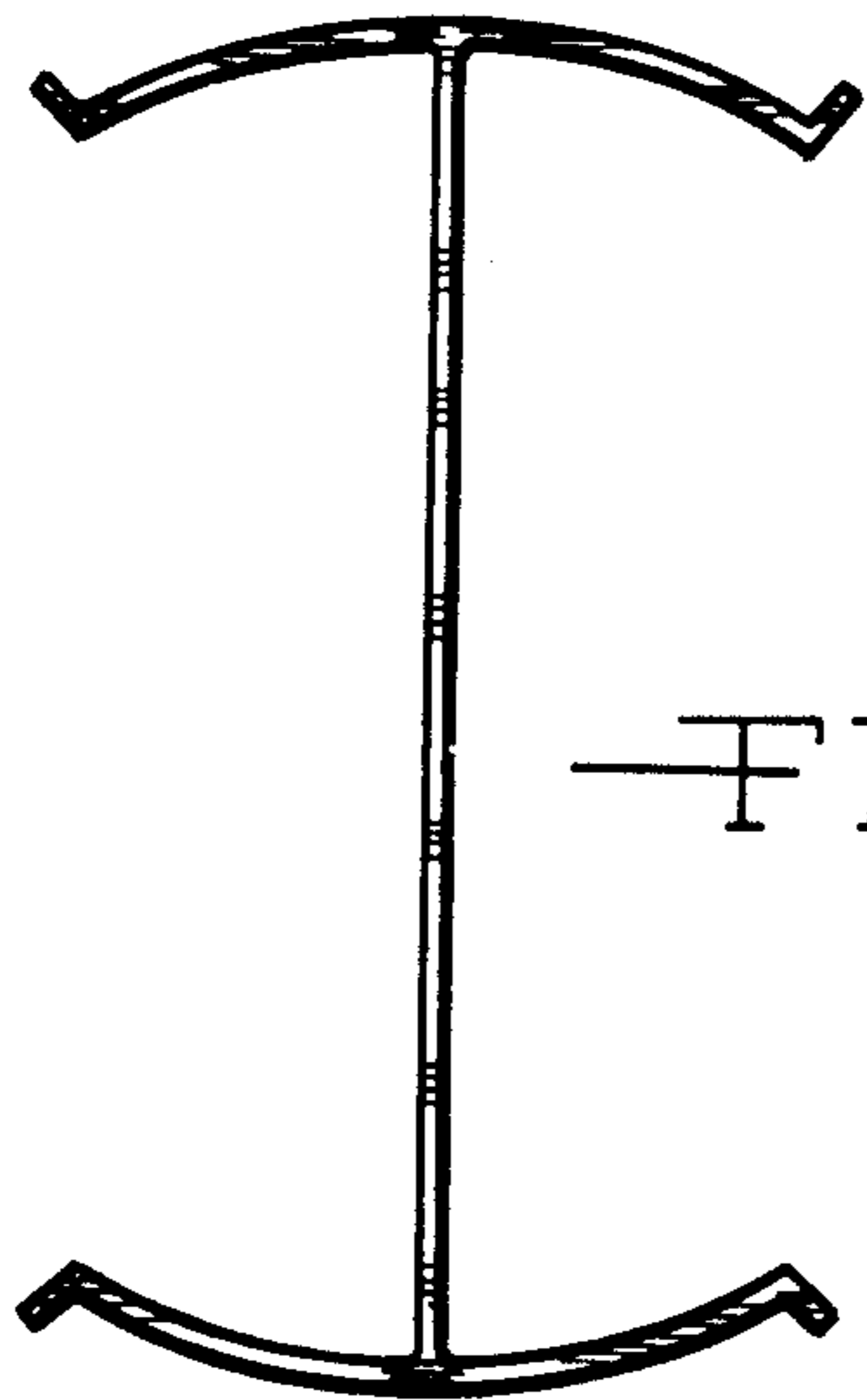

—FIG. 2

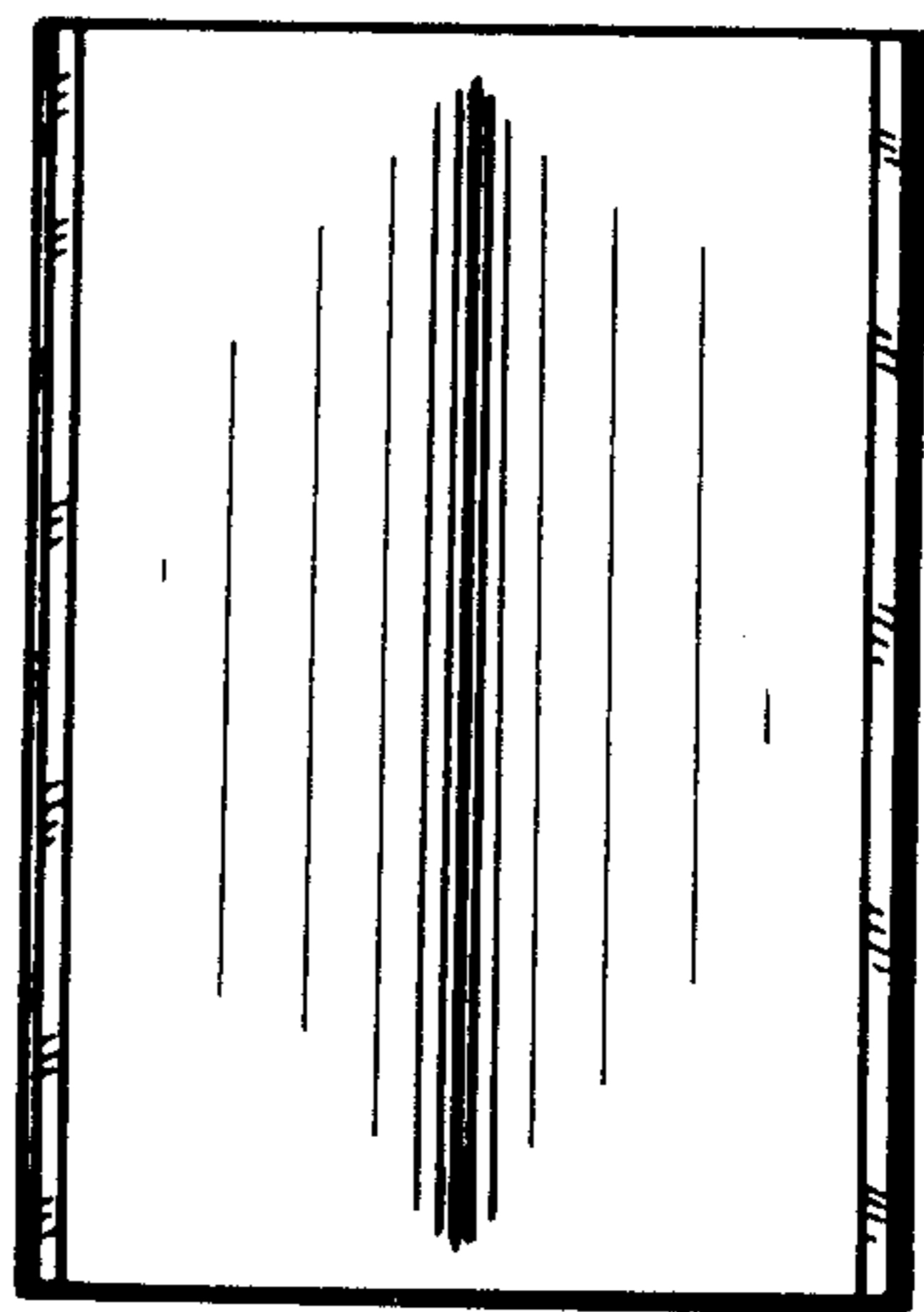

—FIG. 3

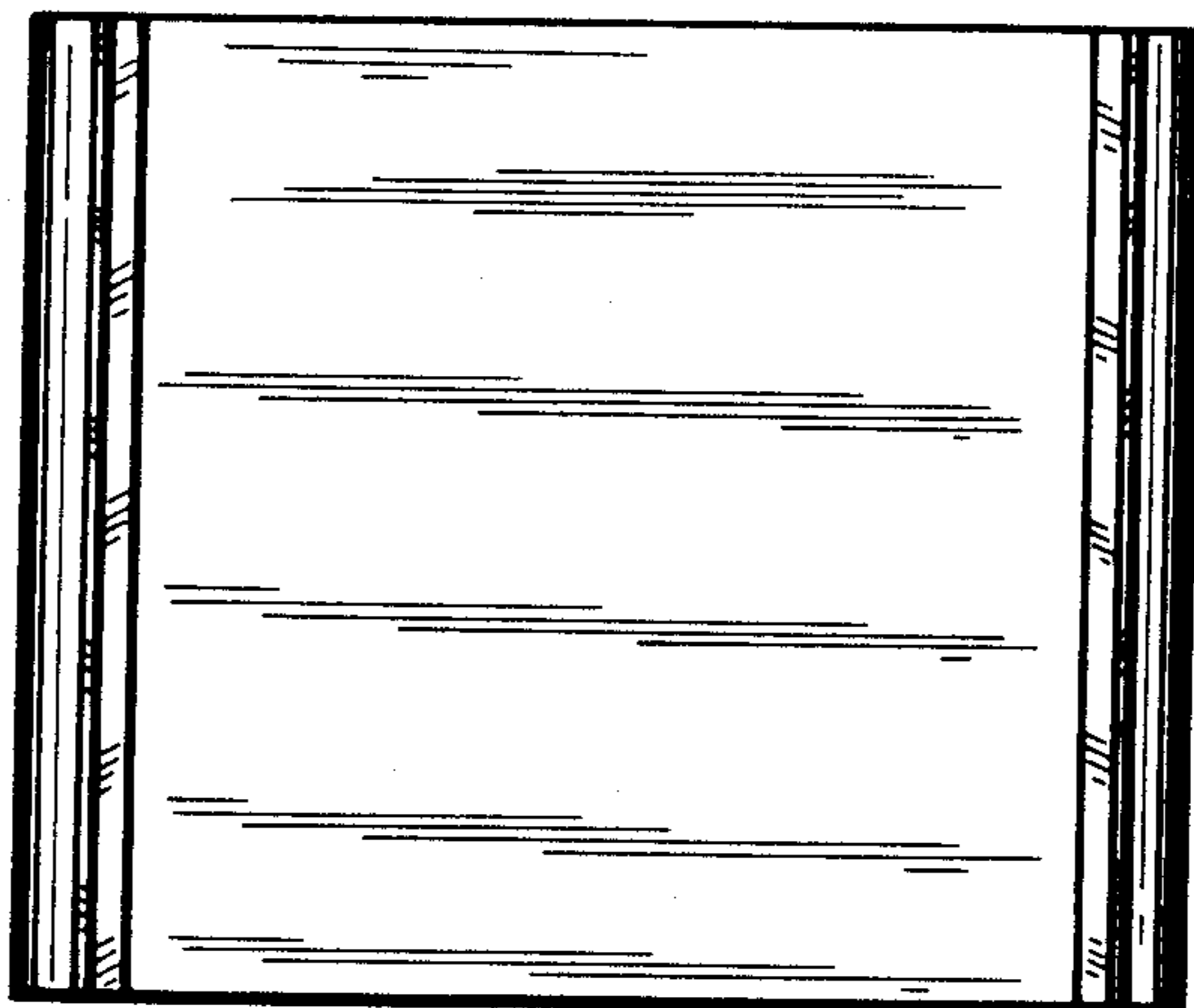

—FIG. 4

FIG. 5

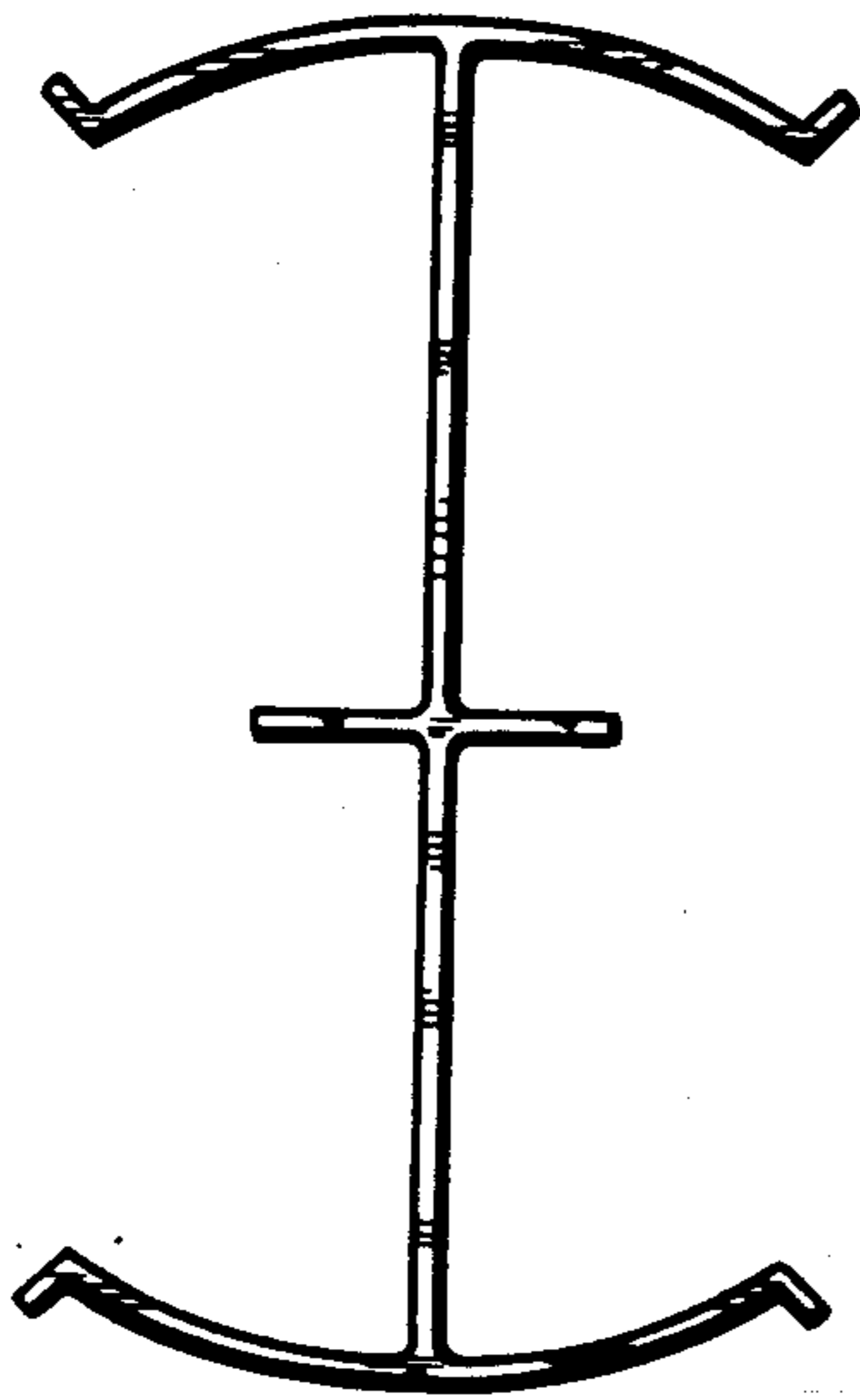
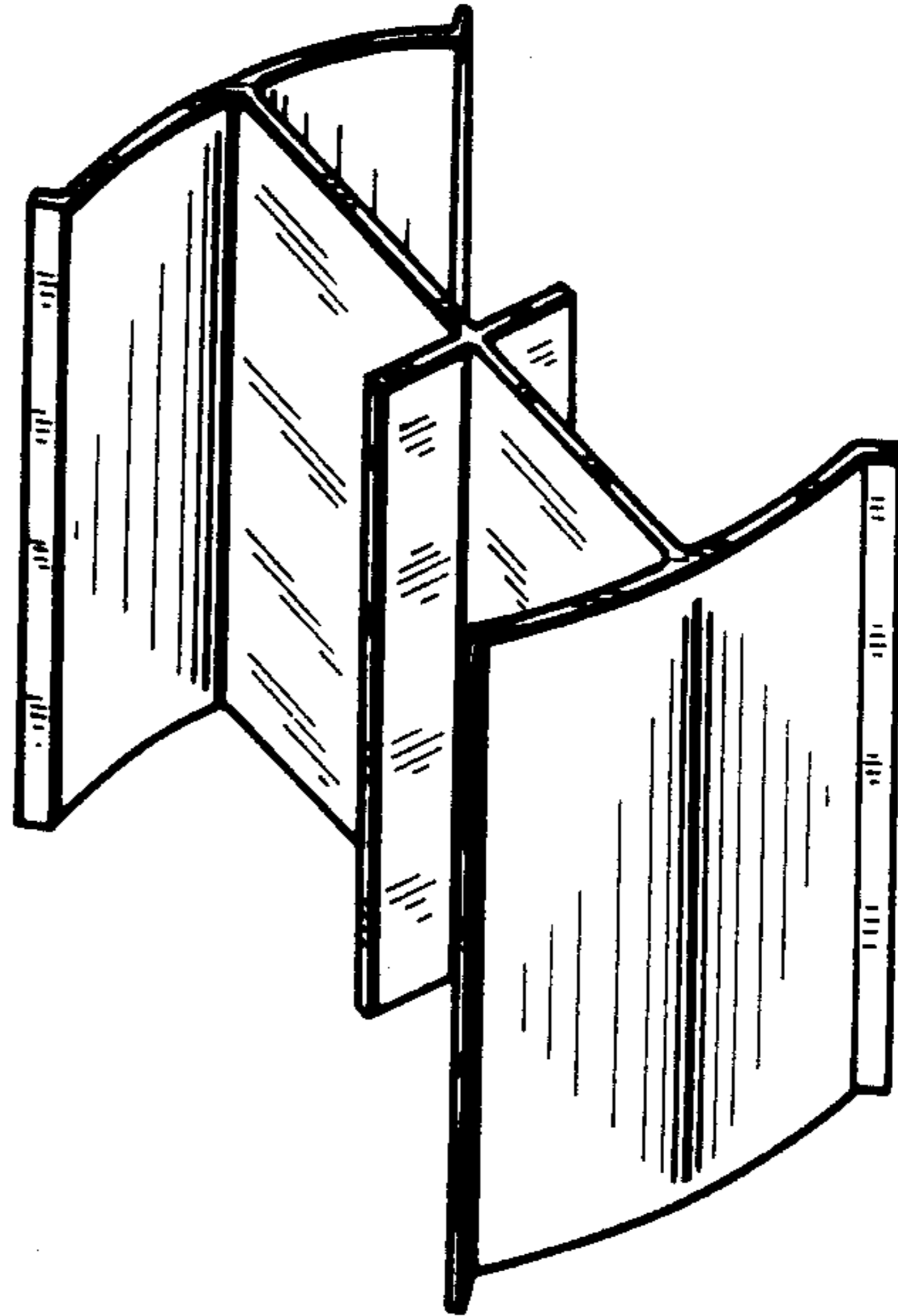
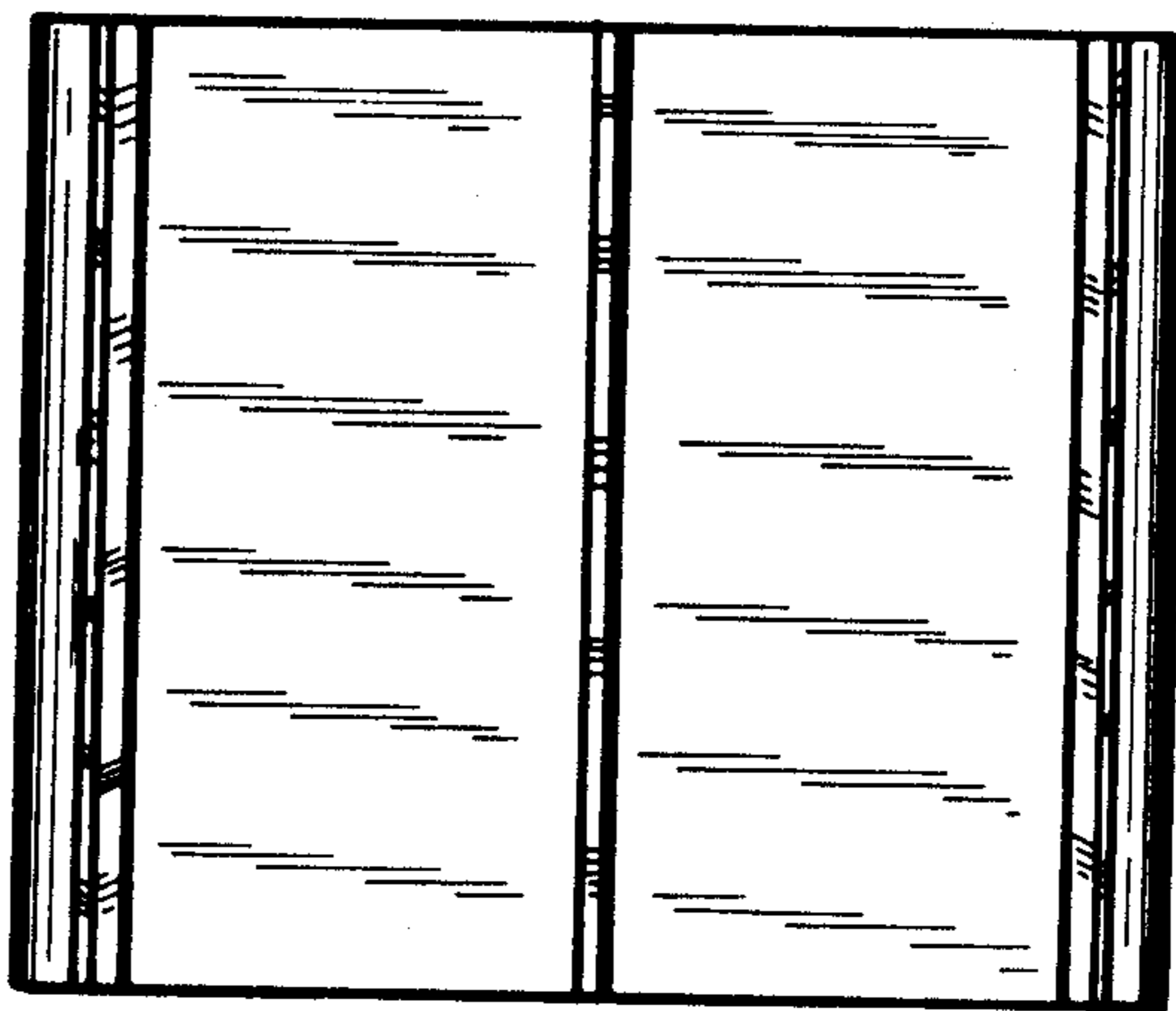

FIG. 6

FIG. 7



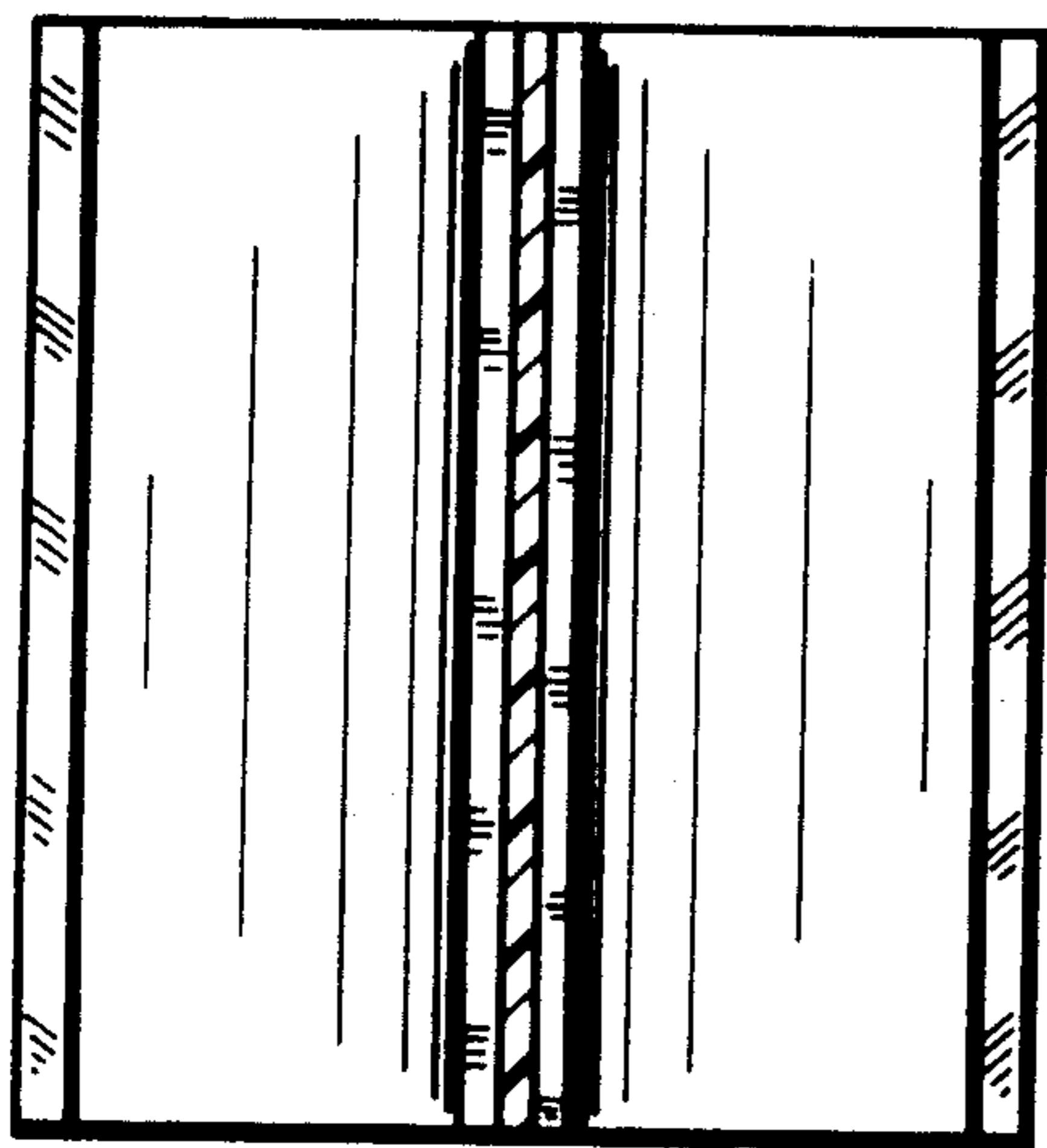
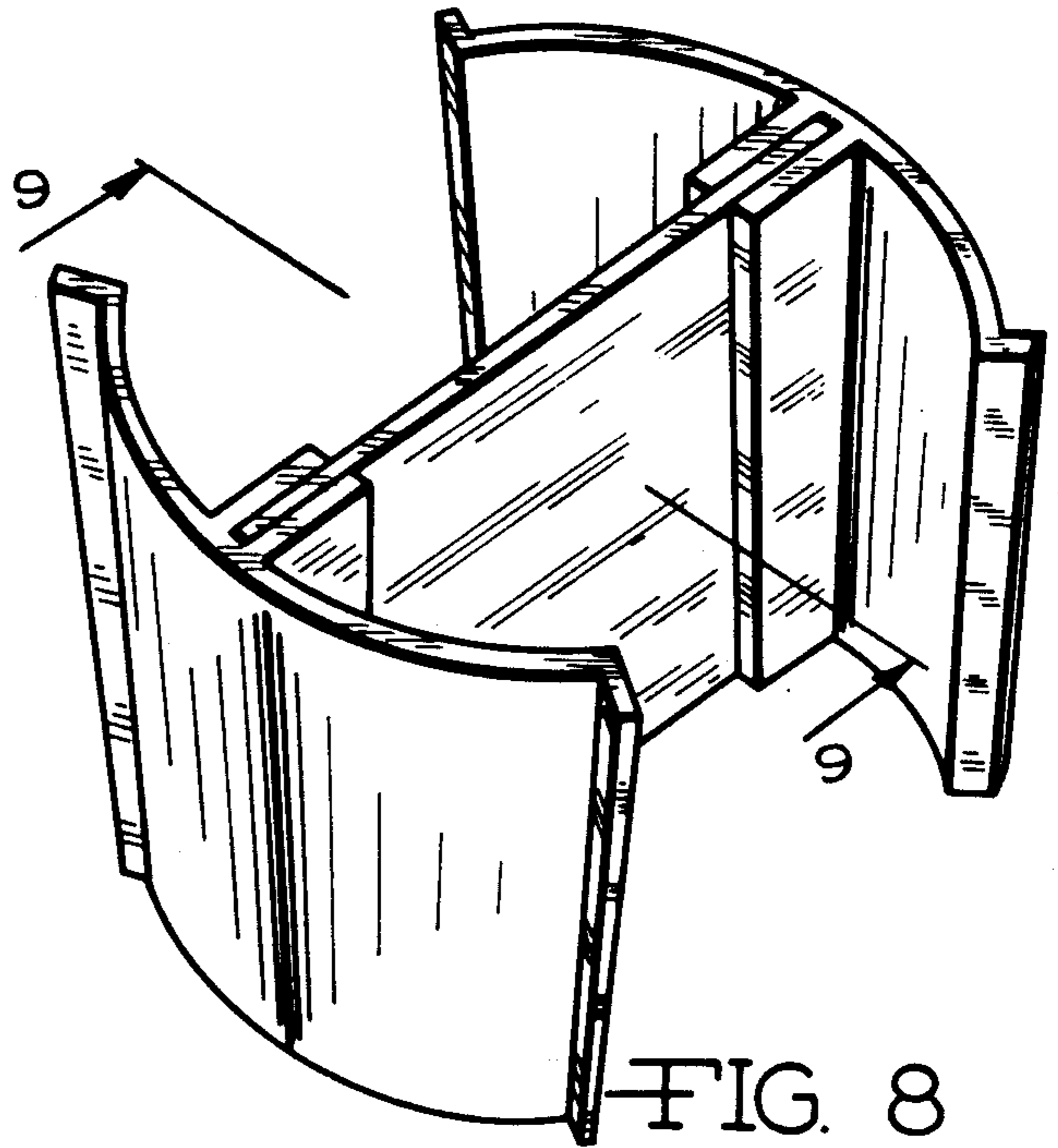

FIG. 9