

[54] BINDER

[75] Inventor: Rune Olsson, Hollviksnas, Sweden

[73] Assignee: Produnik AB, Sweden

[**] Term: 14 Years

[21] Appl. No.: 821,095

[22] Filed: Aug. 2, 1977

[30] Foreign Application Priority Data

May 16, 1977 [SE] Sweden 1116/77

[51] Int. Cl. D19-04

[52] U.S. Cl. D19/27

[58] Field of Search D19/26-33;
281/4, 19 R, 21 R, 25 R, 29, 34, 35

[56] References Cited

U.S. PATENT DOCUMENTS

D. 87,734 9/1932 Vredenburgh D19/26
D. 184,004 12/1958 Chase D19/27

2,687,901 8/1954 Wisner D19/27

OTHER PUBLICATIONS

V. P. D. Flyer #866-25m, 1968, p. 1.

Primary Examiner—Joel Stearman
Assistant Examiner—George P. Word

[57] CLAIM

The ornamental design for a binder, substantially as shown and described.

DESCRIPTION

FIG. 1 is a front perspective view of a binder showing my new design;

FIG. 2 is a rear perspective view thereof;

FIG. 3 is an enlarged scale fragmentary right side elevational view taken along line 3—3 of FIG. 1;

FIG. 4 is an enlarged scale fragmentary left side elevational view taken along line 4—4 of FIG. 1; and

FIG. 5 is an enlarged scale top plan view of the binder in a partially closed condition, the bottom plan view being a mirror image thereof.

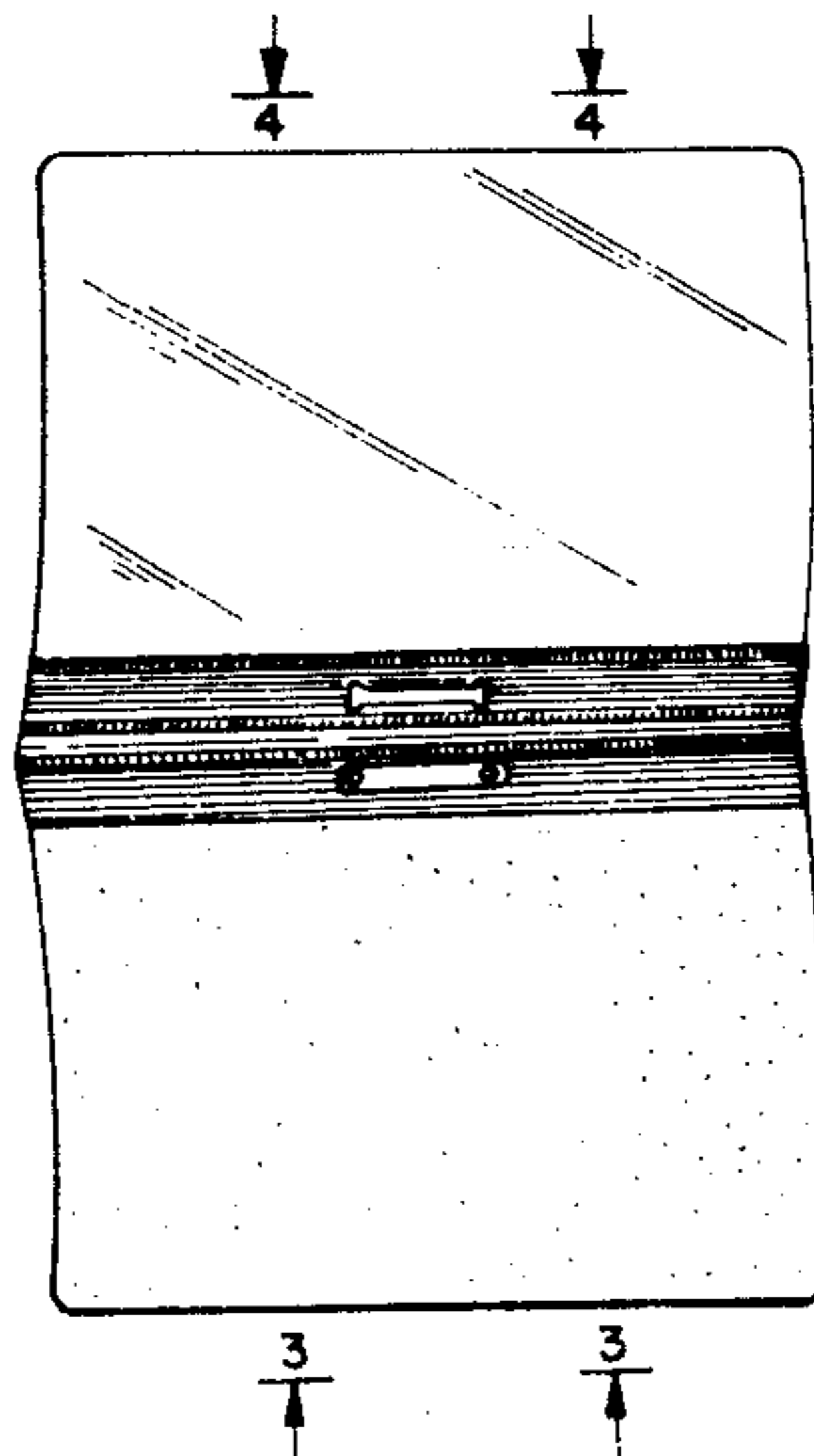
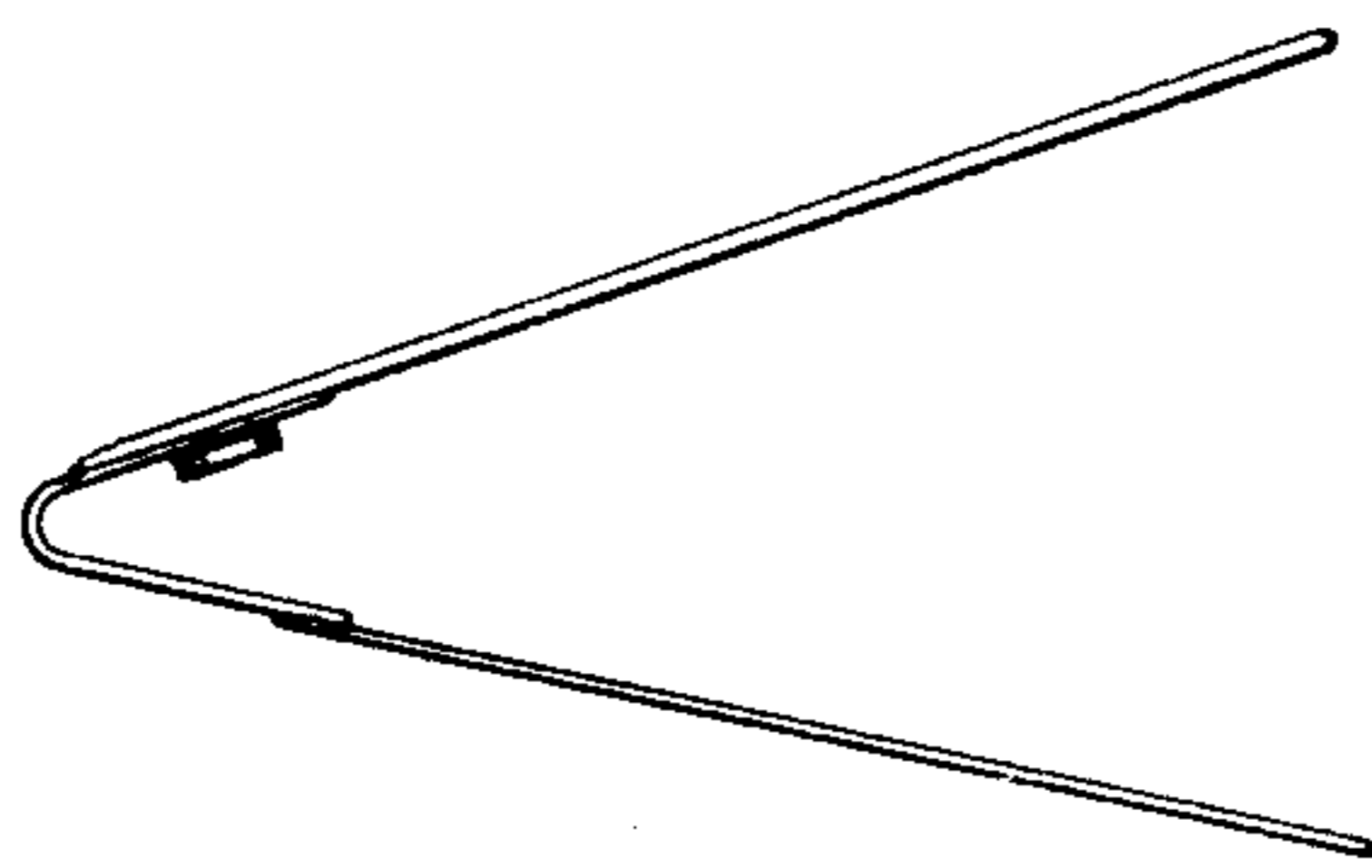

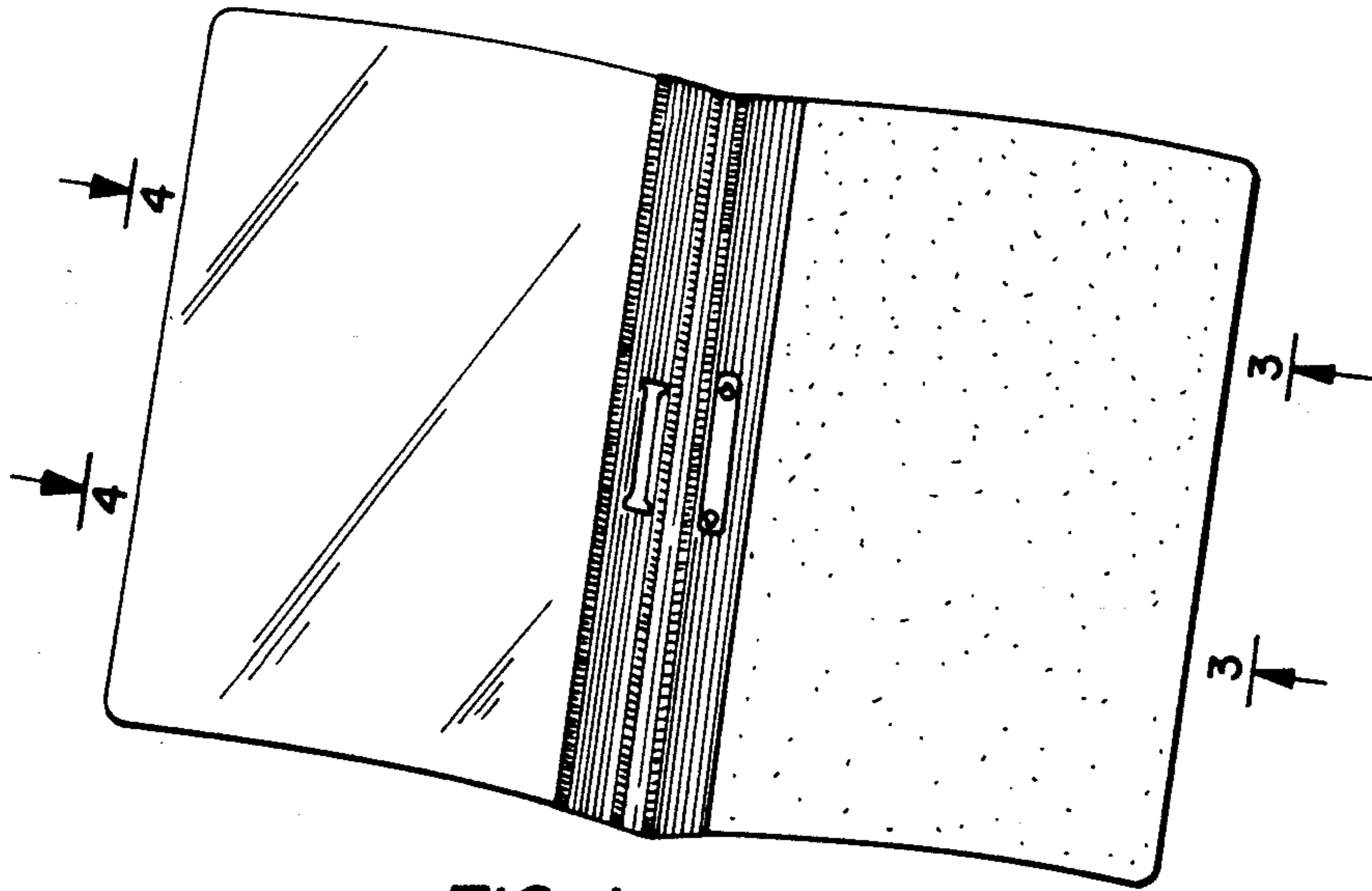

FIG. 1

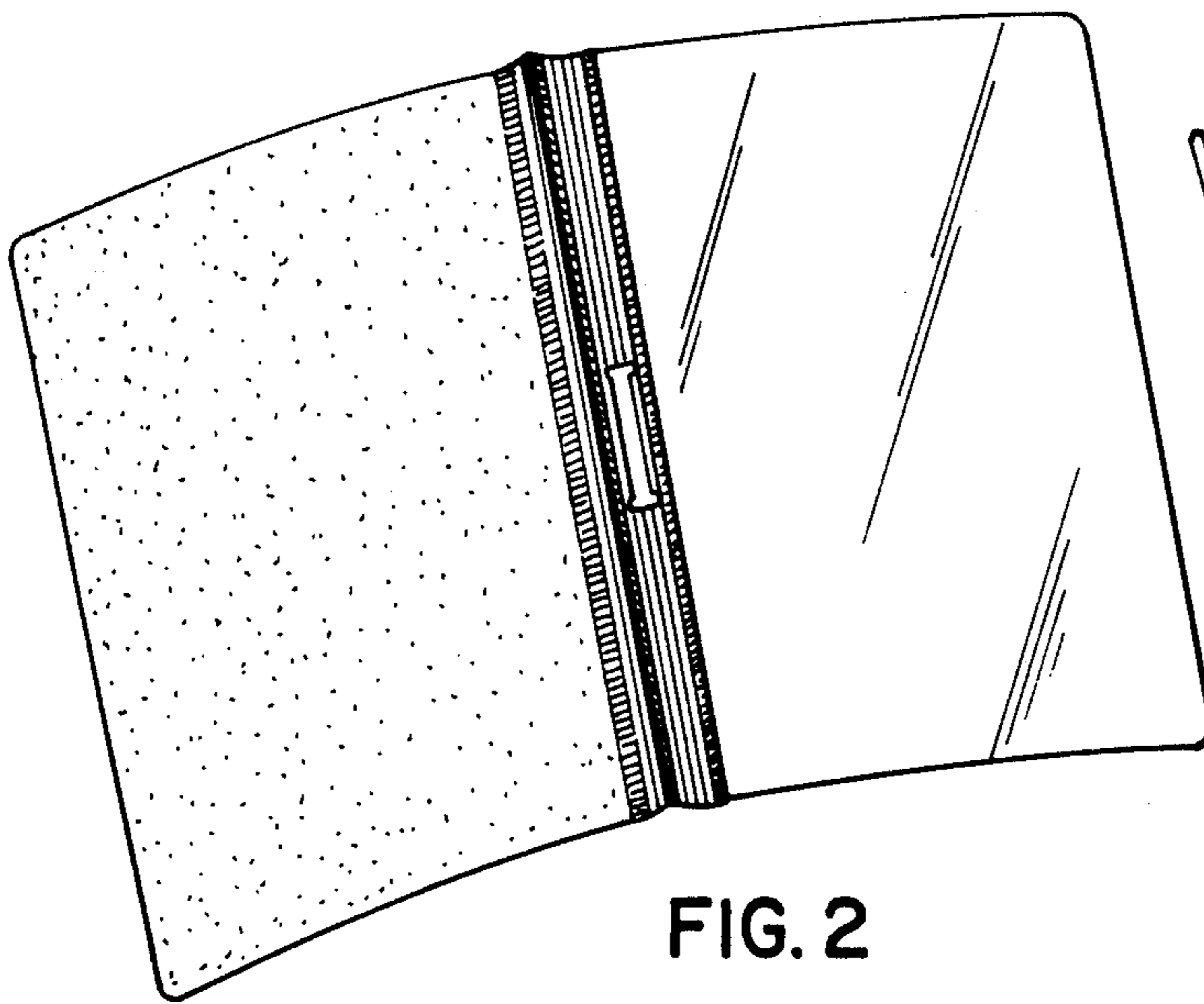

FIG. 2

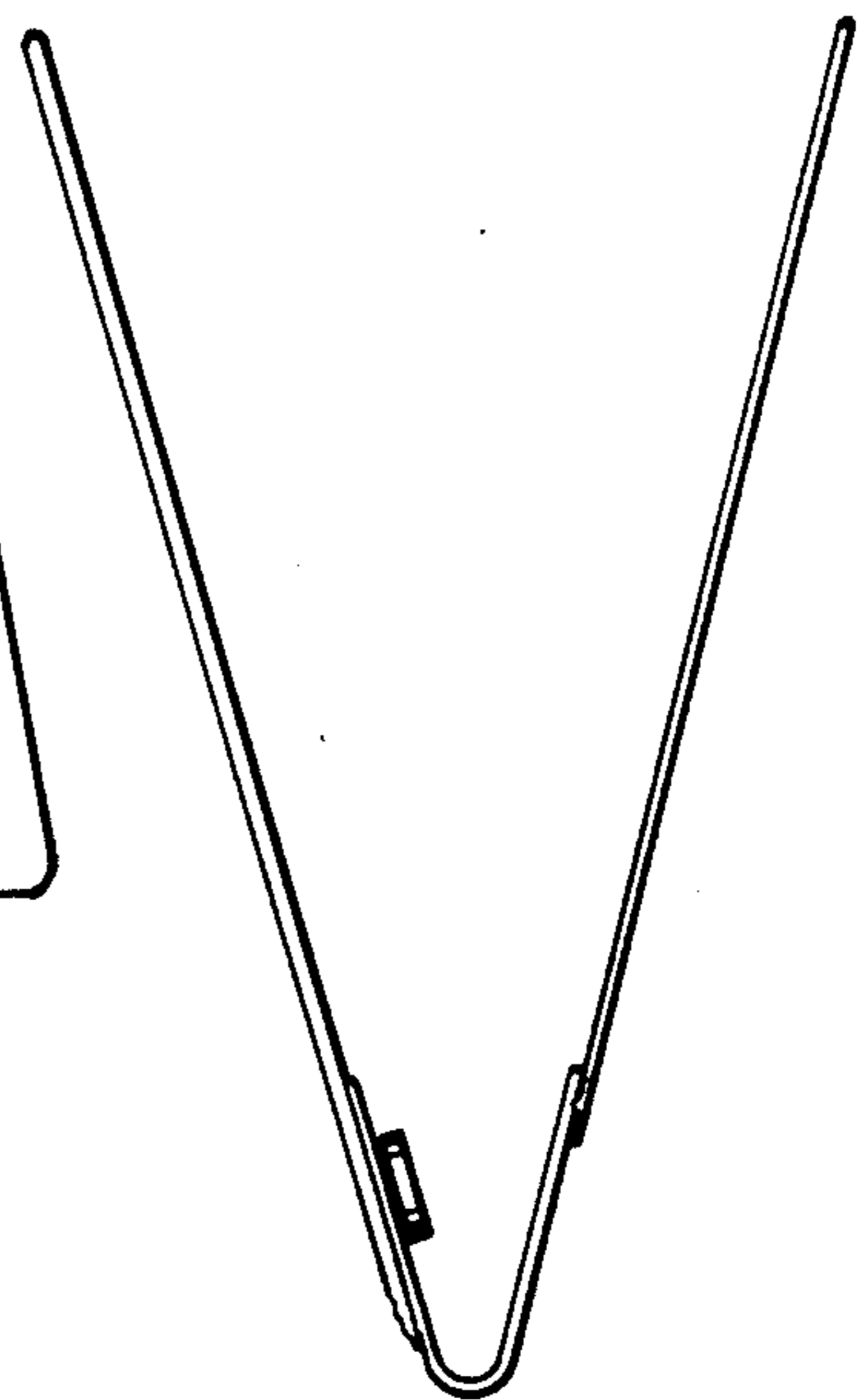

FIG. 5

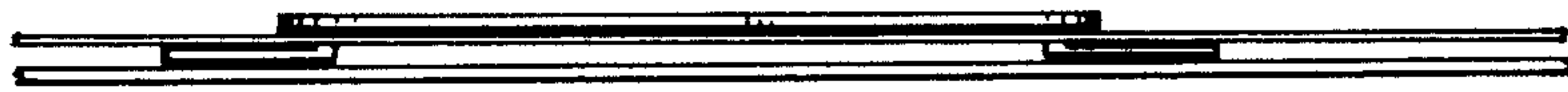

FIG. 3

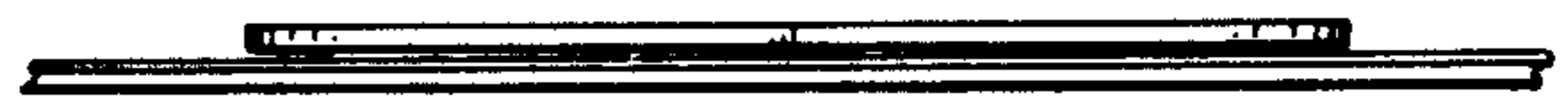

FIG. 4