

- [54] **PREPARATION BOWL**
- [75] Inventor: **Arne P. Darnell, Karlshamn, Sweden**
- [73] Assignee: **Perstorp AB, Perstorp, Sweden**
- [**] Term: **14 Years**
- [21] Appl. No.: **904,250**
- [22] Filed: **May 9, 1978**
- [30] **Foreign Application Priority Data**
 Nov. 24, 1977 [SE] Sweden 772428
- [51] Int. Cl. **D07-01**
- [52] U.S. Cl. **D7/64; D7/67**
- [58] Field of Search **D7/59, 60, 64, 65, 67, D7/39, 50**

[56] **References Cited**
U.S. PATENT DOCUMENTS

- D. 163,849 7/1951 Burroughs D7/64
- D. 167,166 7/1952 Rodier D7/64

- D. 236,409 8/1975 Cyren D7/64
- 2,750,769 6/1956 Yost et al. D7/39 X

OTHER PUBLICATIONS

Tableware, Feb., 1964, p. 160, item #29 at top left, Handle of Creamer in top panel.

Primary Examiner—Winifred E. Herrmann
Attorney, Agent, or Firm—Stevens, Davis, Miller & Mosher

[57] **CLAIM**

The ornamental design for a preparation bowl, as shown.

DESCRIPTION

FIG. 1 is a front elevational view of my design for a preparation bowl;
FIG. 2 is a right side elevational view thereof;
FIG. 3 is a left side elevational view thereof;
FIG. 4 is a top plan view thereof; and
FIG. 5 is a bottom plan view thereof.

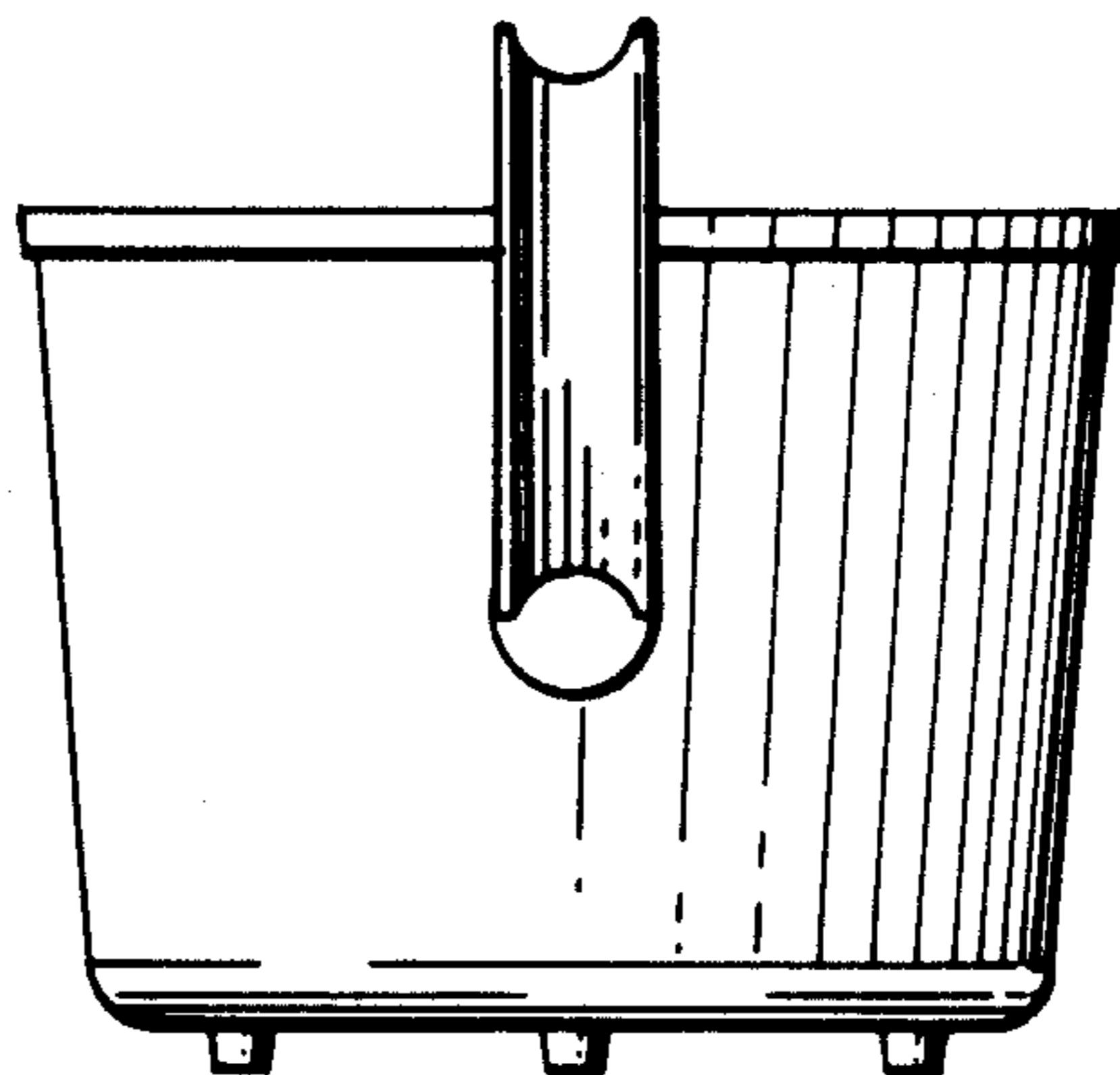
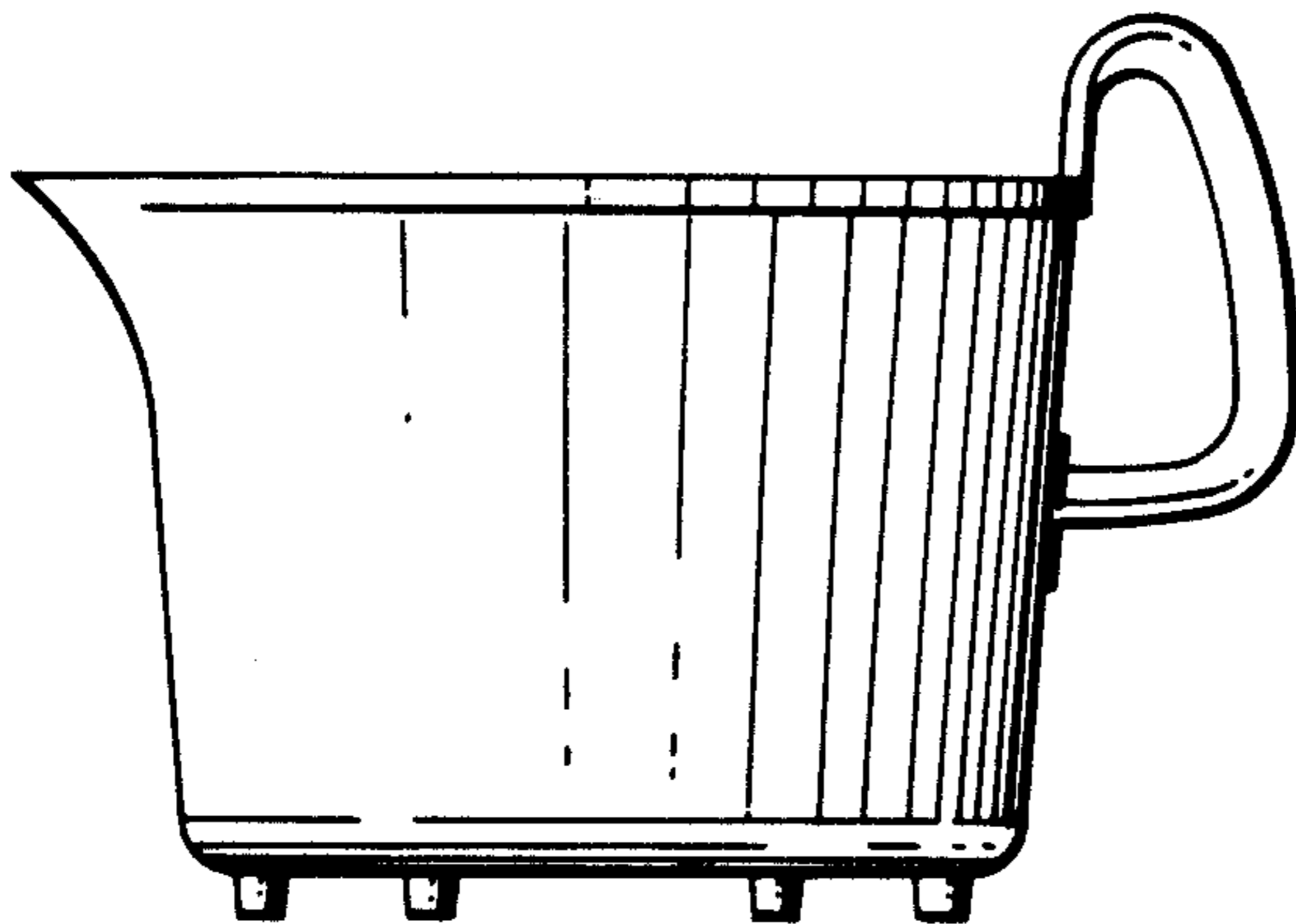

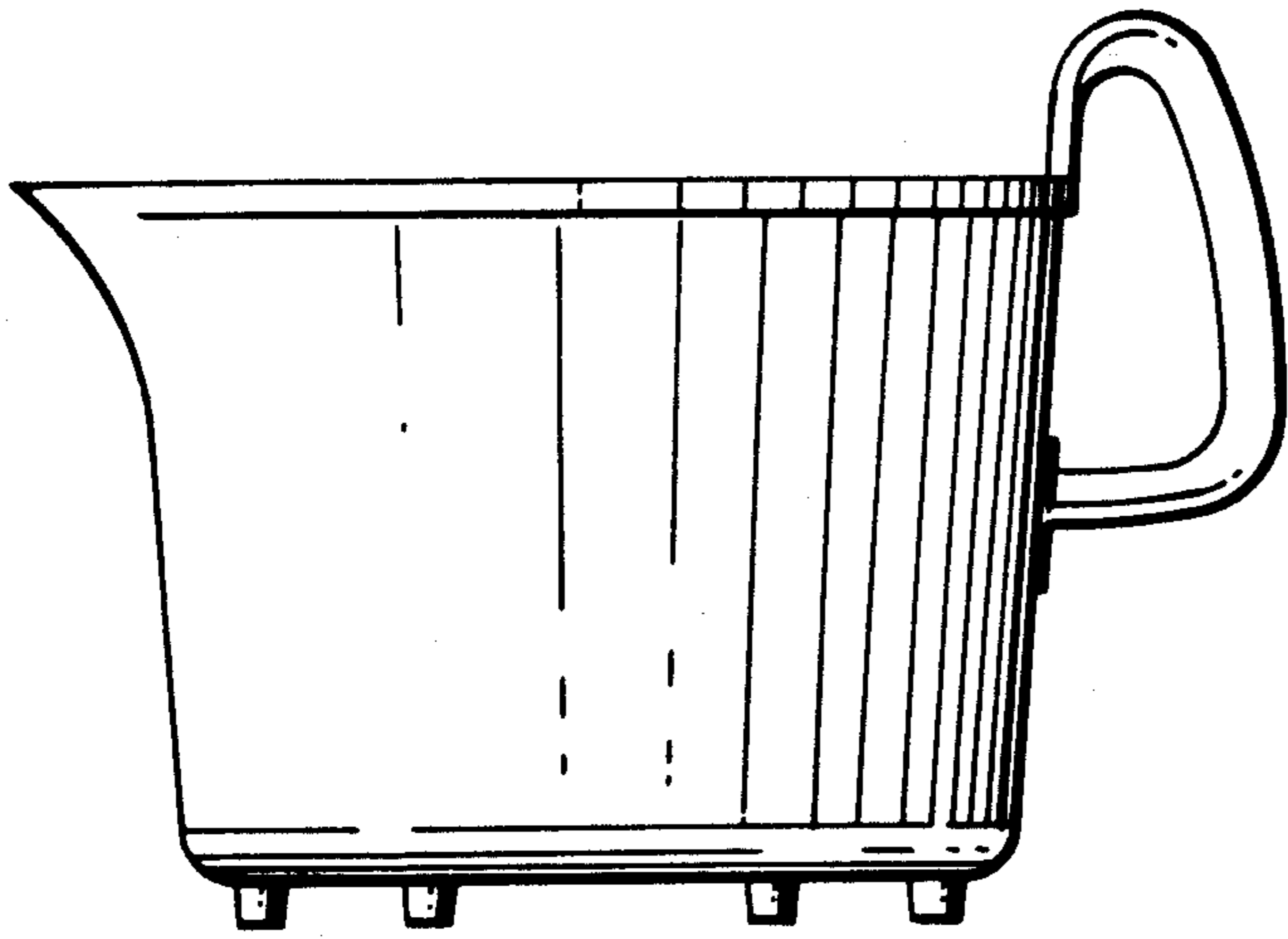

FIG. 1

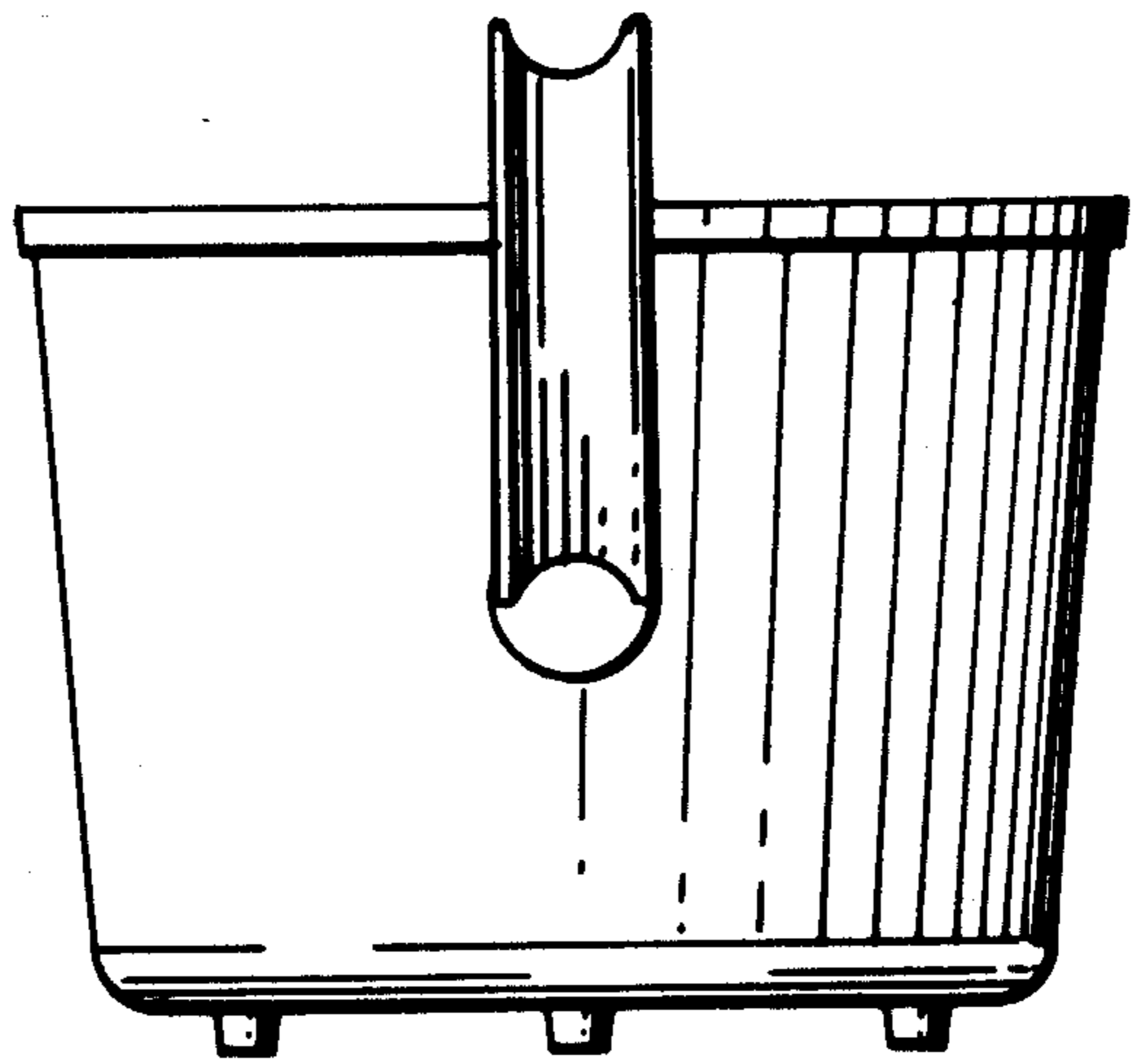

FIG. 2

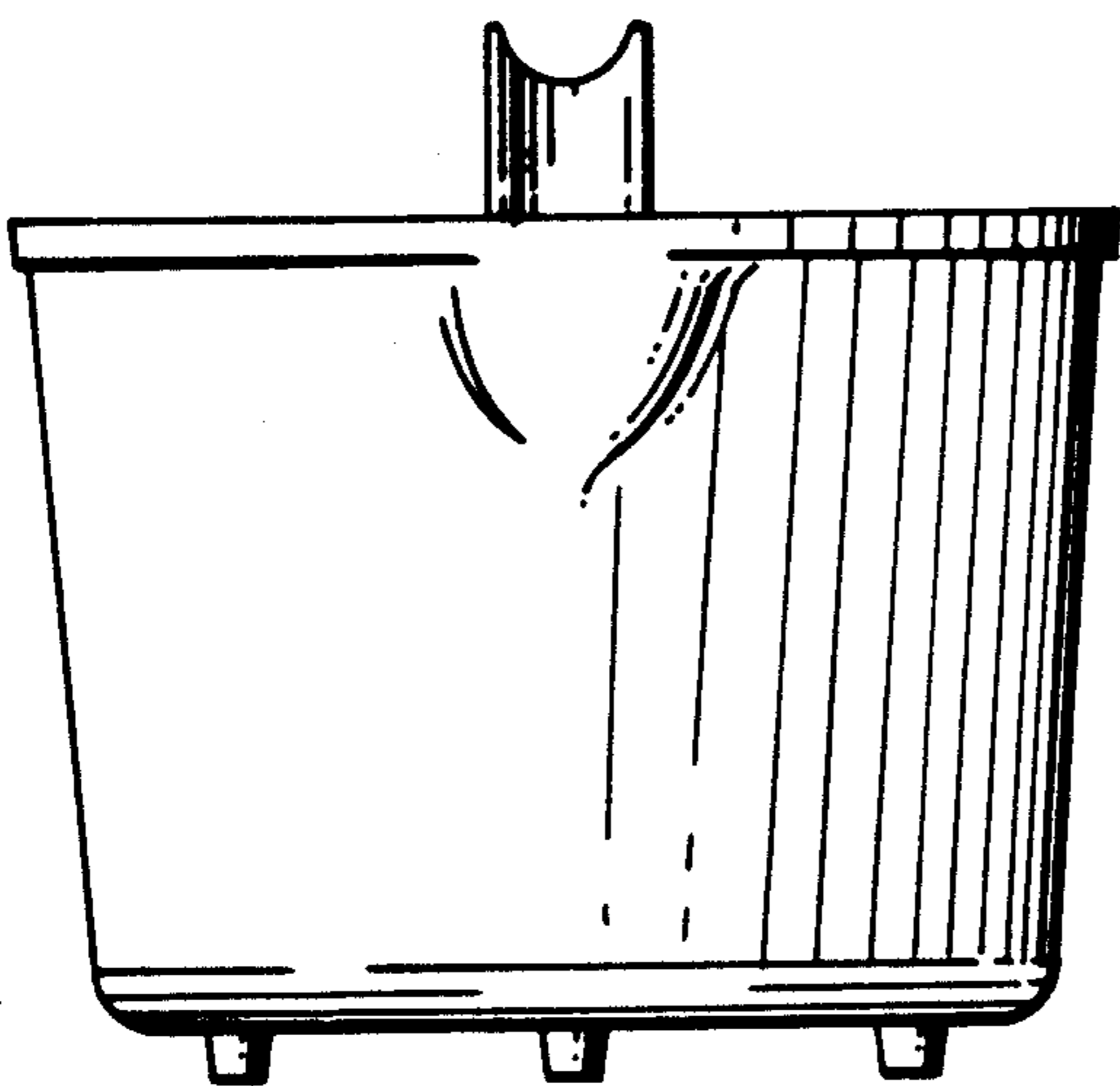

FIG. 3

FIG. 4

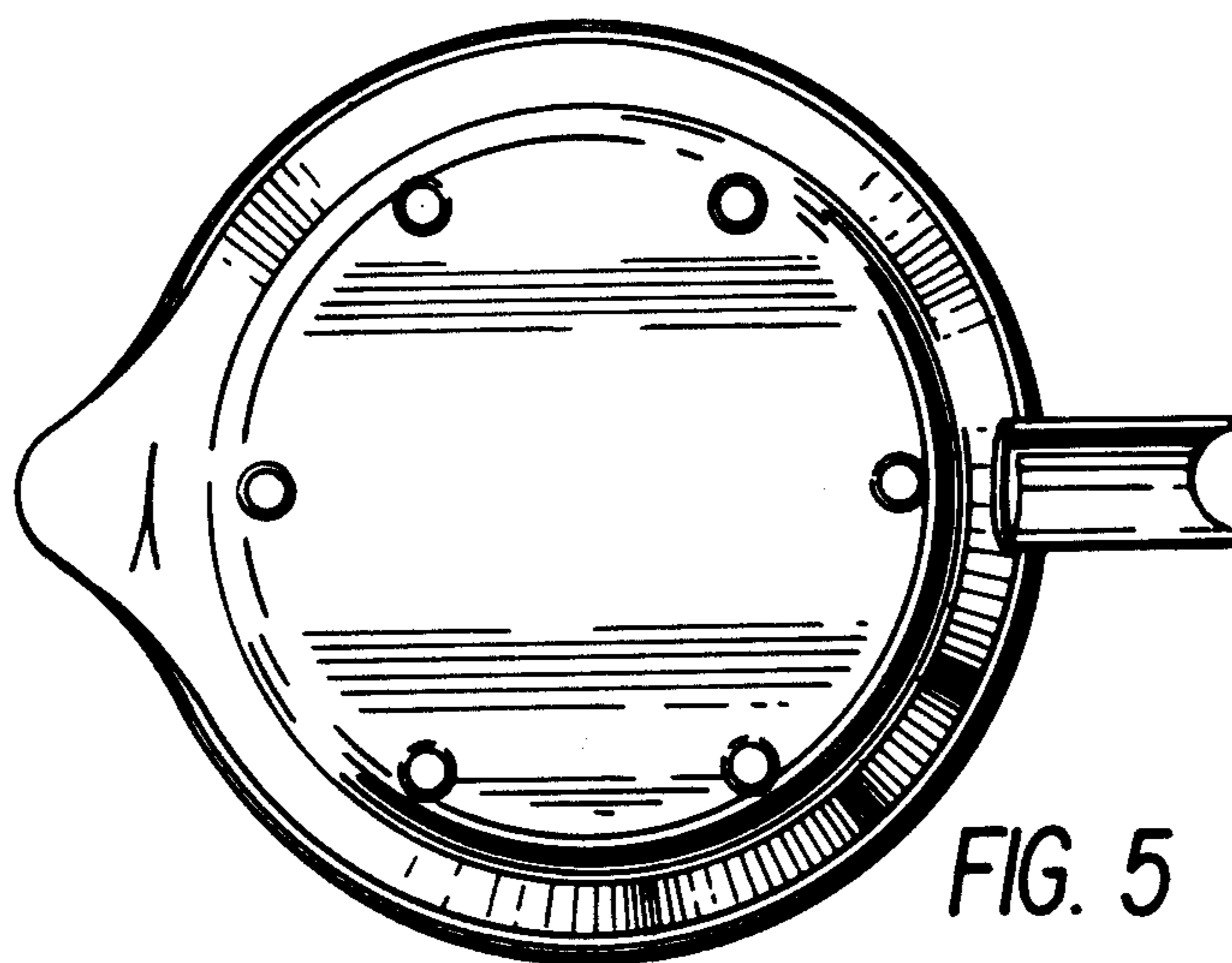
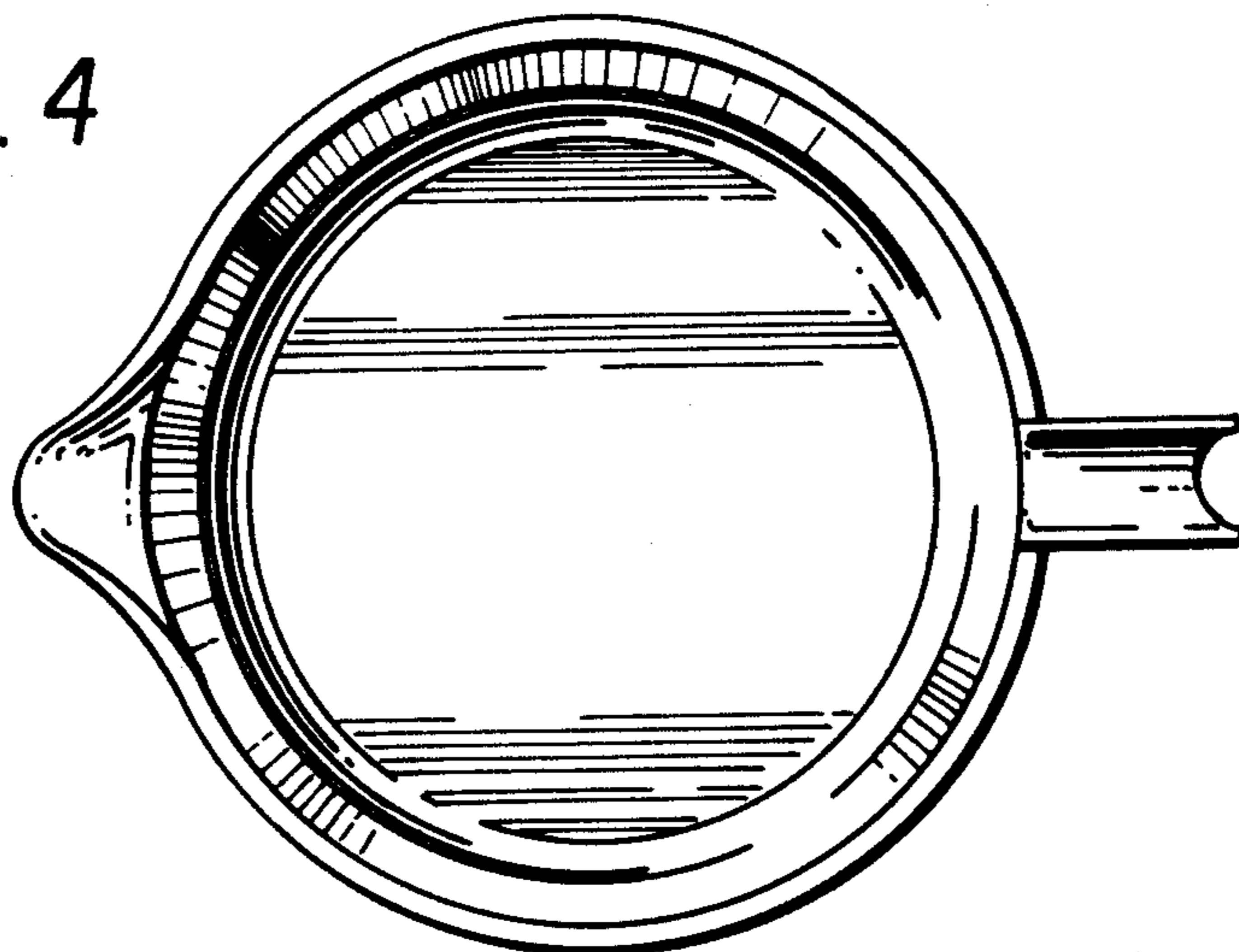

FIG. 5