

[54] TOY CIRCUS TRAIN

[75] Inventor: **Ralph M. Nowak**, Marblehead, Mass.

[73] Assignee: **CPG Products Corp.**, Minneapolis, Minn.

[**] Term: **14 Years**

[21] Appl. No.: **871,417**

[22] Filed: **Jan. 23, 1978**

[51] Int. Cl. **D21-01**

[52] U.S. Cl. **D21/129; D21/149**

[58] Field of Search **46/216, 217, 218; D21/129, 149**

[56] **References Cited**

U.S. PATENT DOCUMENTS

D. 236,523 8/1975 Reiling D21/129

OTHER PUBLICATIONS

Muller Wooden Toy 1973 Catalog, American Craftsman Series, p. 4, Item #402, Toy Train.

J. C. Penney Xmas Catalog, 1975, p. 336, Circus Train at bottom of page.

J. C. Penney Xmas Catalog, 1975, p. 351, Nerf Animals at top of page.

Primary Examiner—Joel Stearman

Assistant Examiner—Charles A. Rademaker

Attorney, Agent, or Firm—Gene O. Enockson; L. Meroy Lillehaugen; Paul W. Auffermann

[57] **CLAIM**

The ornamental design for a toy circus train, substantially as shown.

DESCRIPTION

FIG. 1 is a front perspective view of a toy circus train illustrating my new design;

FIG. 2 is a rear perspective view thereof;

FIG. 3 is a bottom plan view thereof;

FIG. 4 is a side elevational view thereof;

FIG. 5 is a bottom plan view thereof;

FIG. 6 is a rear elevational view thereof; and

FIG. 7 is a front elevational view thereof.

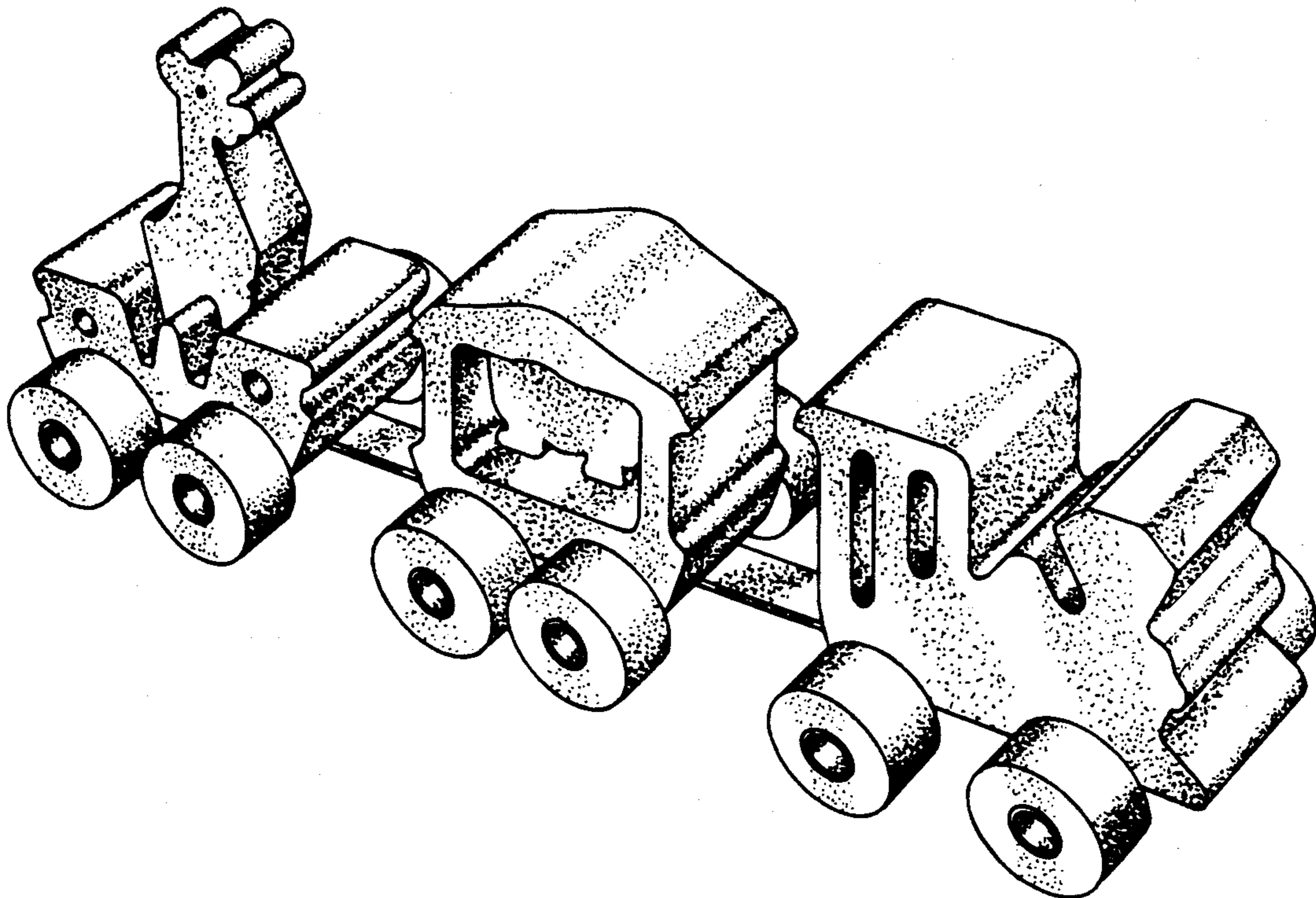

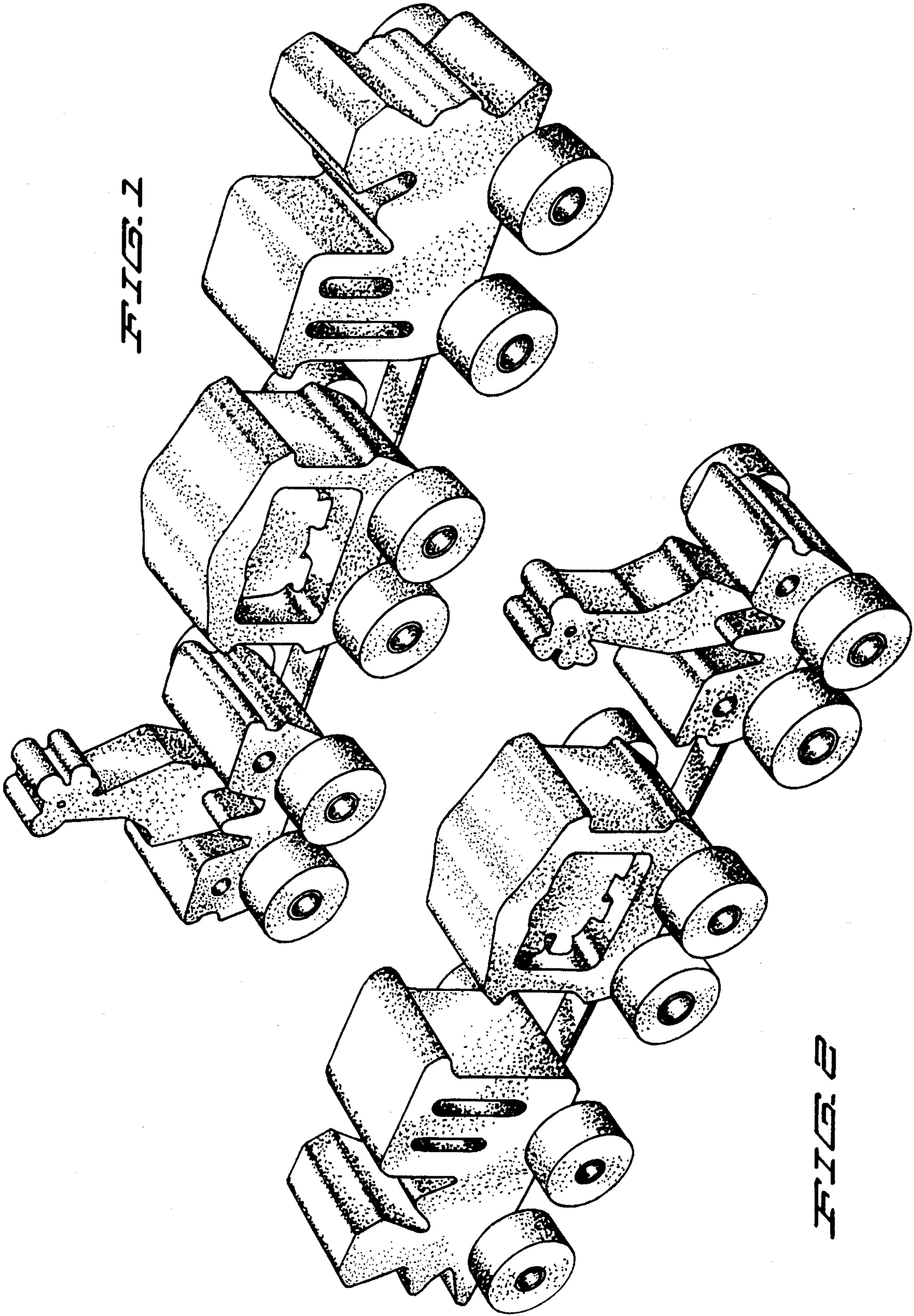

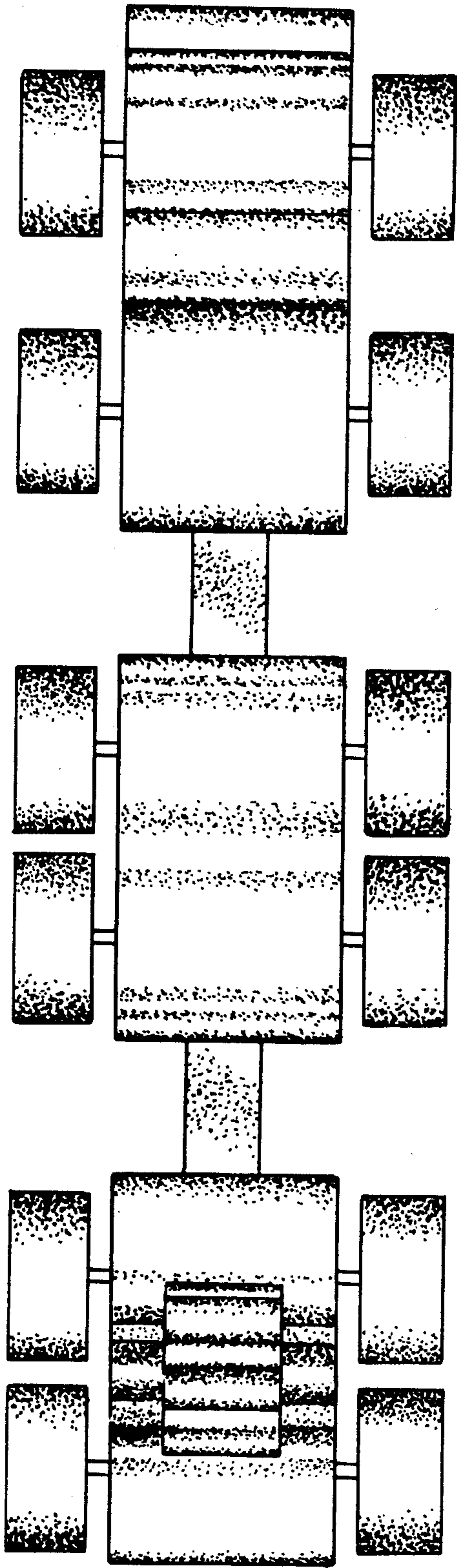

FIG. 3

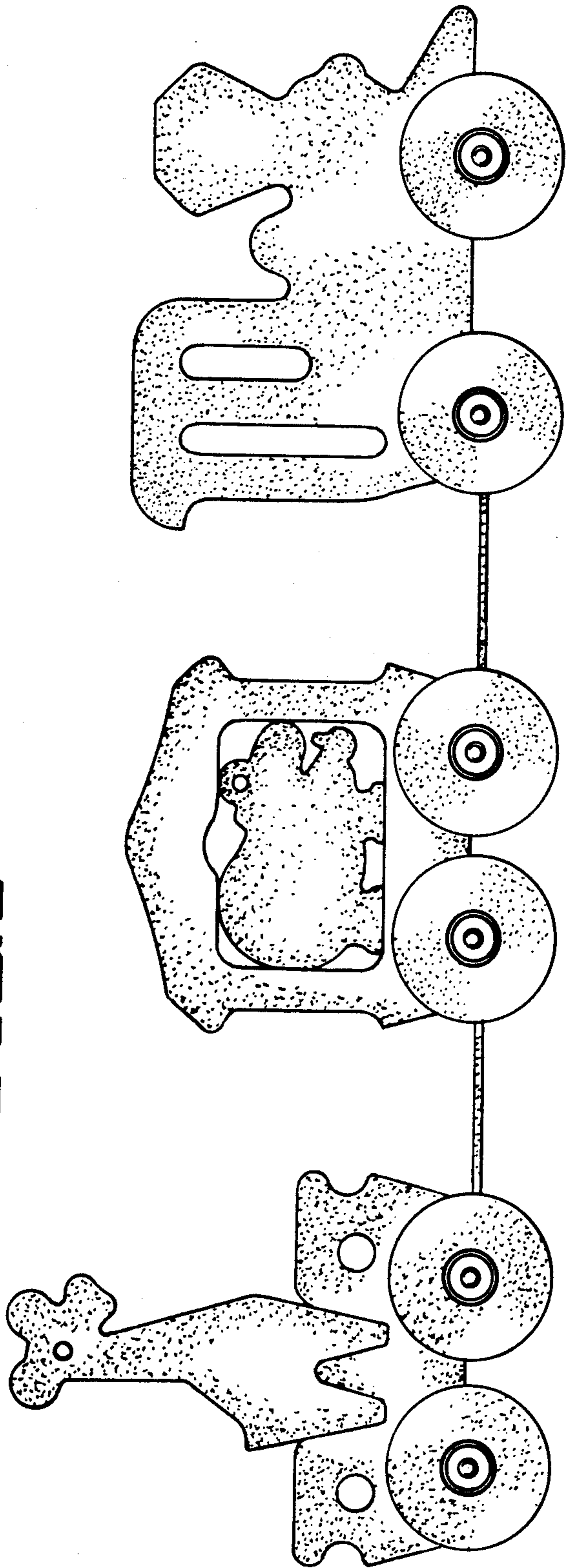

FIG. 4

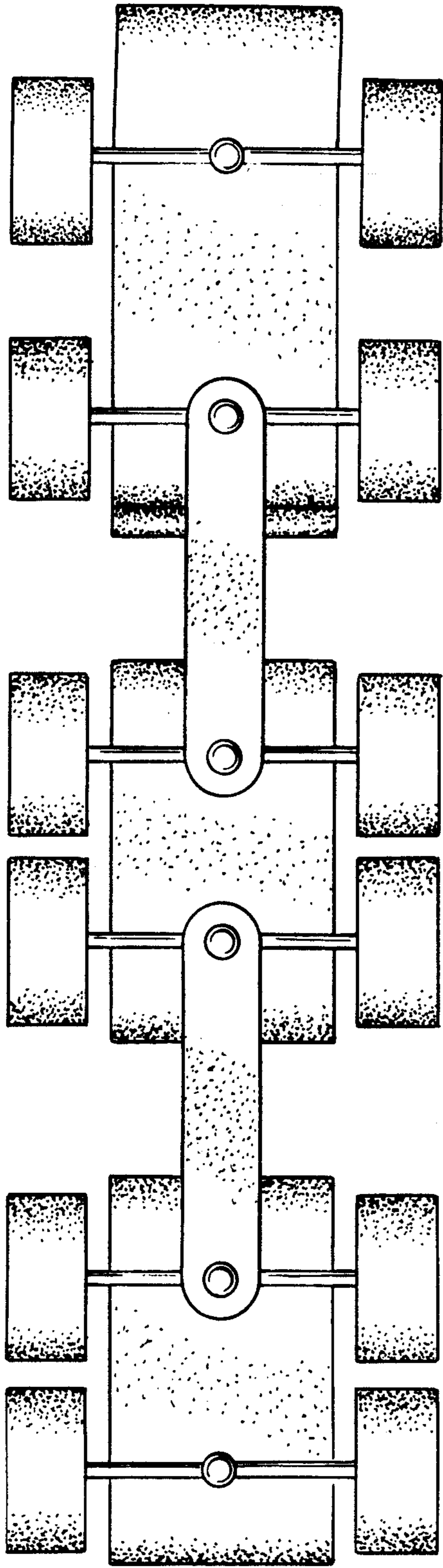

FIG. 5

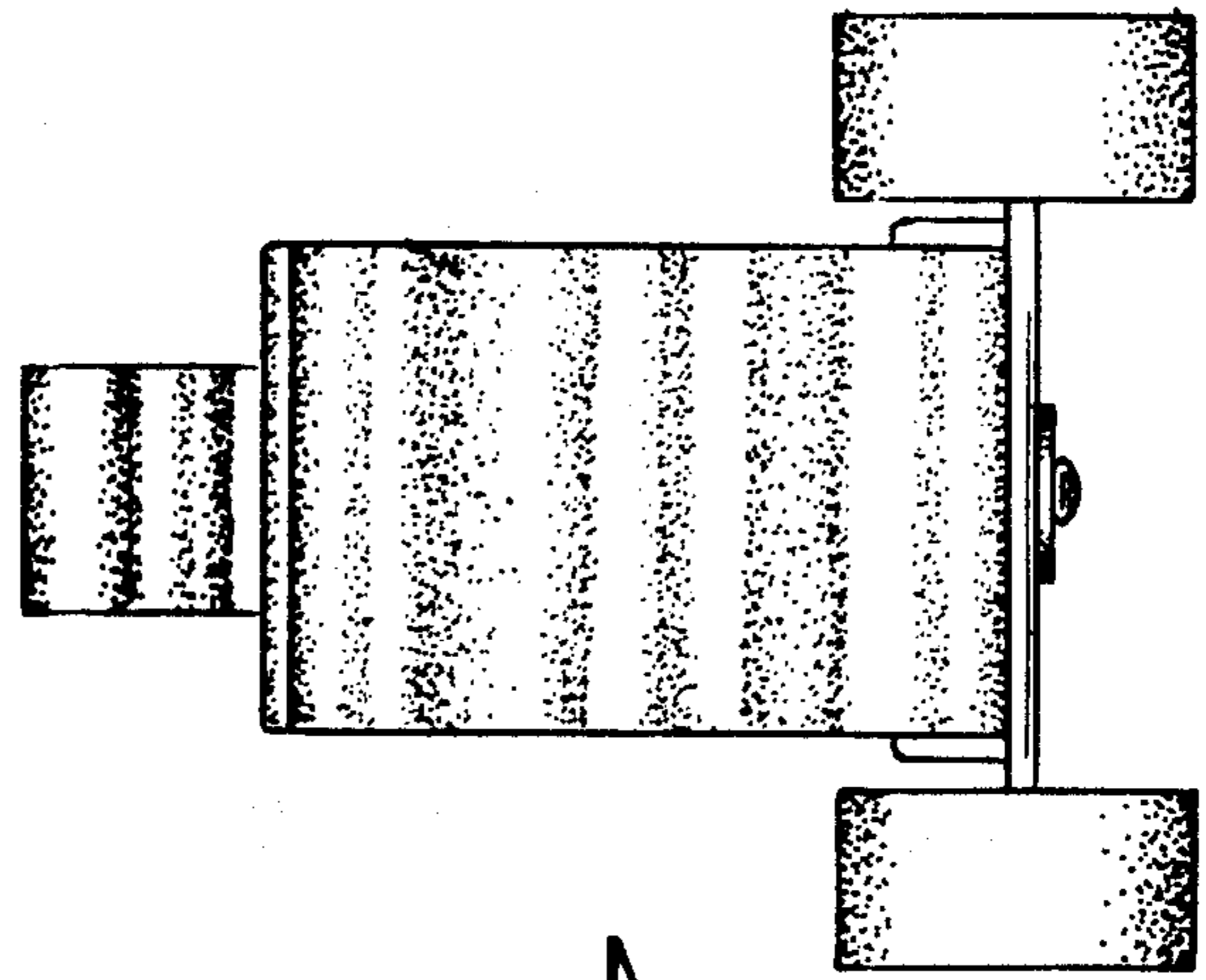

FIG. 7

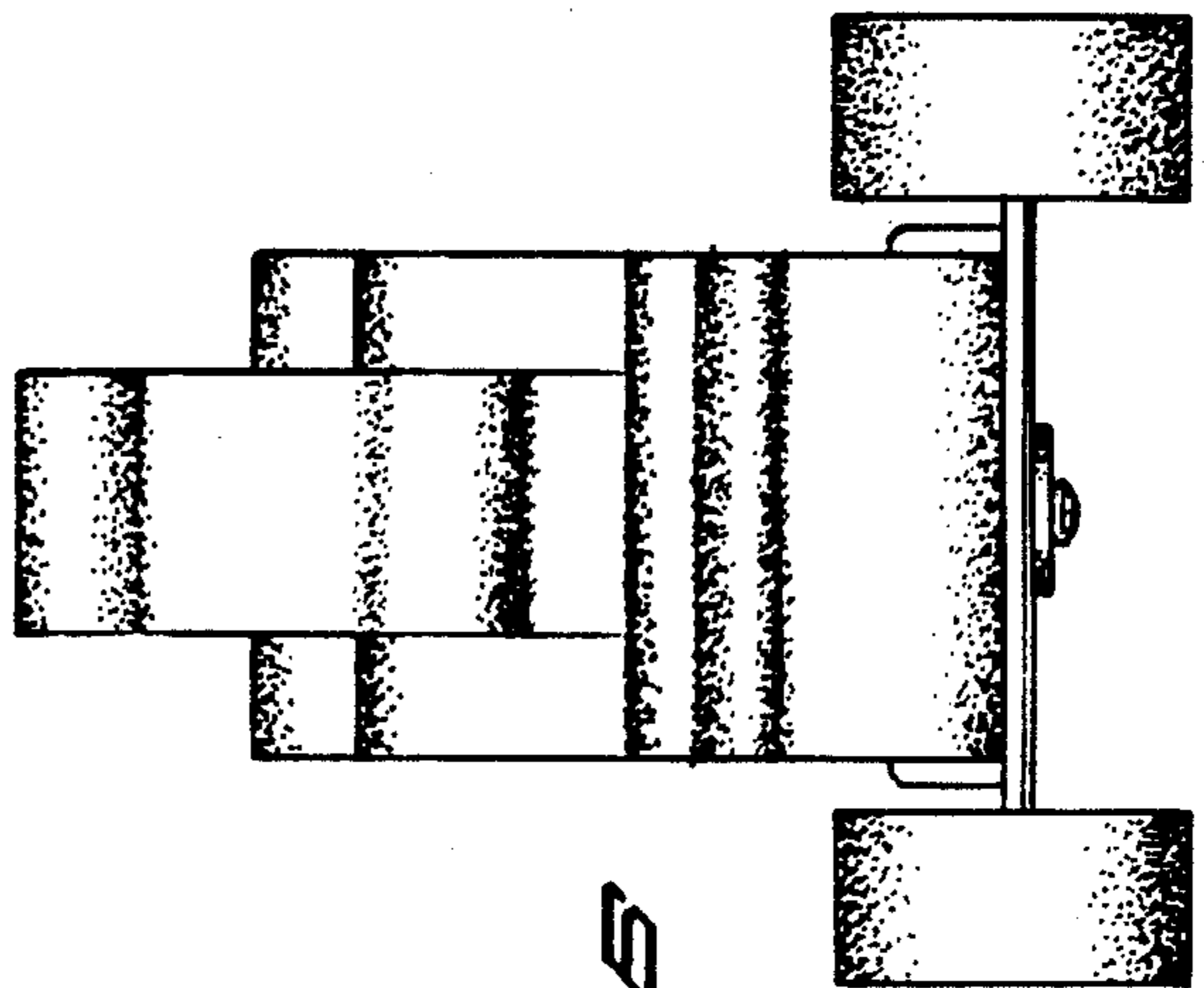

FIG. 6