

[54] FRUIT JUICER, OR SIMILAR ARTICLE

[75] Inventor: Nathan Fuchs, Brooklyn, N.Y.

[73] Assignee: Van Wyck International Corporation, New York, N.Y.

[\*\*] Term: 14 Years

[21] Appl. No.: 907,762

[22] Filed: May 19, 1978

[51] Int. Cl. .... D07-04

[52] U.S. Cl. .... D7/49

[58] Field of Search ..... D7/48, 49; 99/501, 502, 99/503, 504, 505, 506

References Cited

U.S. PATENT DOCUMENTS

|            |        |             |        |
|------------|--------|-------------|--------|
| D. 227,971 | 7/1973 | Weiss ..... | D7/48  |
| 1,894,858  | 1/1933 | Fromm ..... | 99/503 |
| 1,971,657  | 8/1934 | Quam .....  | 99/505 |

OTHER PUBLICATIONS

*Home Furnishings Daily*, Jul. 14, 1975, Section 2, p. 22, top left corner, Warning Products Juicer.

*Bloomington's Home/Living Cat.*, 4/1977, p. 20, Braun Citrus Juicer, bottom row.

*Industrial Design*, Jul.-Aug. 1973, p. 60, Aepi Juicer at bottom right and center.

Primary Examiner—Winifred E. Herrmann

Attorney, Agent, or Firm—McAulay, Fields, Fisher & Goldstein

[57] CLAIM

The ornamental design for a fruit juicer, or similar article, as shown.

DESCRIPTION

FIG. 1 is a perspective view of a fruit juicer, or similar article, as seen from above, showing new design; FIG. 2 is a similar view, as seen from below; FIG. 3 is a top plan view; FIG. 4 is a side elevational view; FIG. 5 is a front elevational view; FIG. 6 is a rear elevational view; and FIG. 7 is a bottom plan view.

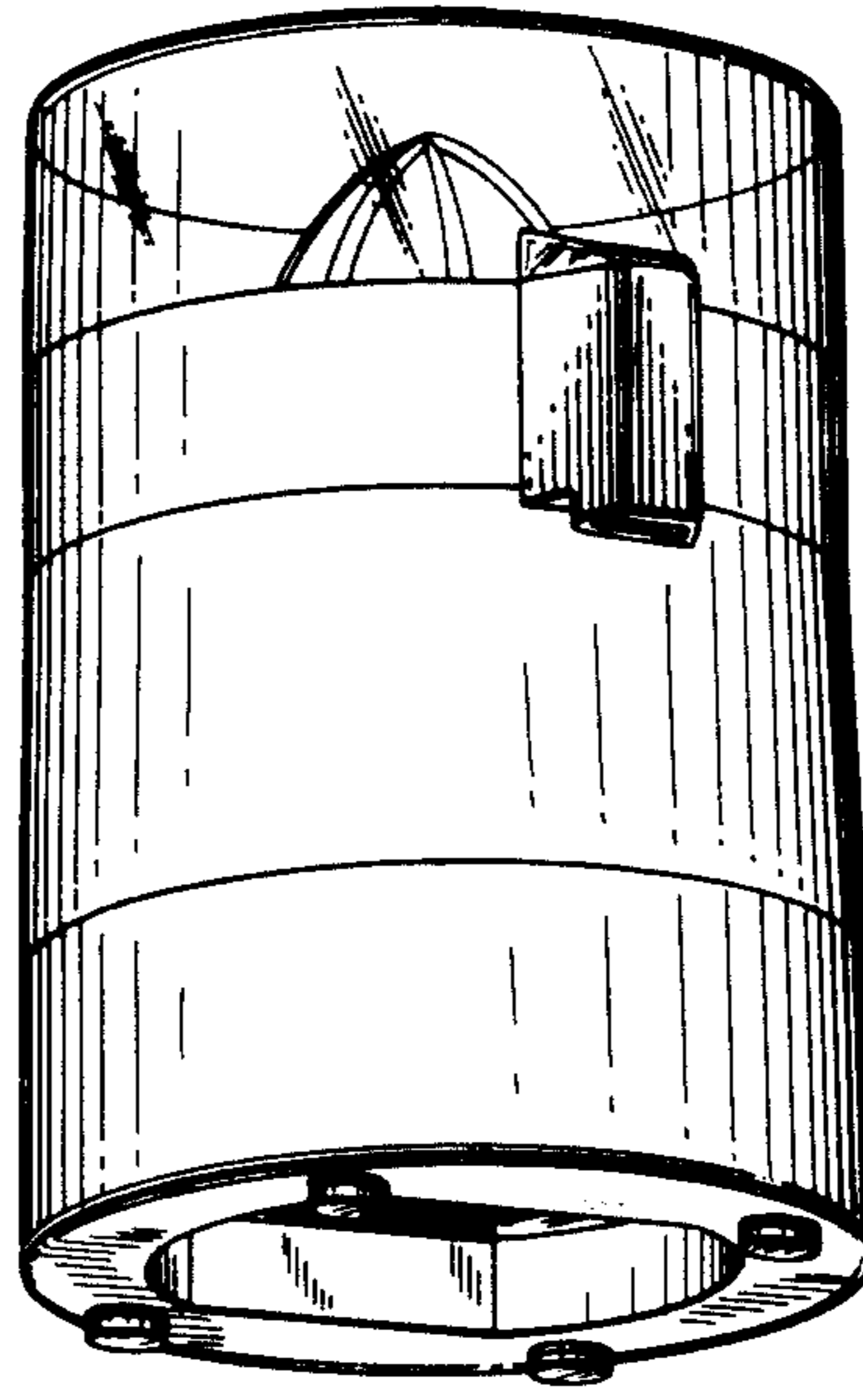
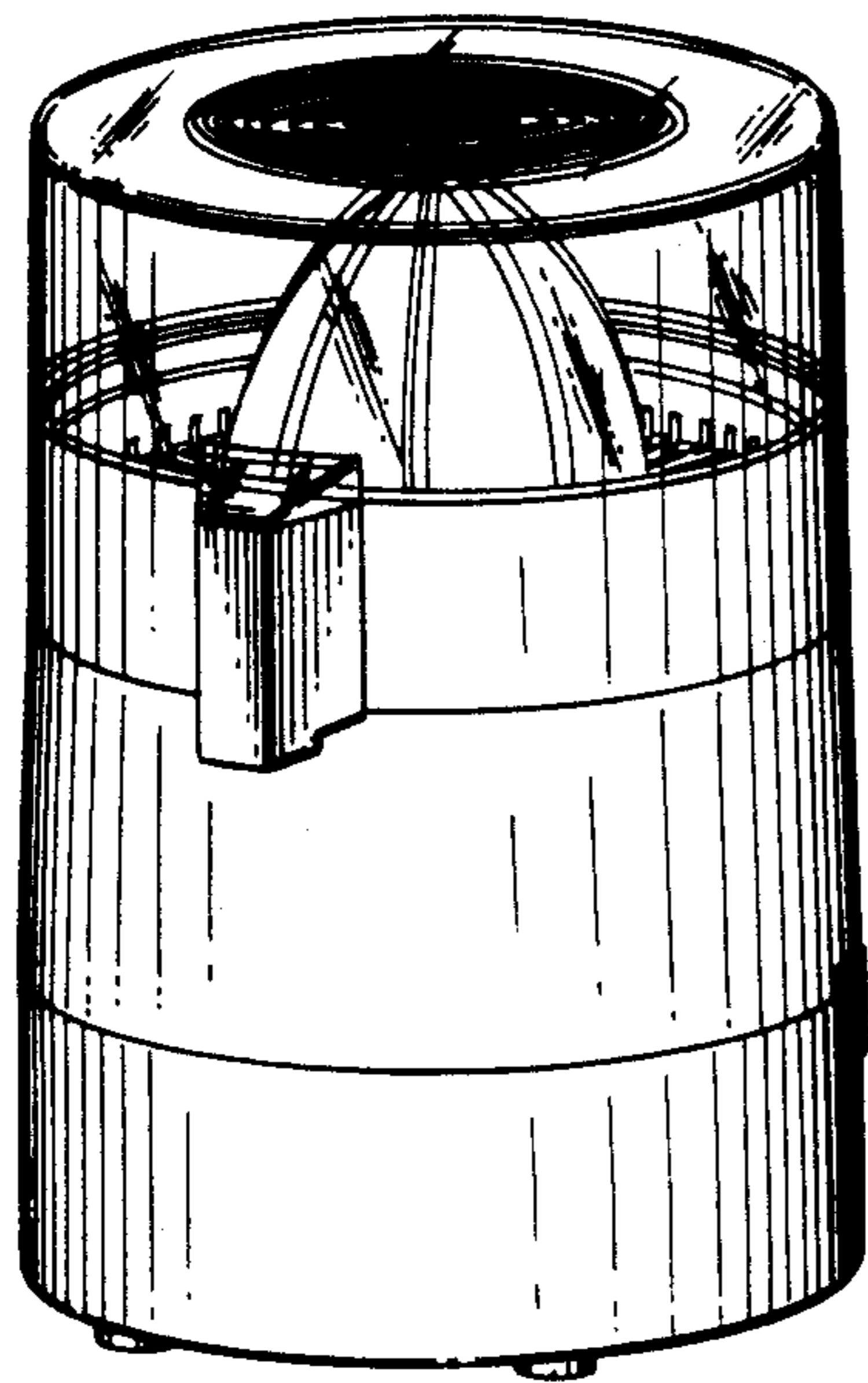

FIG. 2

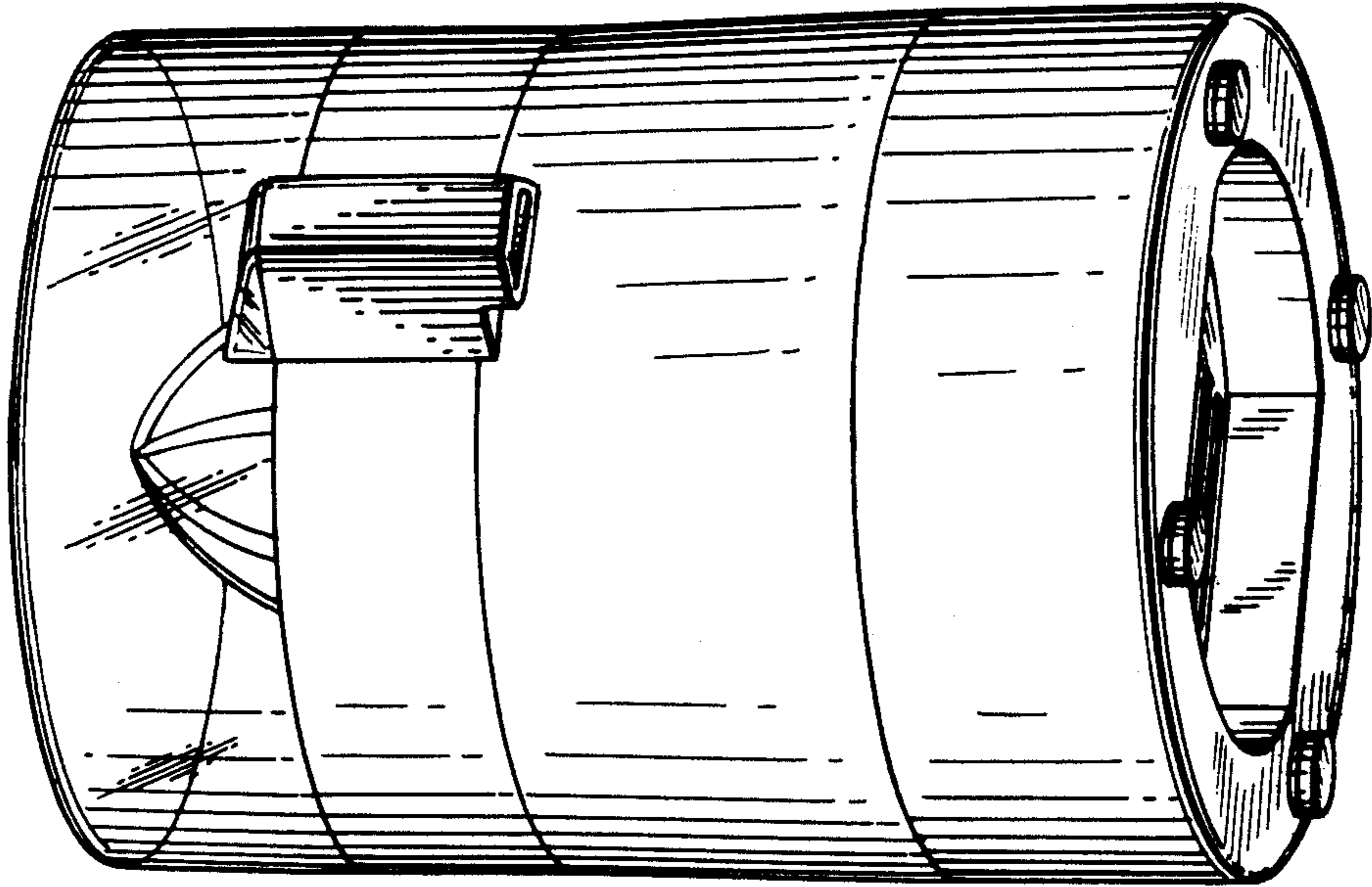
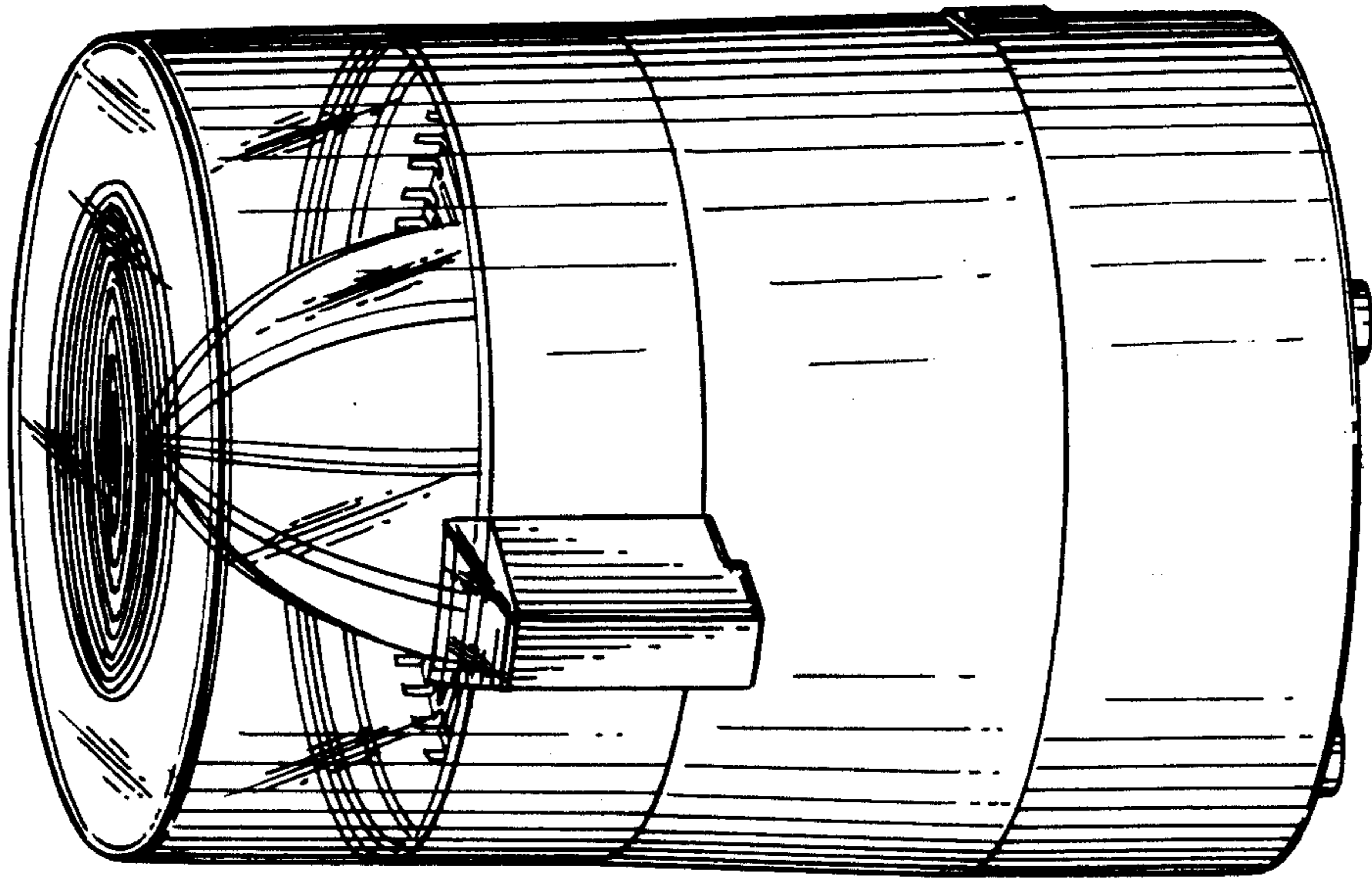
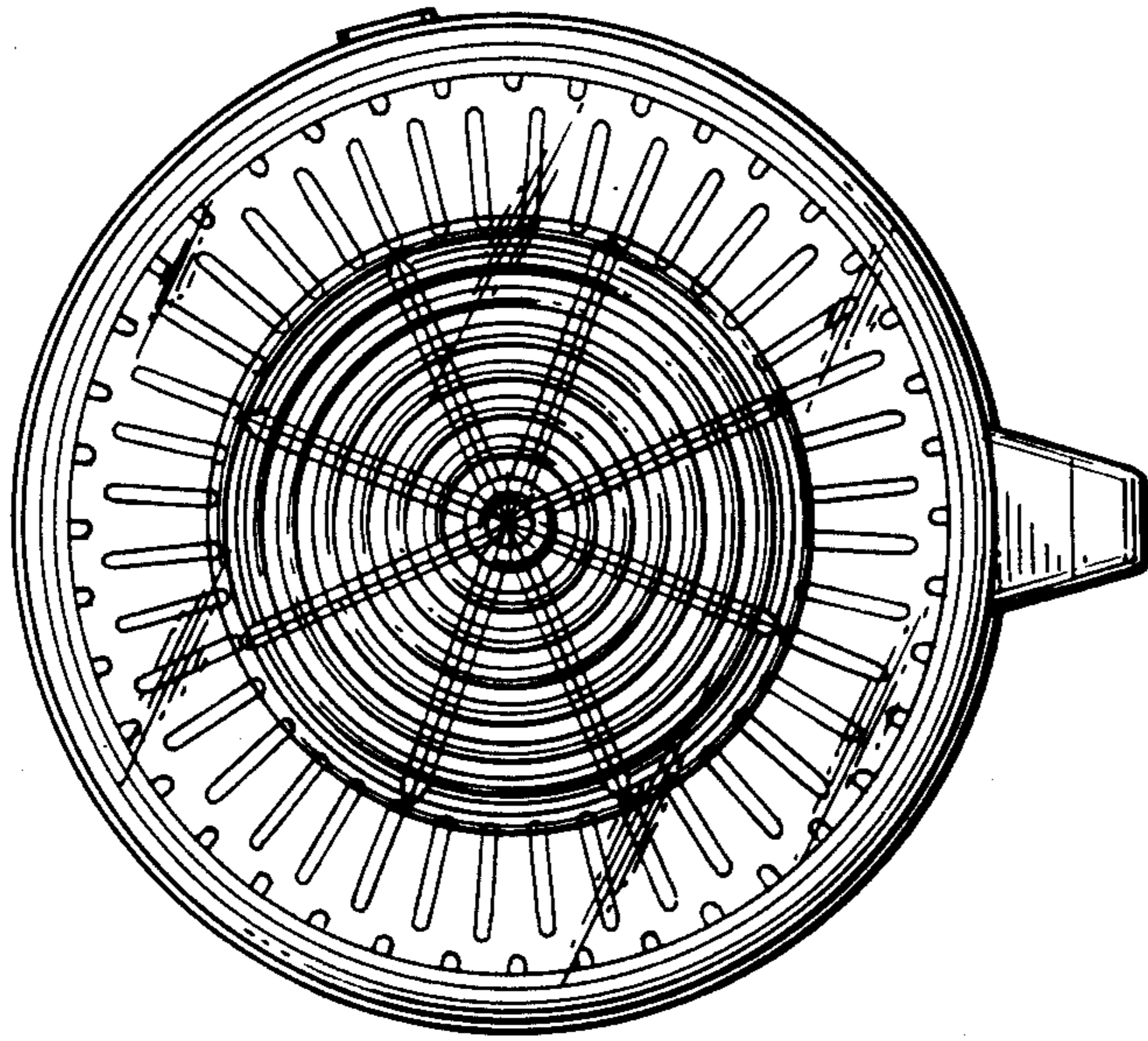
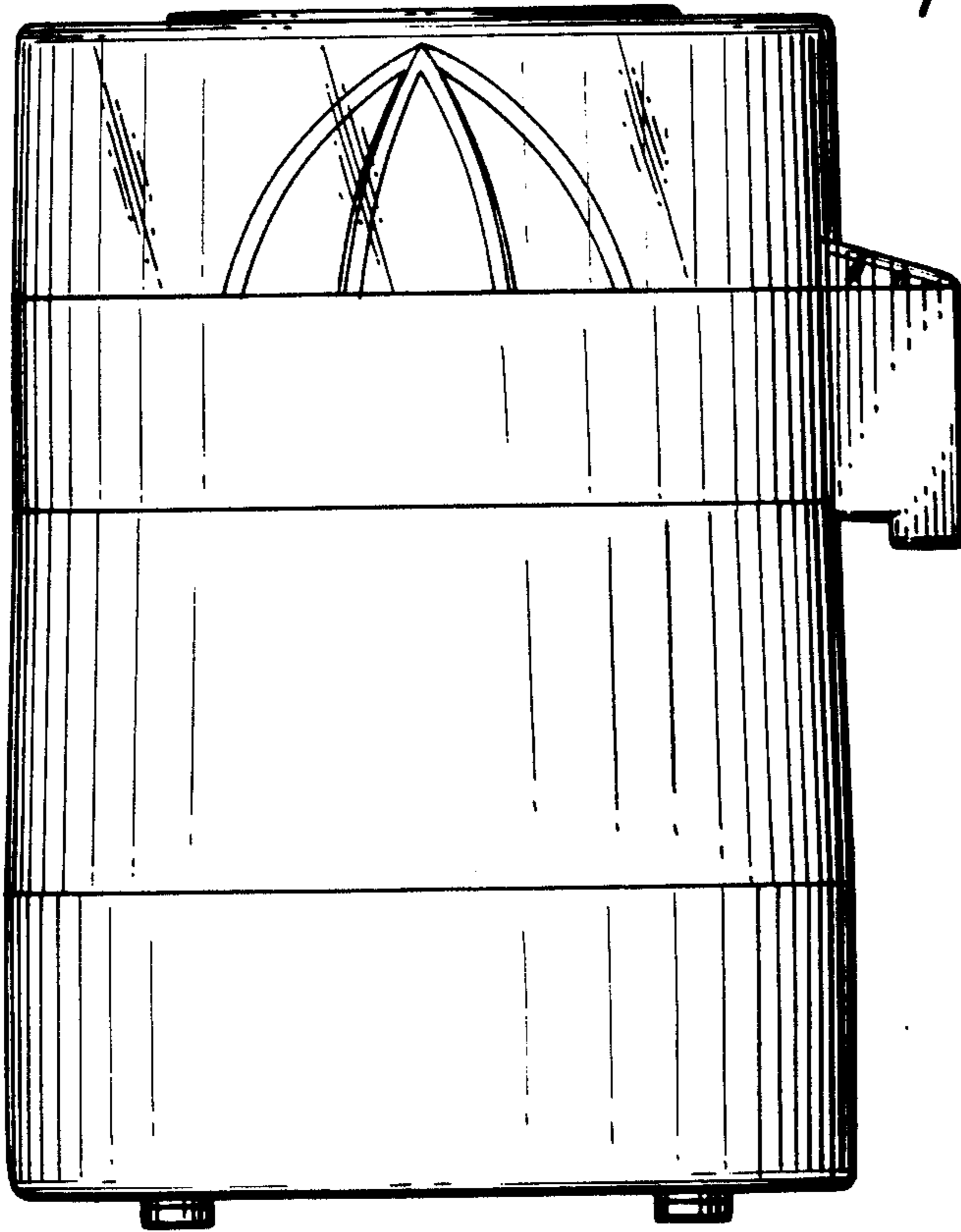

FIG. 1





*FIG. 3*



*FIG. 4*

FIG. 5

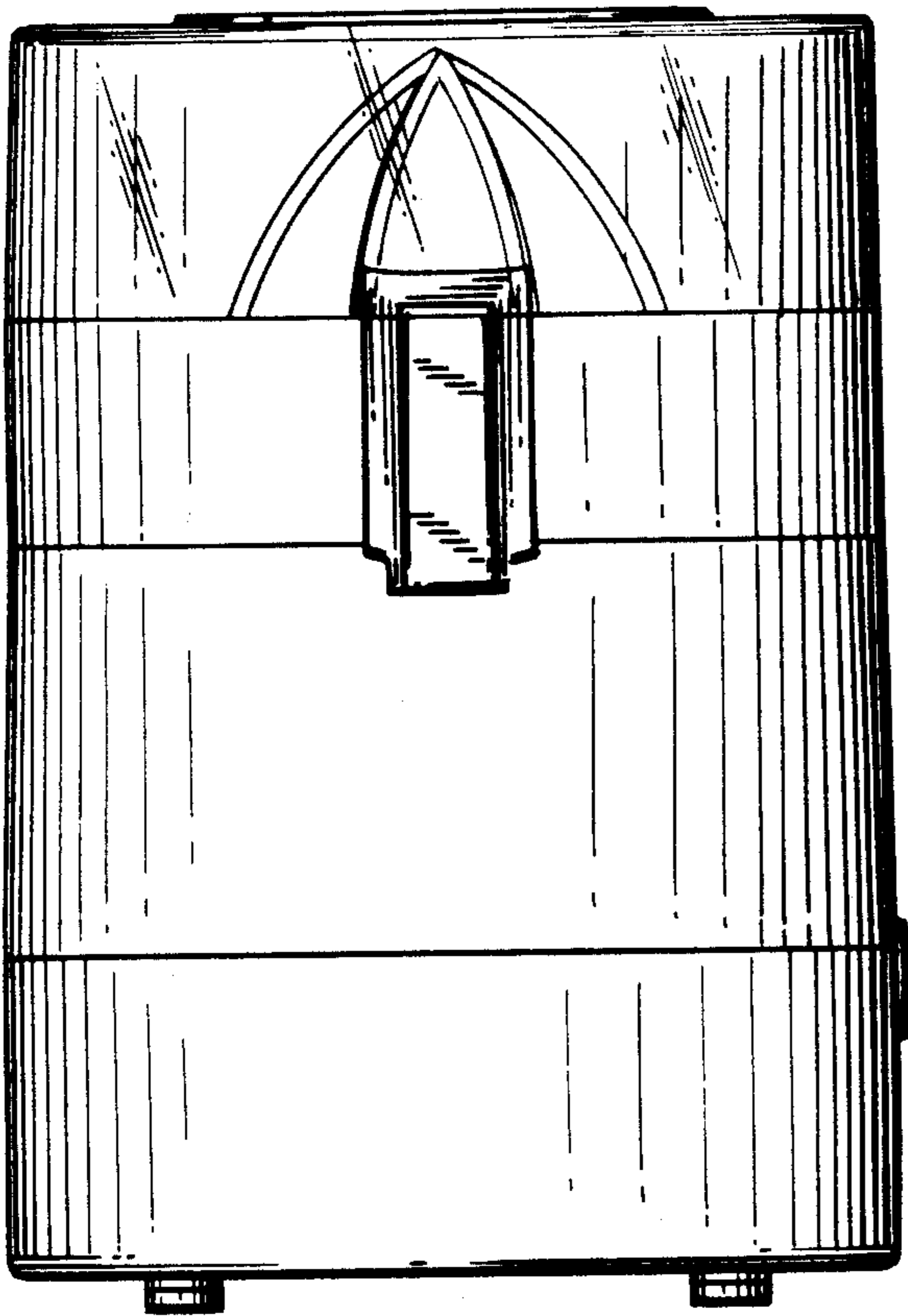

FIG. 6

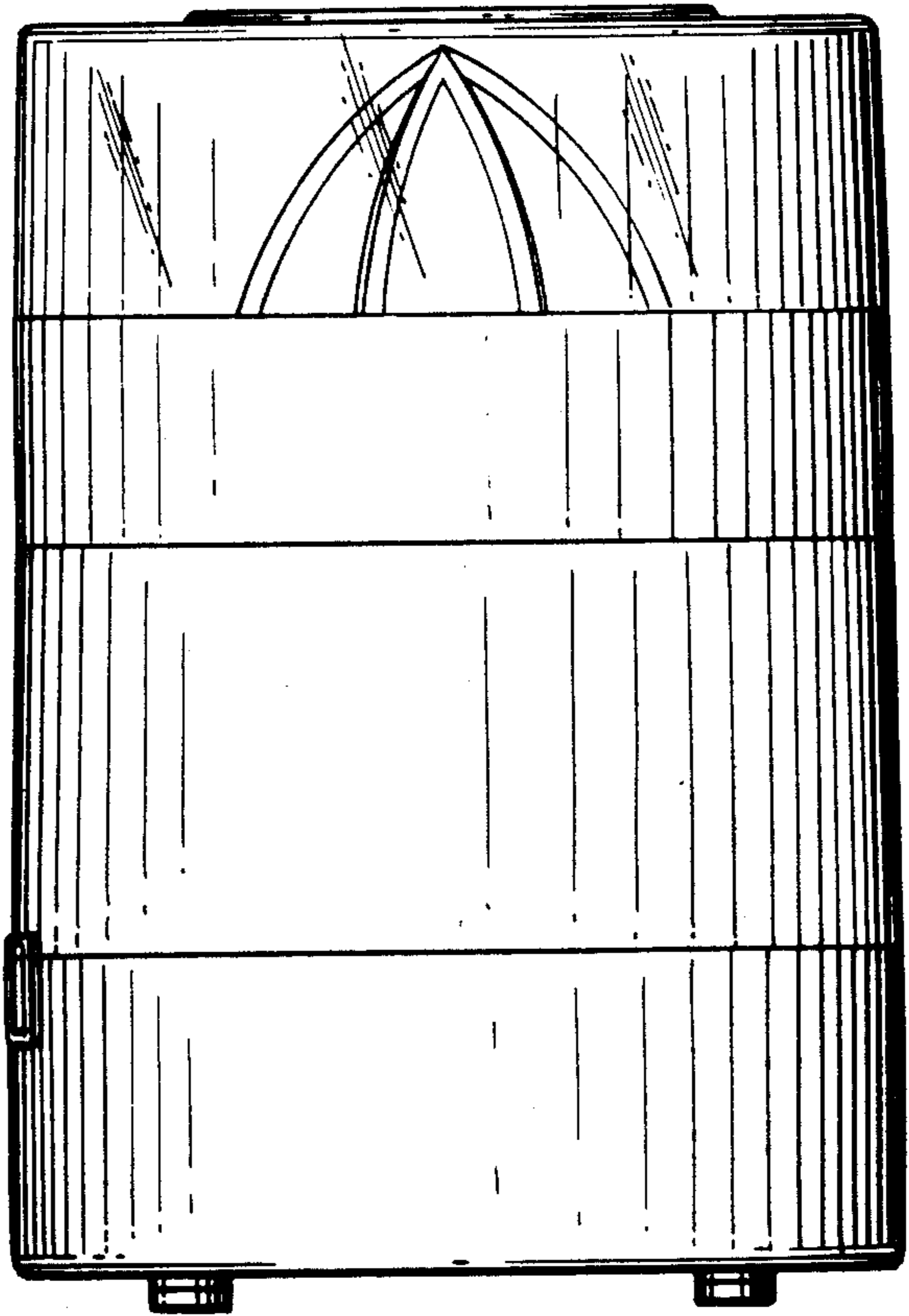

FIG. 7

