

[54] HIP PROSTHESIS

[75] Inventors: **James T. Treace, Dan H. Treace,**  
both of Germantown, Tenn.

[73] Assignee: **Richards Manufacturing Co., Inc.,**  
Memphis, Tenn.

[\*\*] Term: **14 Years**

[21] Appl. No.: **847,118**

[22] Filed: **Oct. 31, 1977**

[51] Int. Cl. .... **D24-03**

[52] U.S. Cl. .... **D24/33**

[58] Field of Search ..... **128/92 C; D24/33;**  
**3/1.912**

[56] **References Cited**

**U.S. PATENT DOCUMENTS**

D. 213,282	1/1969	Ring .....	D24/33
D. 235,485	6/1975	Amstutz .....	D24/33
3,813,699	6/1974	Giliberty .....	128/92 C
3,938,198	2/1976	Kahn et al. ....	128/92 C X
4,101,985	7/1978	Baumann et al. ....	3/1.912

**OTHER PUBLICATIONS**

Artificial Hip and Knee Joint Technology, ©1976, M. Schaldach et al., RD. 686.A38, p. 140, FIG. 1, "Charnley" Stem Prosthesis.

*Primary Examiner*—Bernard Ansher  
*Attorney, Agent, or Firm*—John R. Walker, III

[57] **CLAIM**

The ornamental design for a hip prosthesis, substantially as shown and described.

**DESCRIPTION**

FIG. 1 is a front elevational view of the hip prosthesis, showing our new design, the opposite side being substantially a mirror image thereof;  
FIG. 2 is a side elevational view thereof with the view being taken from the left side of FIG. 1;  
FIG. 3 is a side elevational view thereof with the view being taken from the right side of FIG. 1;  
FIG. 4 is a bottom plan view thereof;  
FIG. 5 is a top plan view thereof;  
FIG. 6 is a front elevation of a modified embodiment of the hip prosthesis illustrated in FIG. 1;  
FIG. 7 is a sectional view taken as on line VII—VII of FIG. 1;  
FIG. 8 is a sectional view taken as on line VIII—VIII of FIG. 1;  
FIG. 9 is a sectional view taken as on line IX—IX of FIG. 1;  
FIG. 10 is a sectional view taken as on line X—X of FIG. 1;  
FIG. 11 is a sectional view taken as on line XI—XI of FIG. 6;  
FIG. 12 is a sectional view taken as on line XII—XII of FIG. 6;  
FIG. 13 is a sectional view taken as on line XIII—XIII of FIG. 6; and  
FIG. 14 is a sectional view taken as on line XIV—XIV of FIG. 6.

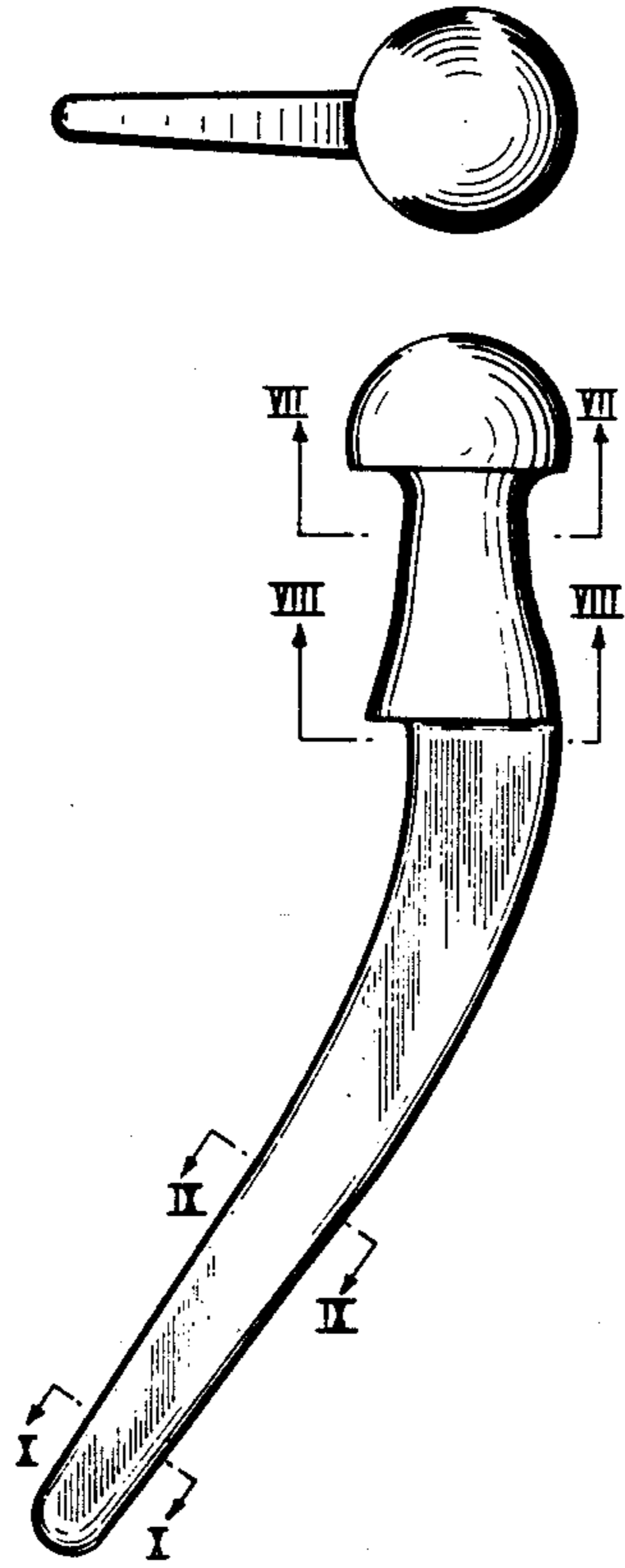

FIG. 4

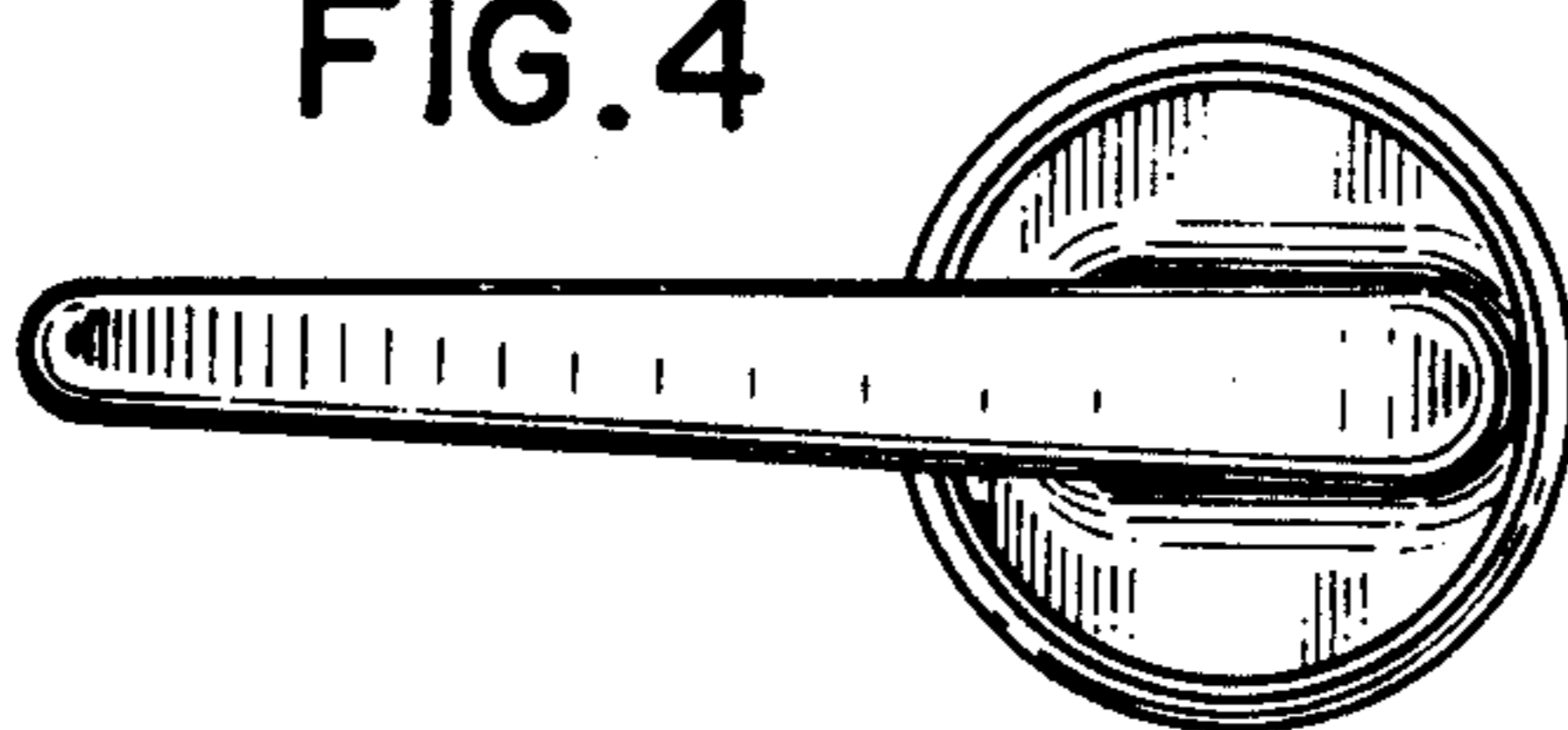

FIG. 5

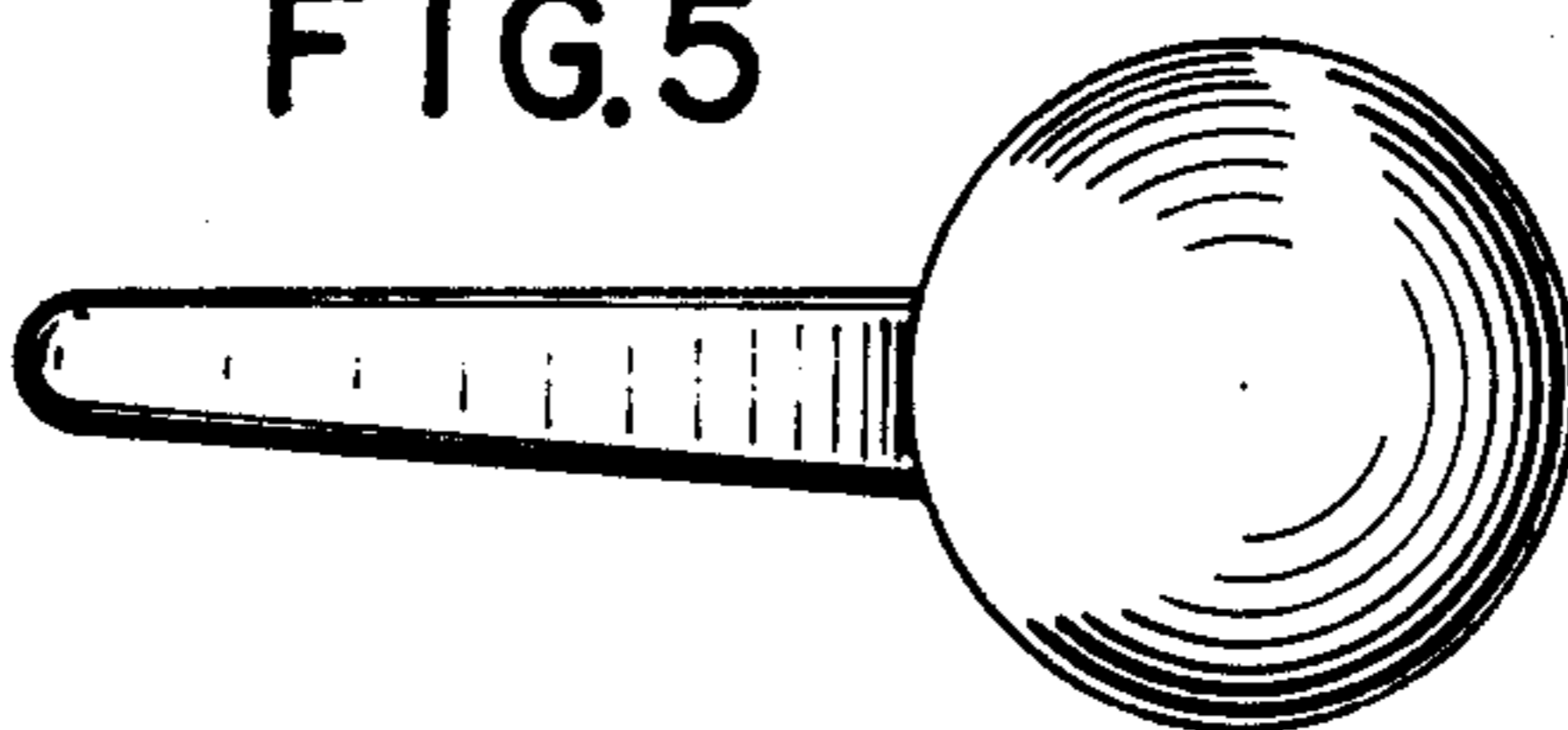

FIG. 2

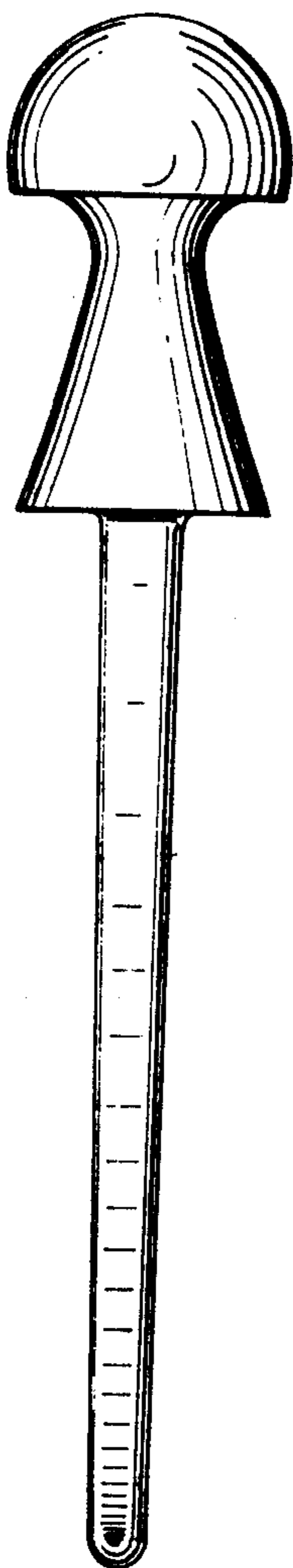

FIG. 3

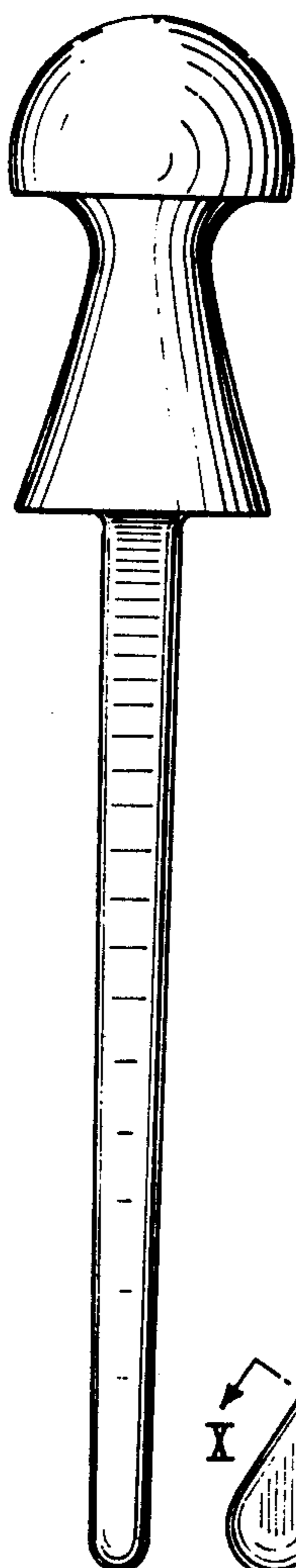

FIG. 1

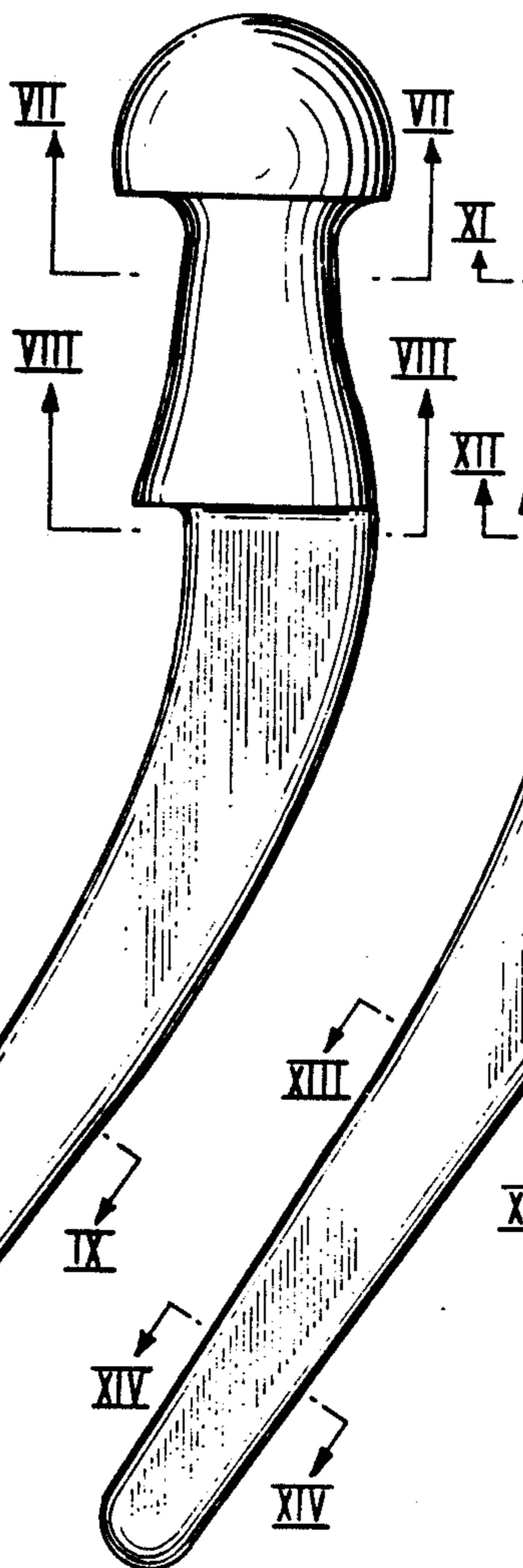

FIG. 6

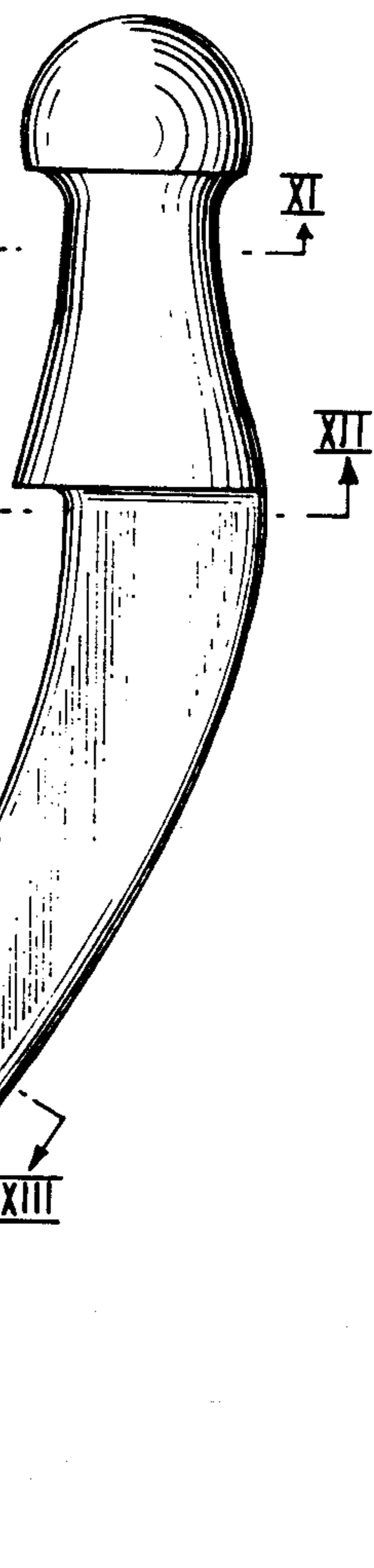

FIG. 7

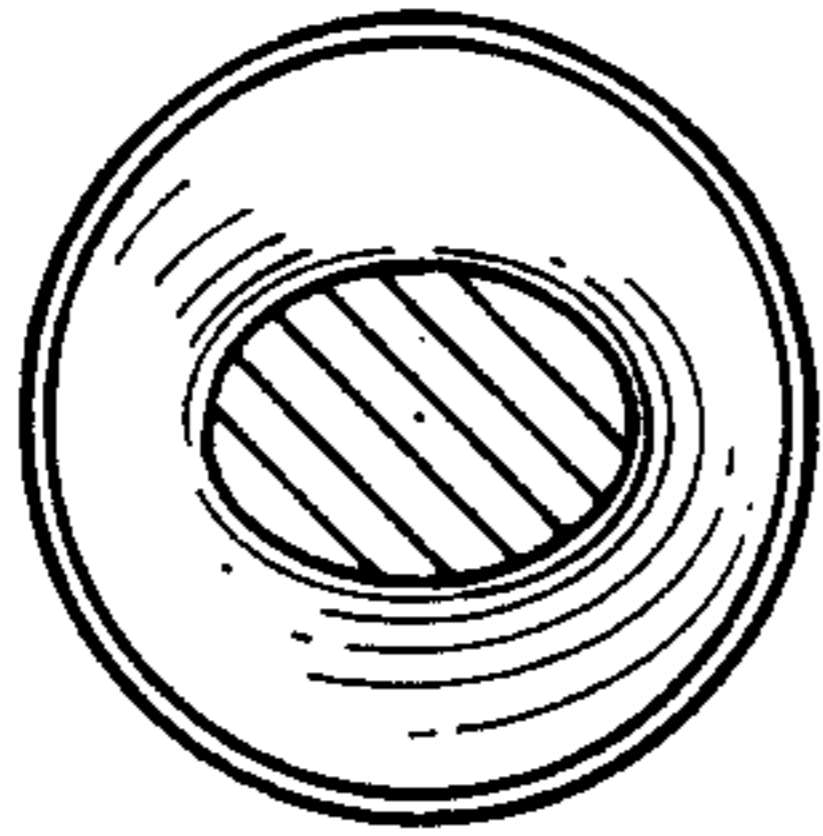

FIG. 11

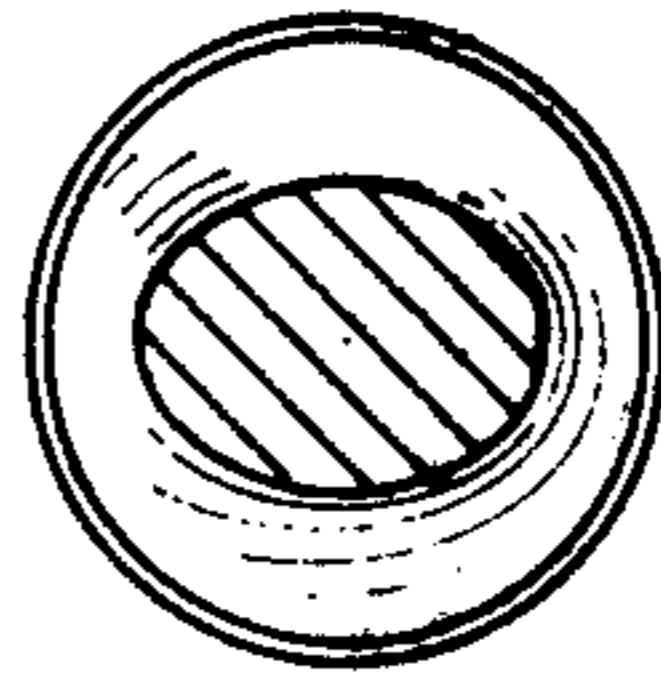

FIG. 8

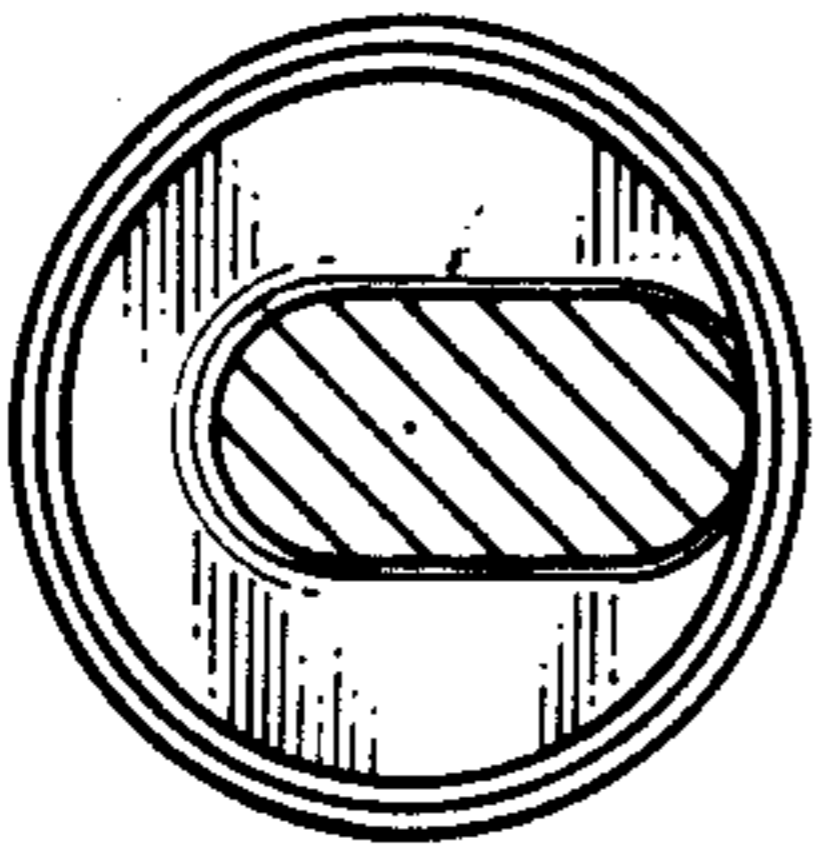

FIG. 12

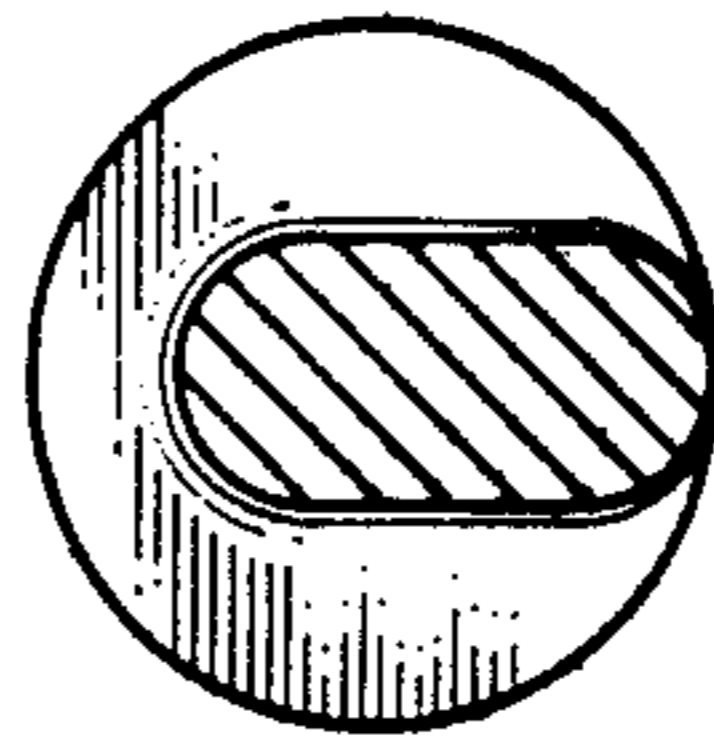

FIG. 9



FIG. 13



FIG. 10



FIG. 14

