

[54] JUICER

3,186,458 6/1965 Takei et al. D7/49 X

[75] Inventors: **Massao Tsuji**, North Plainfield;
Ronald L. Muller, New Milford, both
of N.J.

[73] Assignee: **North American Philips Corporation**,
New York, N.Y.

[**] Term: **14 Years**

[21] Appl. No.: **790,028**

[22] Filed: **Apr. 22, 1977**

[51] Int. Cl. **D7-04**

[52] U.S. Cl. **D7/49**

[58] Field of Search **D7/48, 49; 99/501, 502,**
99/503, 504, 505, 506, 485

[56] **References Cited**

U.S. PATENT DOCUMENTS

D. 226,345	2/1973	Greubel	D7/49
D. 249,441	9/1978	Fukumoto	D7/49
1,894,858	1/1933	Fromm	D7/49 X

OTHER PUBLICATIONS

Home Furnishings Daily, Jul. 14, 1975, p. 22, top left
corner, Waring Fruit Juicer.

Industrial Design, Jul.-Aug. 1973, p. 60, AEPI Ice Gra-
ter/Juicer, bottom half of page.

Primary Examiner—Winifred E. Herrmann
Attorney, Agent, or Firm—Frank R. Trifari

[57] **CLAIM**

The ornamental design for a juicer, as shown and de-
scribed.

DESCRIPTION

FIG. 1 is a perspective view of a juicer showing our
new design;

FIG. 2 is a top plan view thereof;

FIG. 3 is a front elevational view thereof, the rear ele-
vational view being a mirror image;

FIG. 4 is a bottom plan view thereof;

FIG. 5 is a left-side elevational view thereof; and

FIG. 6 is a right-side elevational view thereof.

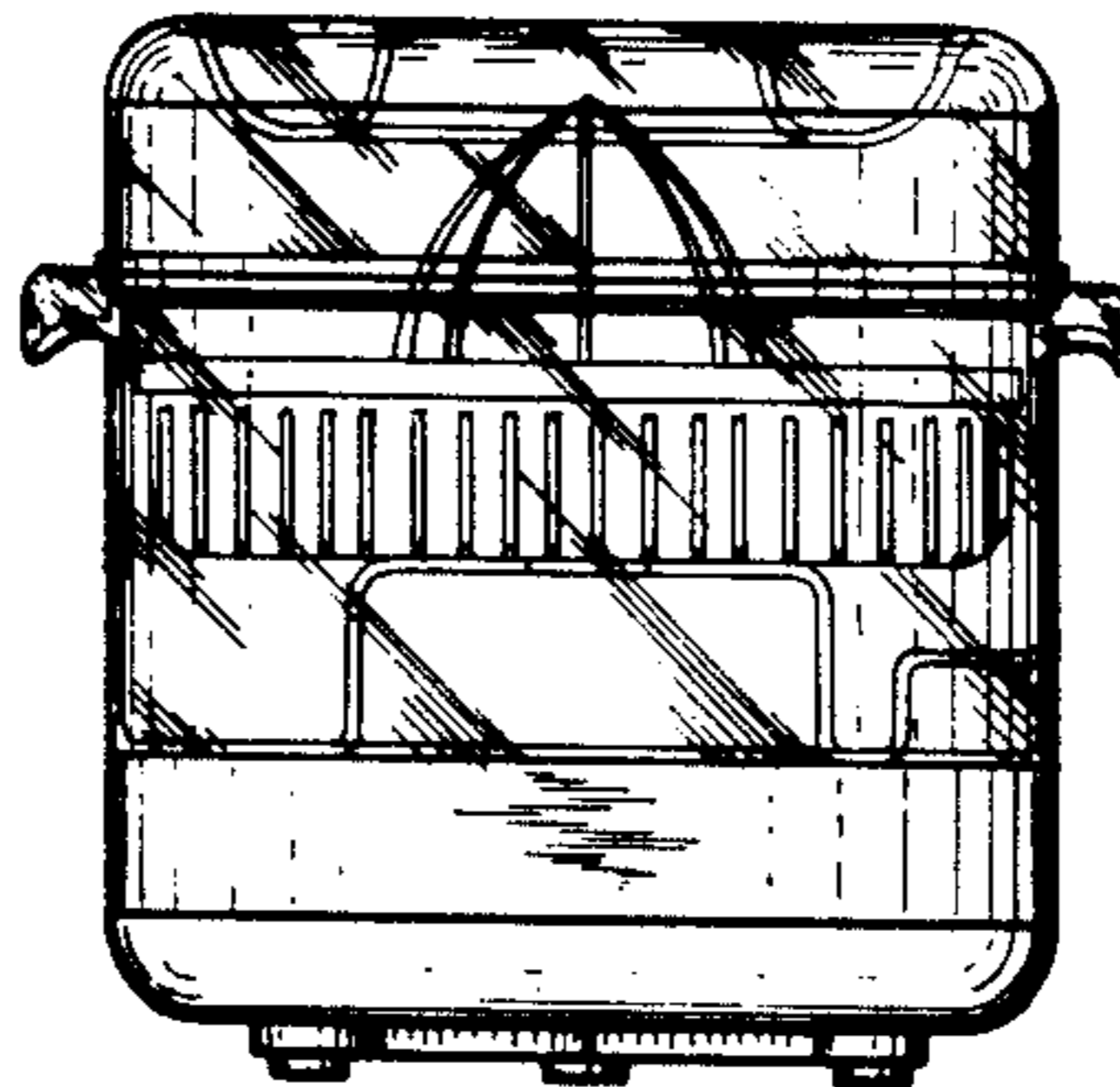
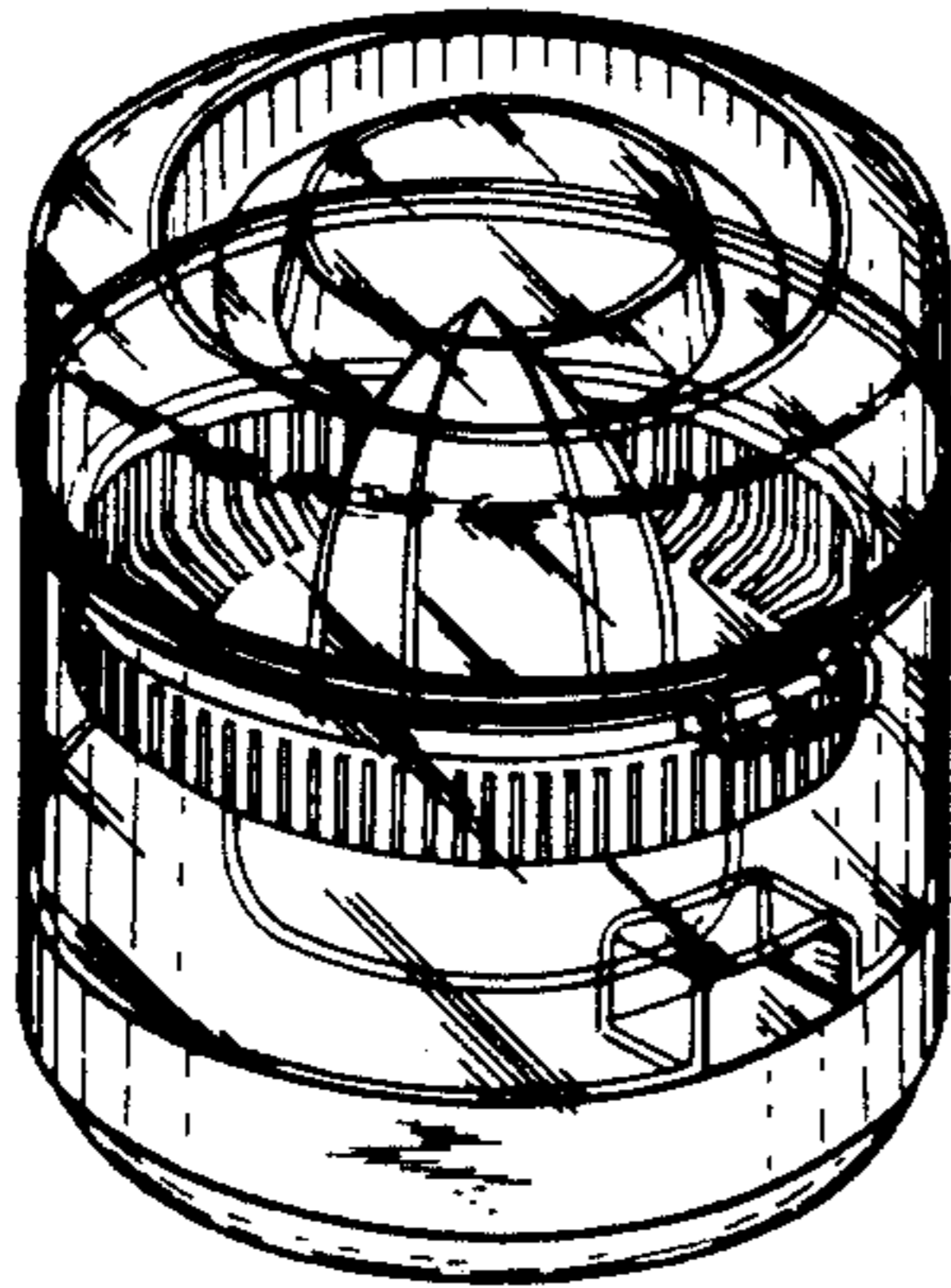

FIG. 1.

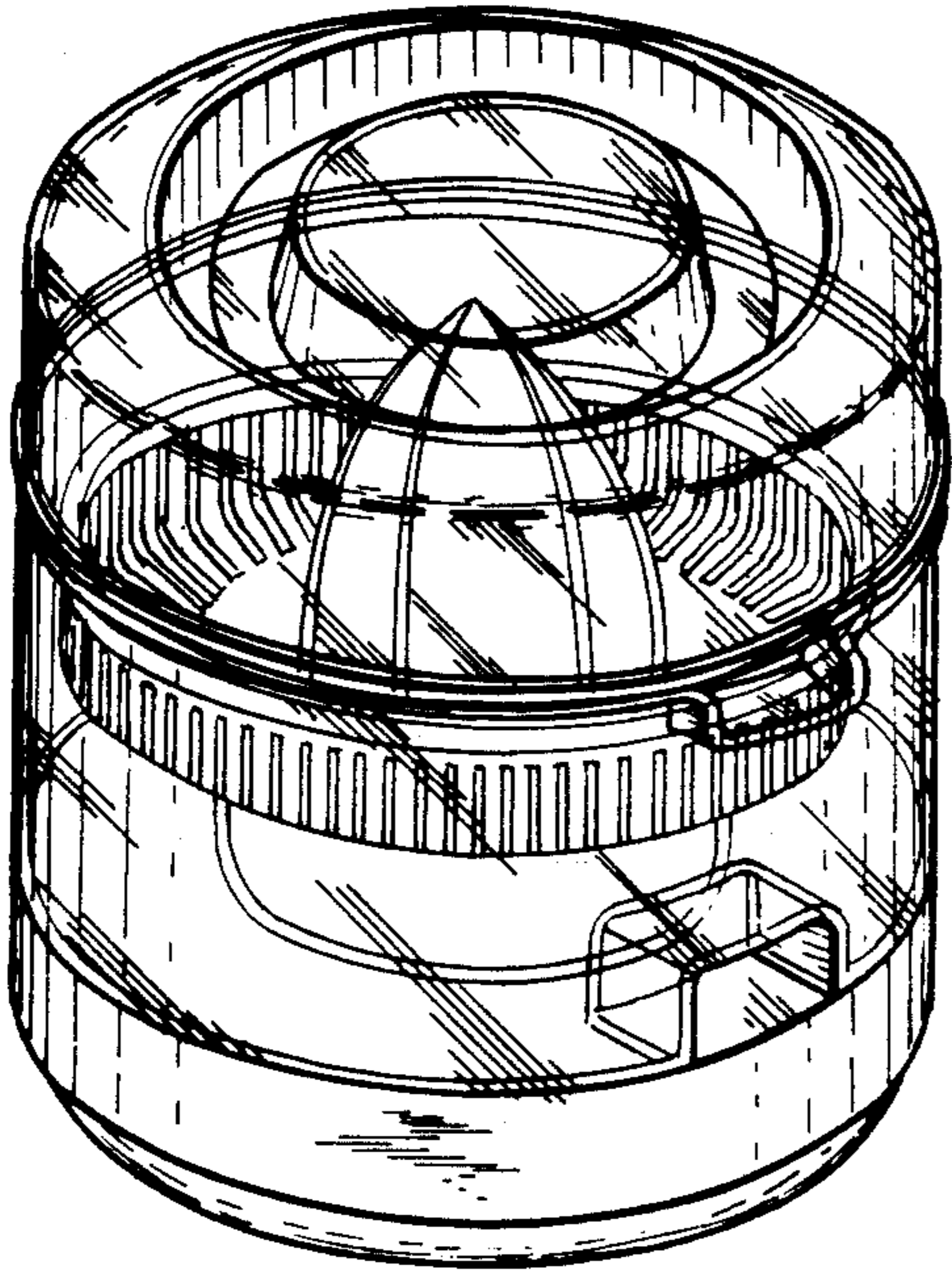

FIG. 2.

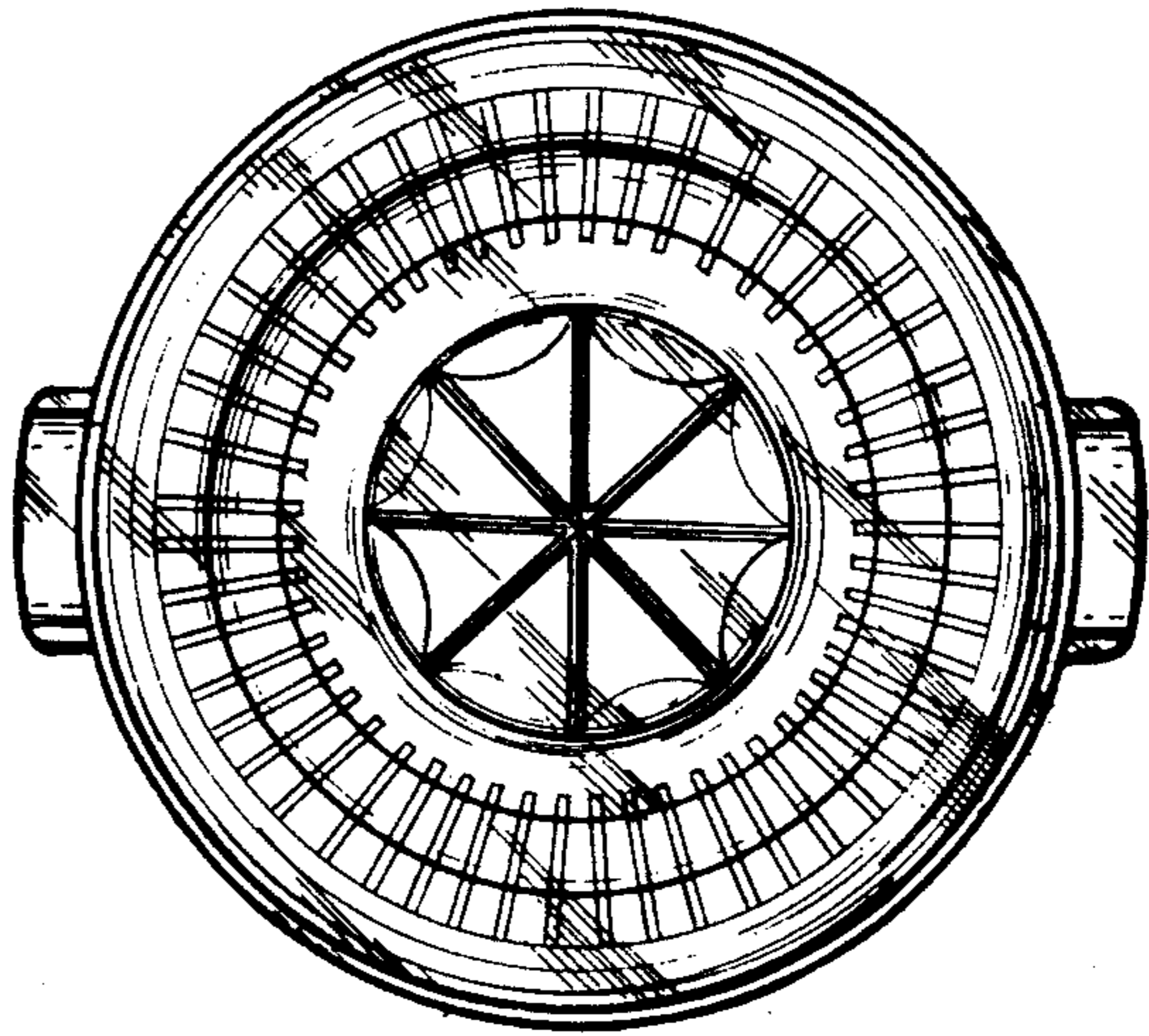

FIG. 3.

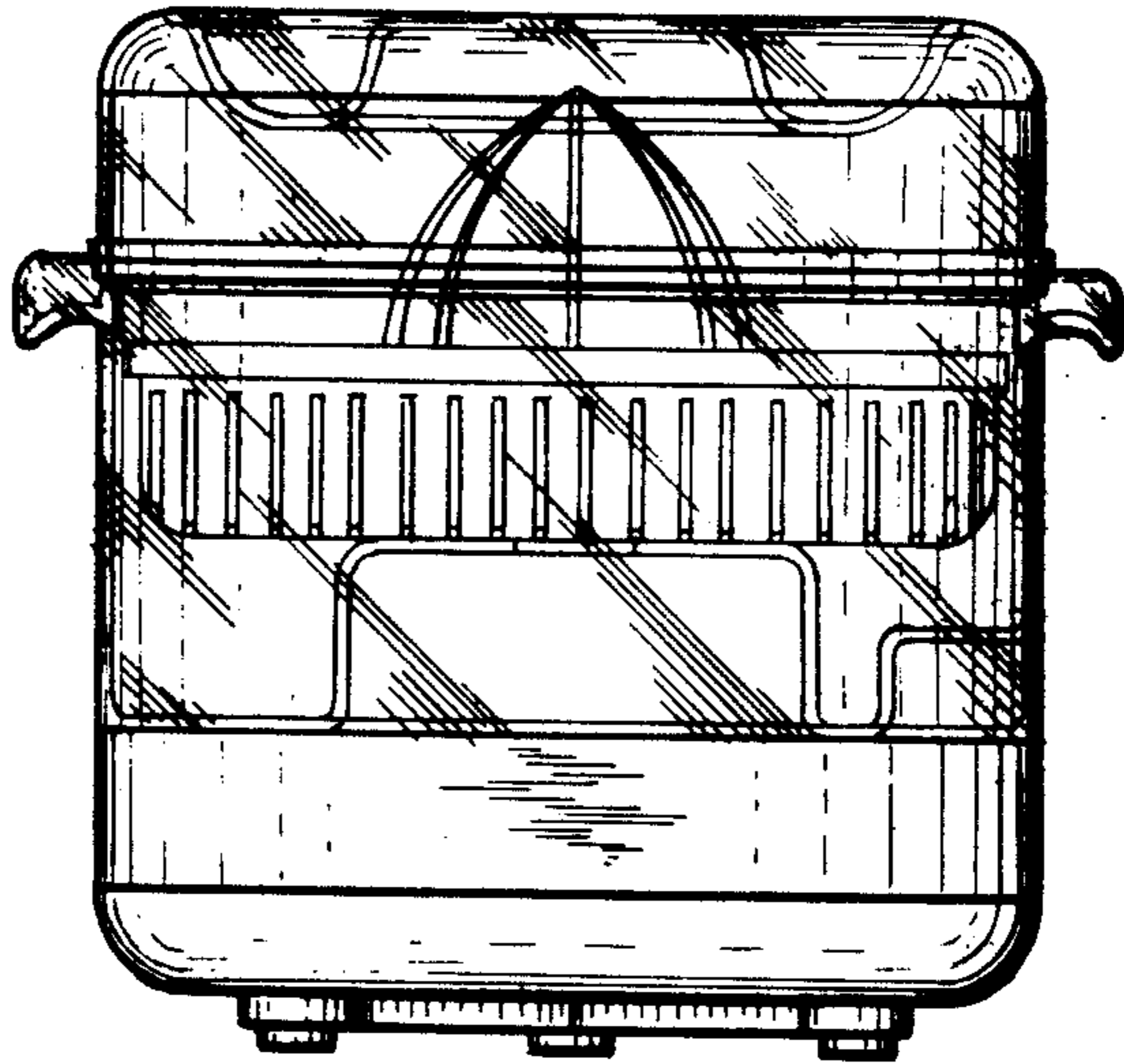

FIG. 4.

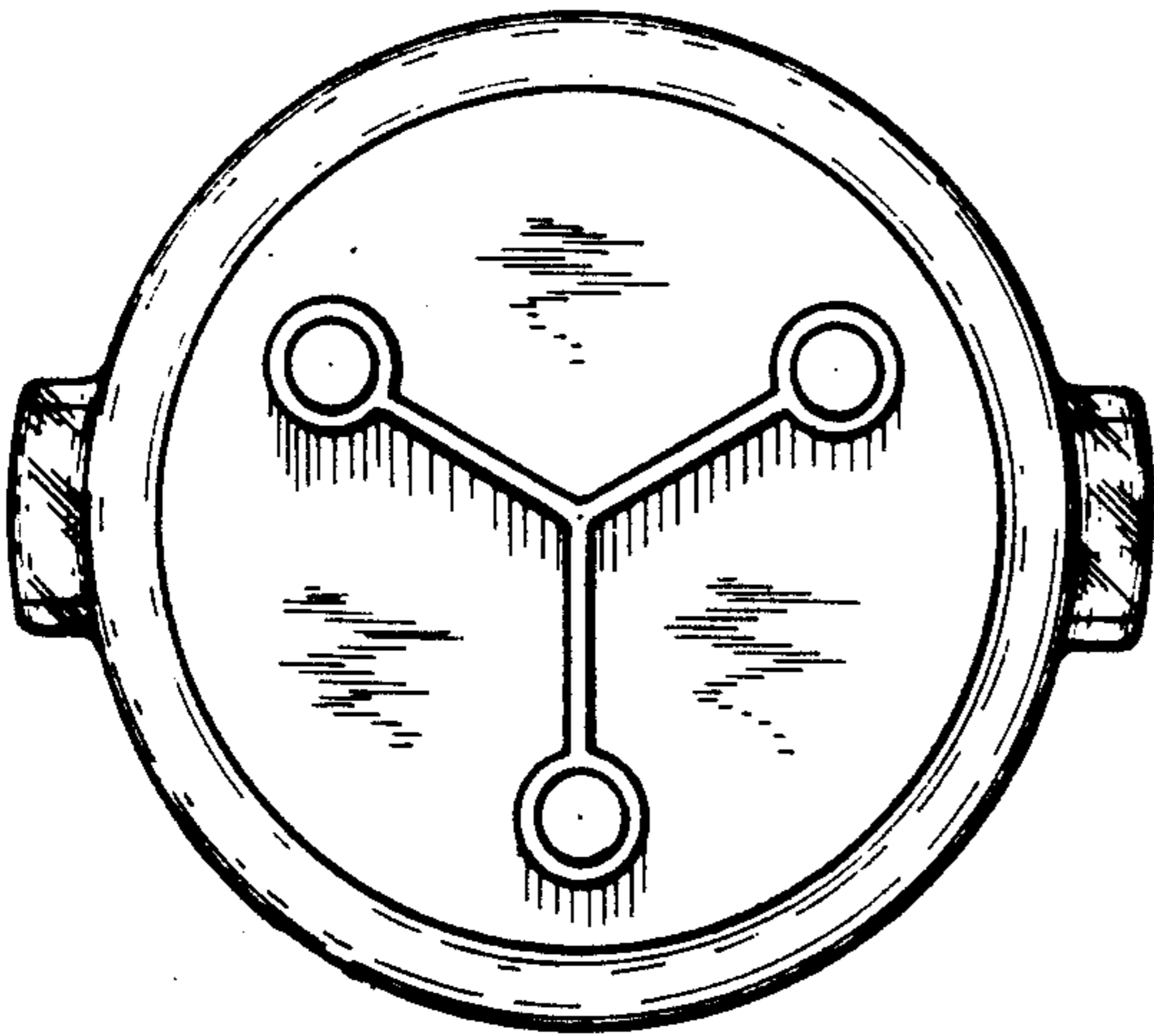

FIG. 5.

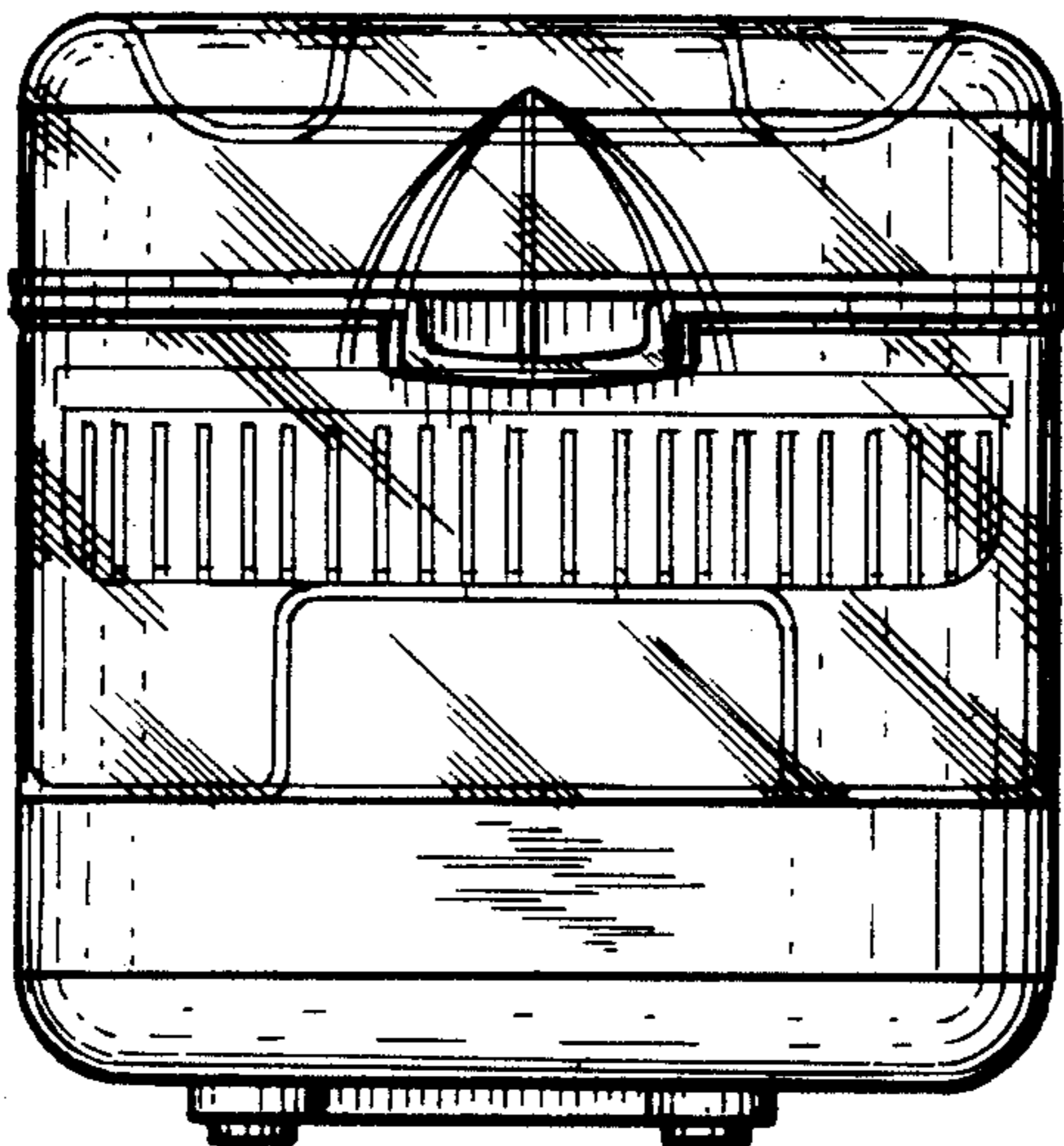

FIG. 6.

