

[54] **HYDROTHERAPY SPA**
 [75] Inventor: **Richard G. Reineman**, Newport Beach, Calif.
 [73] Assignee: **Marlin Fiberglass**, Huntington Beach, Calif.
 [**] Term: **14 Years**
 [21] Appl. No.: **36,656**
 [22] Filed: **May 7, 1979**

D. 243,691	3/1977	Gruber	D23/55
D. 245,542	8/1977	Melchior	D25/2 X
D. 247,577	3/1978	Di Giacomo	D24/38
D. 247,977	5/1978	Jacuzzi	D24/38
3,496,579	2/1970	Petersen	4/173
3,688,775	9/1972	Raymann	128/366
3,952,338	4/1976	Traxclair	4/172.15

Primary Examiner—Bernard Ansher
Attorney, Agent, or Firm—Knobbe, Martens, Olson, Hubbard & Bear

Related U.S. Application Data

[63] Continuation of Ser. No. 5,820, Jan. 23, 1979, abandoned.
 [51] Int. Cl. **D23—02; D24—02**
 [52] U.S. Cl. **D24/38; D23/55; D25/2**
 [58] Field of Search **D24/36, 38; D23/55, D23/48, 49, 52; D25/2; 128/366, 66; 4/172, 173, 178, 172.19, 177**

References Cited

U.S. PATENT DOCUMENTS

D. 206,143	11/1966	Jacuzzi	D24/36 X
D. 216,194	12/1969	Benson	D23/55
D. 238,071	12/1975	Ganger	D23/55
D. 240,084	5/1976	Melchior	D24/38 X

[57] **CLAIM**

The ornamental design for a hydrotherapy spa, as shown.

DESCRIPTION

FIG. 1 is a top perspective view of a hydrotherapy spa showing my new design;
 FIG. 2 is a perspective view thereof, taken from a different angle;
 FIG. 3 is a top plan view thereof;
 FIG. 4 is a cross-sectional view thereof, taken along line 4—4 of FIG. 3;
 FIG. 5 is a cross-sectional view thereof, taken along line 5—5;
 FIG. 6 is a cross-sectional view taken along line 6—6; and
 FIG. 7 is a cross-sectional view thereof, taken along line 7—7.

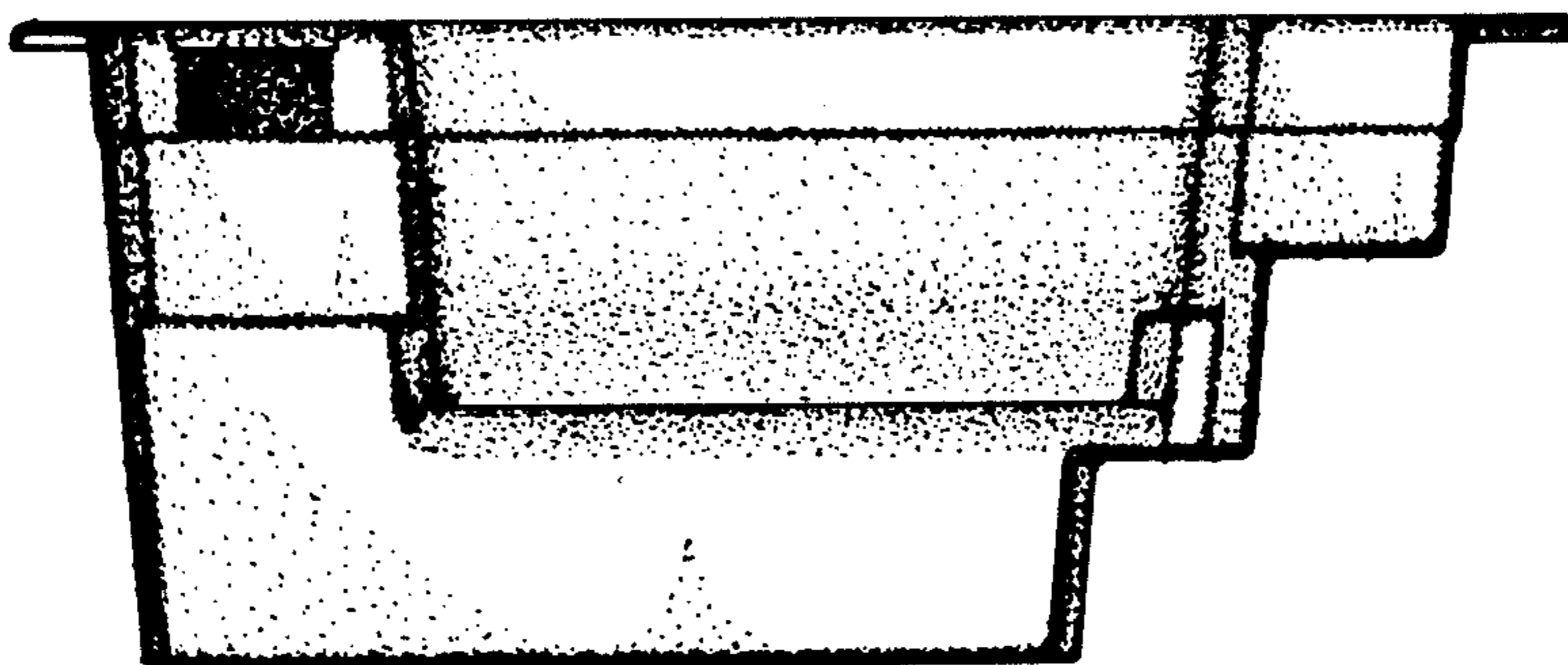
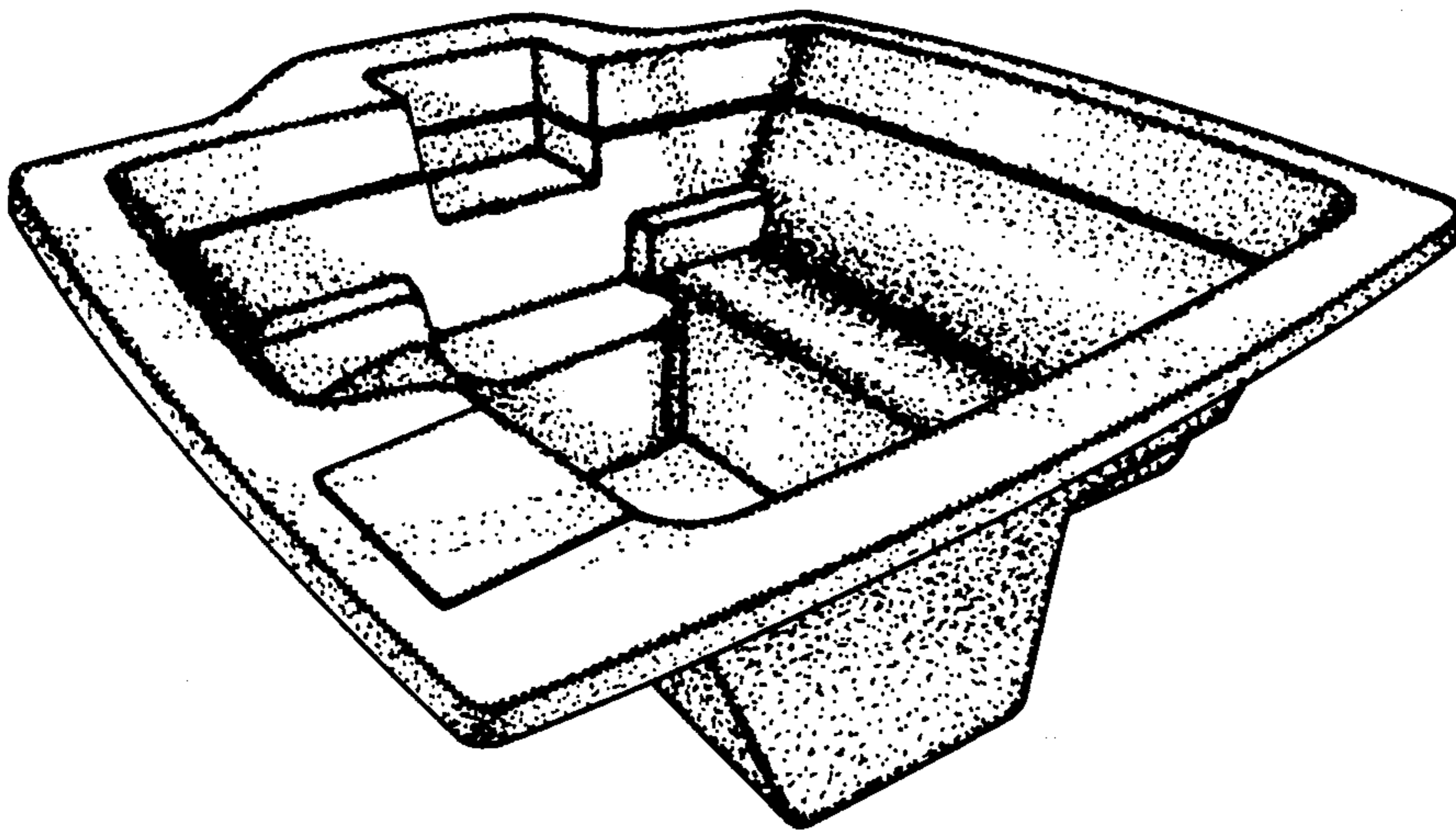

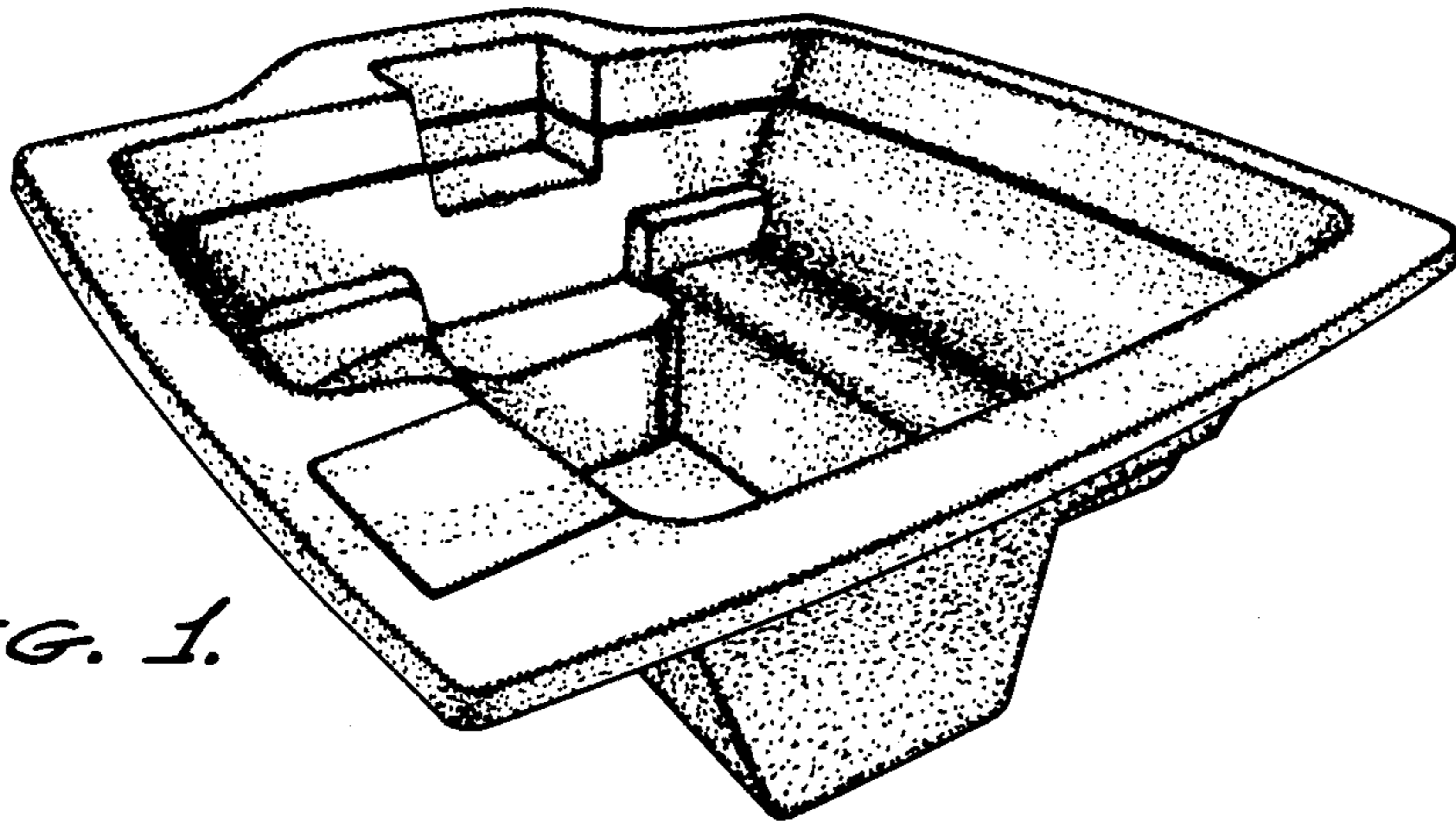

FIG. 1.

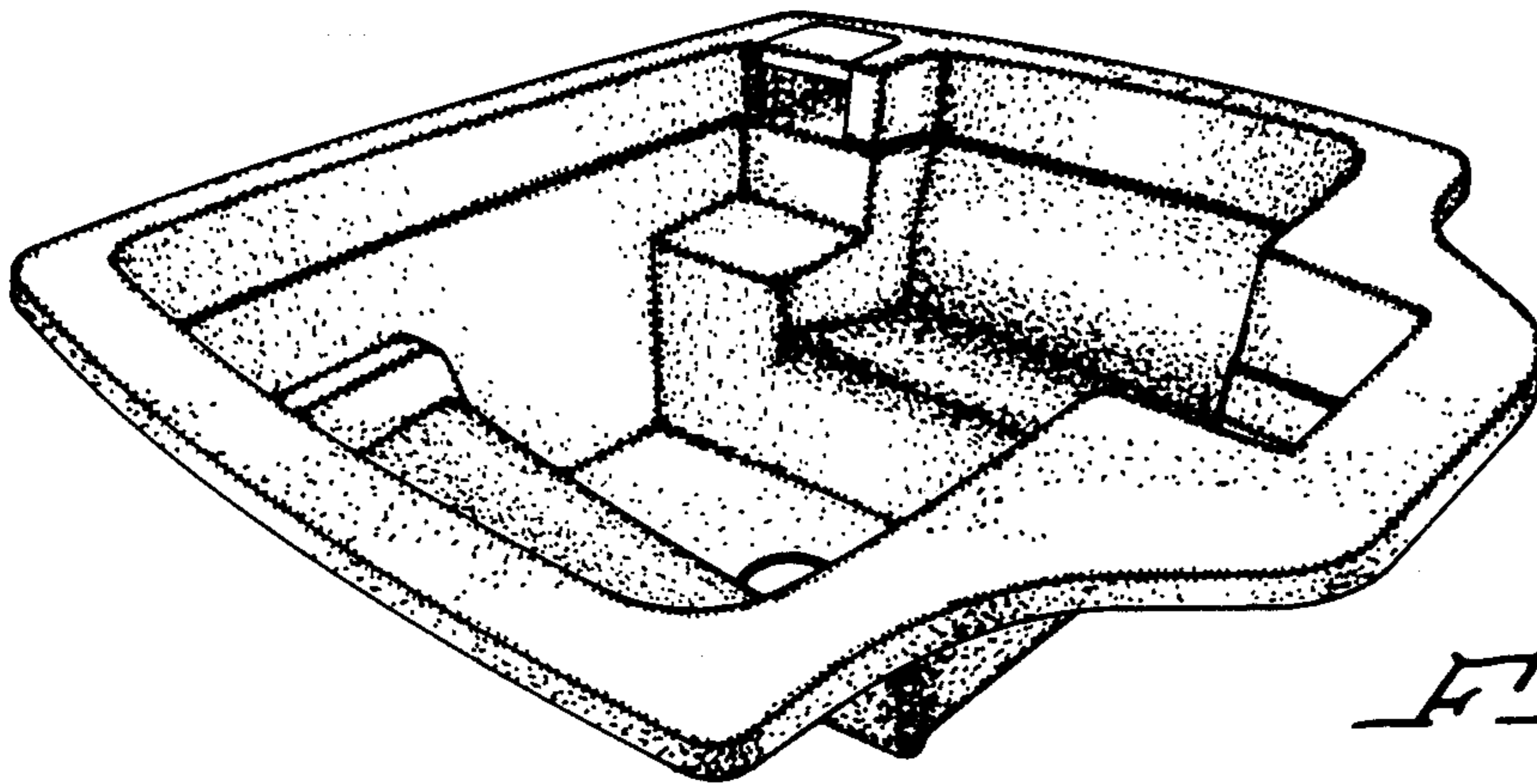
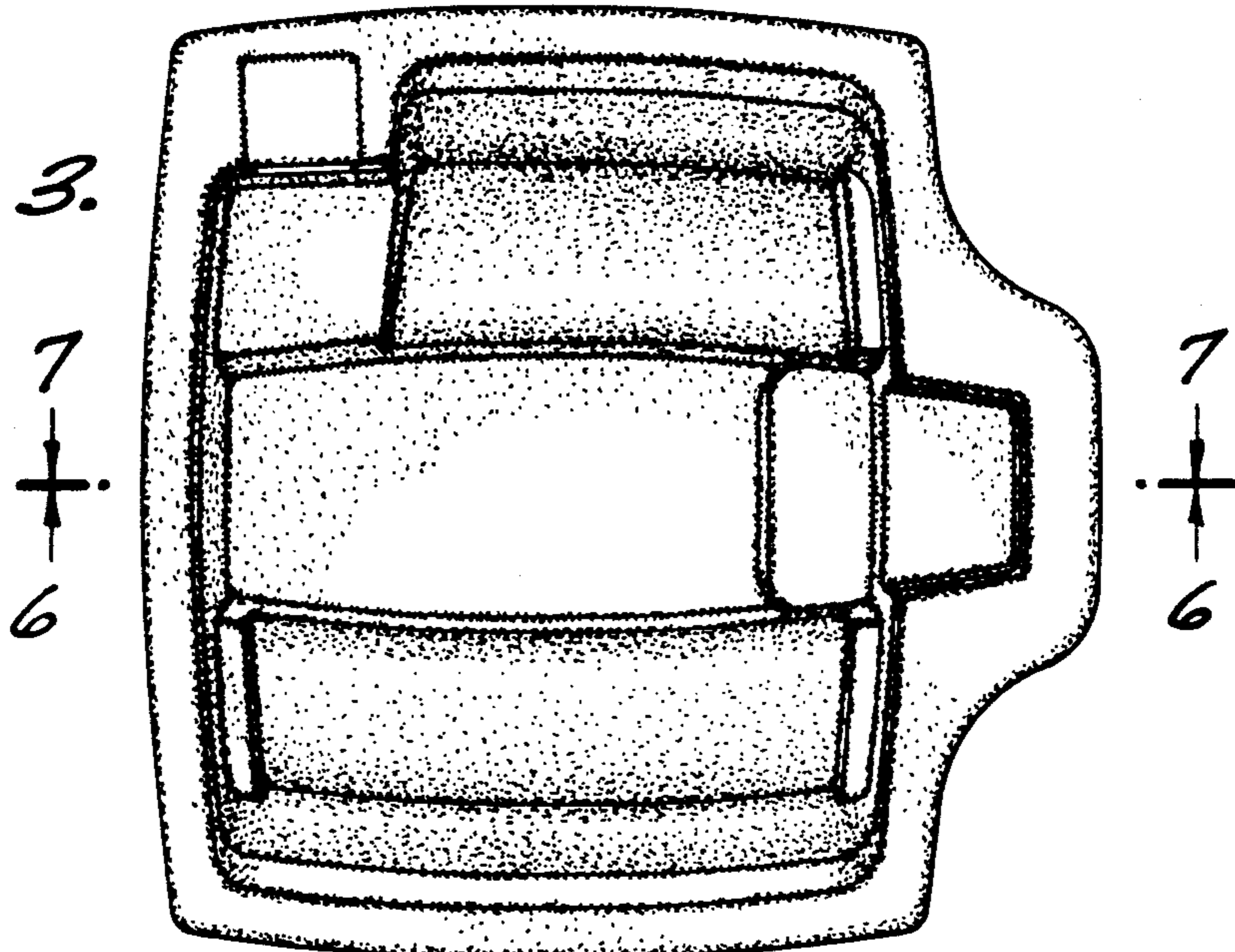

FIG. 2.

5-4

FIG. 3.



7
6

7
6

5-4

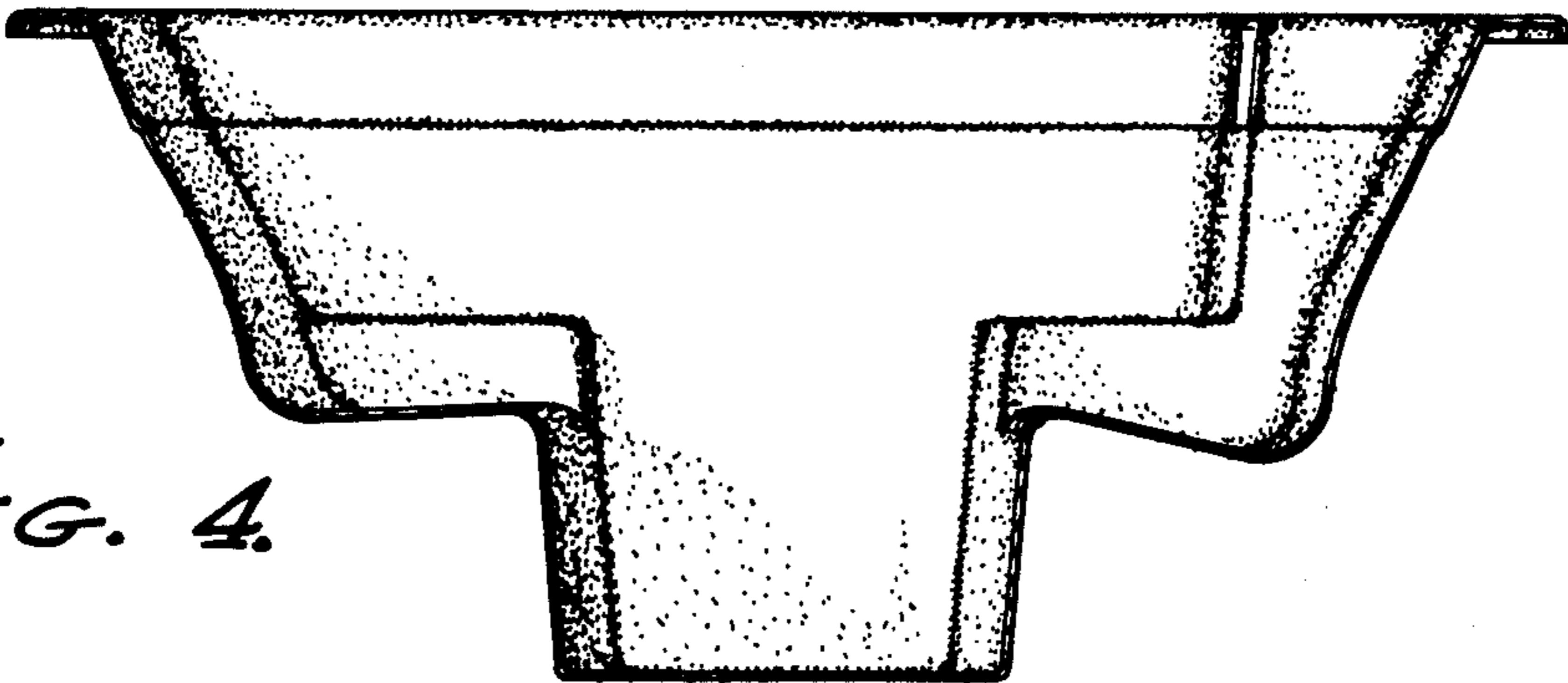

FIG. 4.

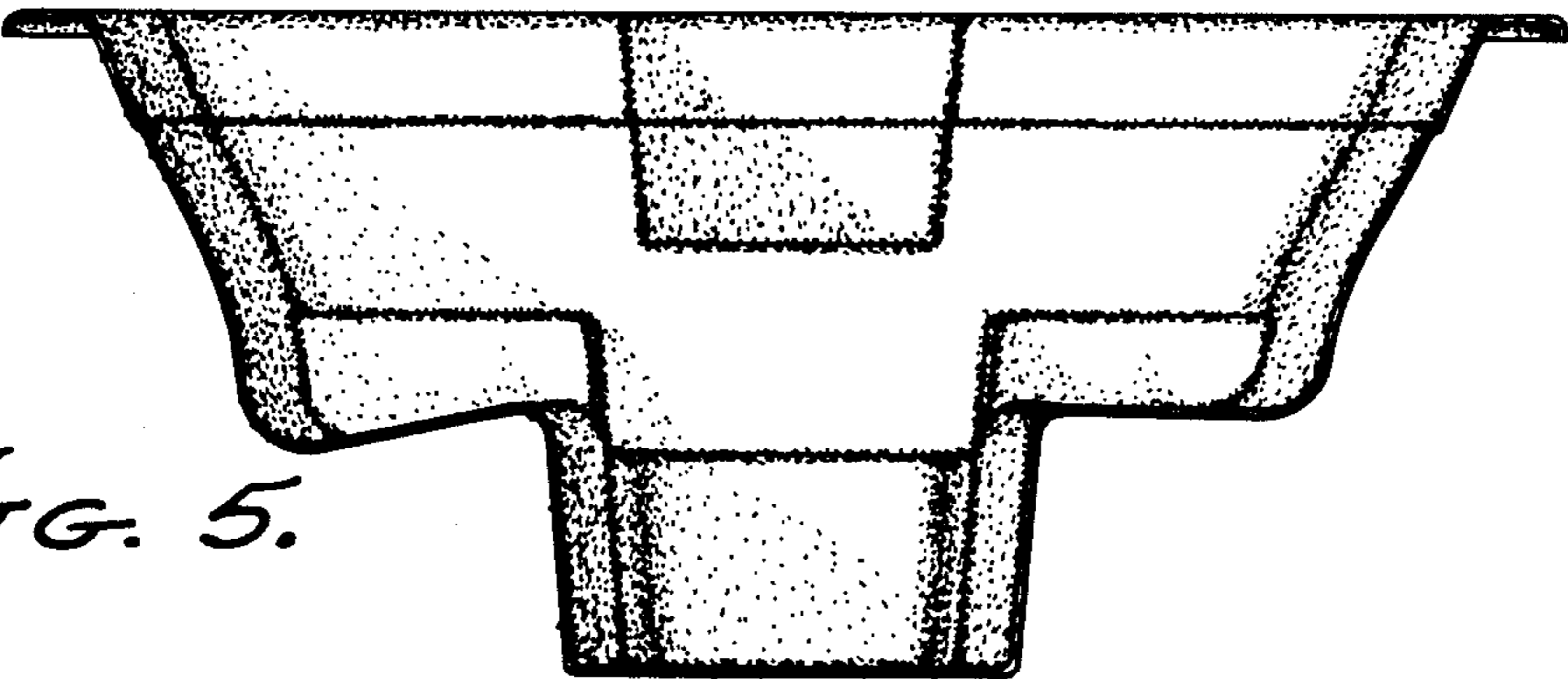

FIG. 5.

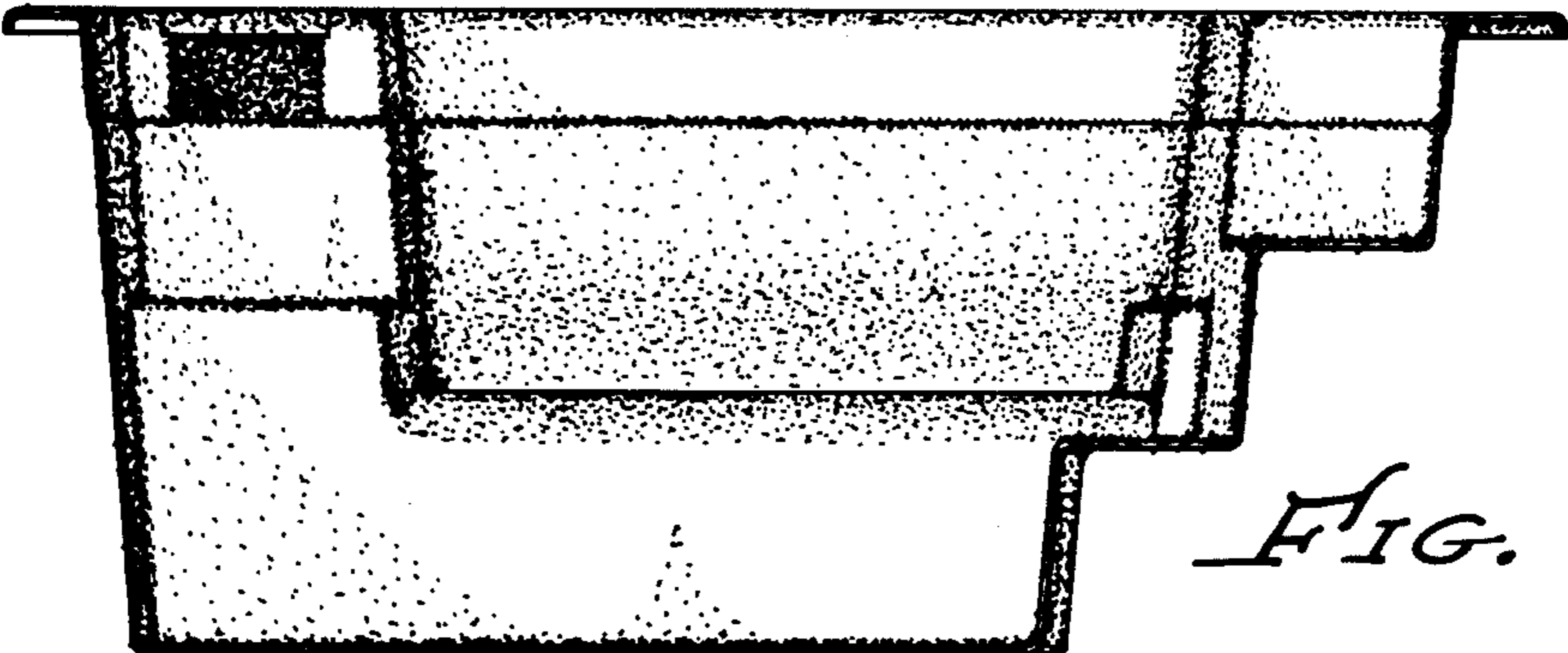

FIG. 6.

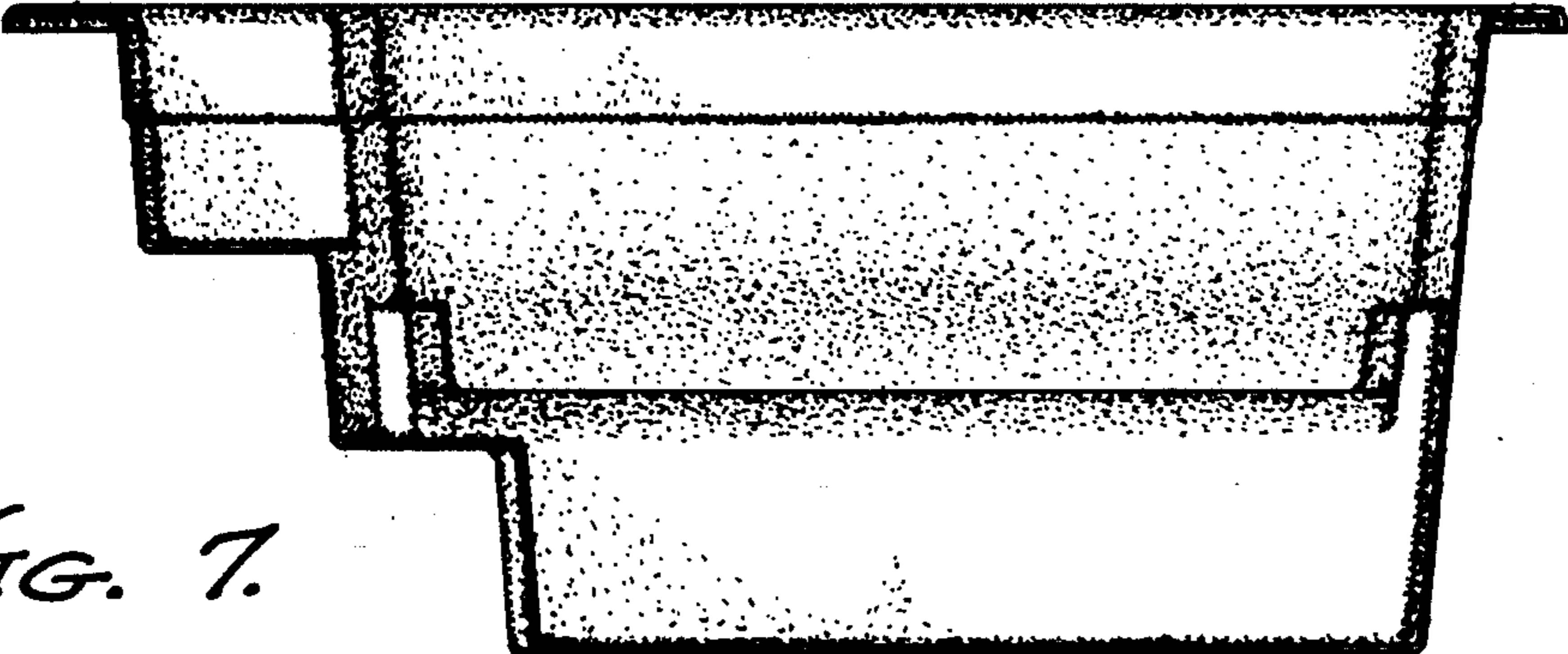

FIG. 7.