

[54] COMBINED FERTILIZER AND PESTICIDE APPLICATOR FOR PLANTS

[75] Inventors: Richard L. Parish; James D. Amerine, both of Marysville, Ohio

[73] Assignee: O. M. Scott & Sons Company, Marysville, Ohio

[**] Term: 14 Years

[21] Appl. No.: 843,119

[22] Filed: Oct. 17, 1977

[51] Int. Cl. D8-05

[52] U.S. Cl. D8/2

[58] Field of Search 222/240, 31, 74, 324; D8/2

[56] References Cited

U.S. PATENT DOCUMENTS

- D. 175,627 9/1955 Martin D8/2
- D. 190,742 6/1961 Roberts D8/2

- D. 192,600 4/1962 Love, Jr. D8/2
- D. 192,601 4/1962 Love, Jr. D8/2
- D. 197,077 12/1963 Harris D8/2
- 2,957,268 10/1960 Santarelli 222/240 X
- 2,978,146 4/1961 Packwood, Jr. 222/240 X

Primary Examiner—Bernard Ansher
Attorney, Agent, or Firm—Walter J. Baum

[57] CLAIM

The ornamental design for a combined fertilizer and pesticide applicator for plants, substantially as shown and described.

DESCRIPTION

FIG. 1 is a front elevational view of a combined fertilizer and pesticide applicator for plants, showing my new design;

FIG. 2 is an elevational view of one side thereof;

FIG. 3 is an elevational view of the opposite side thereof;

FIG. 4 is a plan view thereof; and

FIG. 5 is a bottom view thereof.

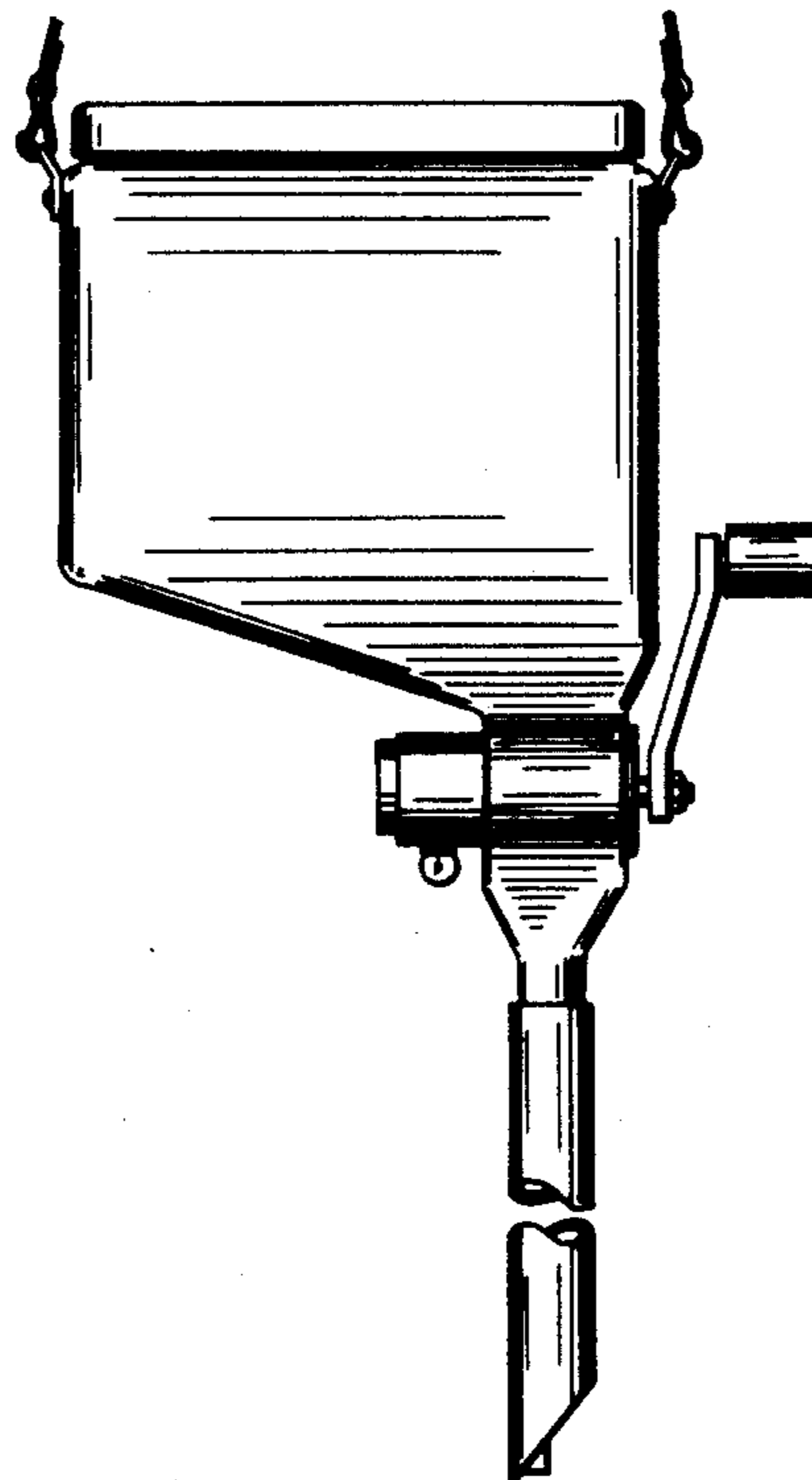
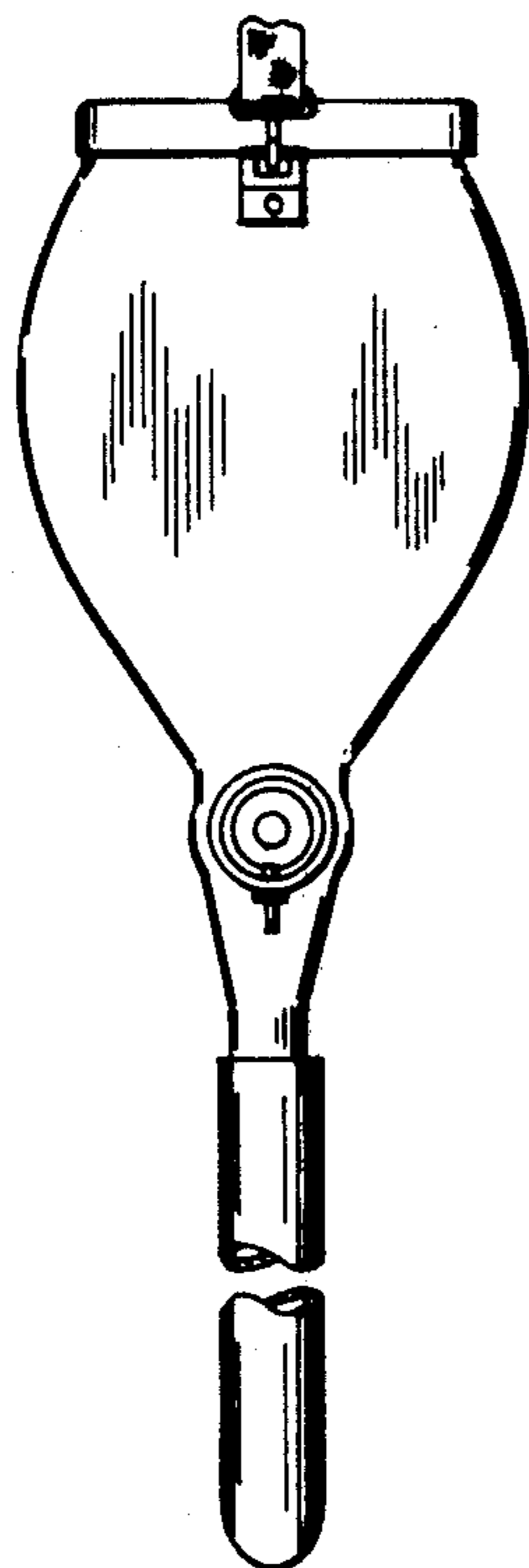

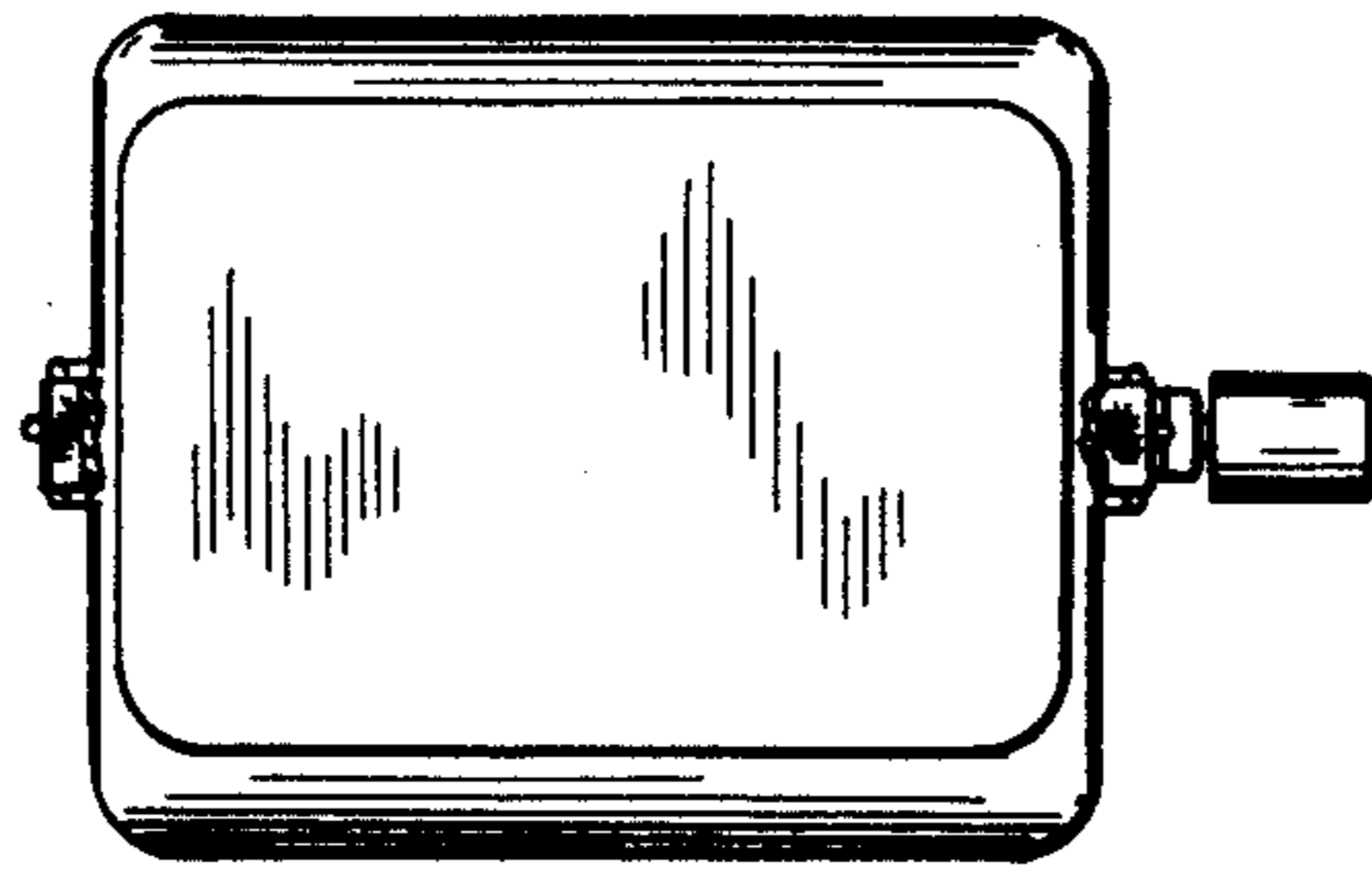

FIG. 4

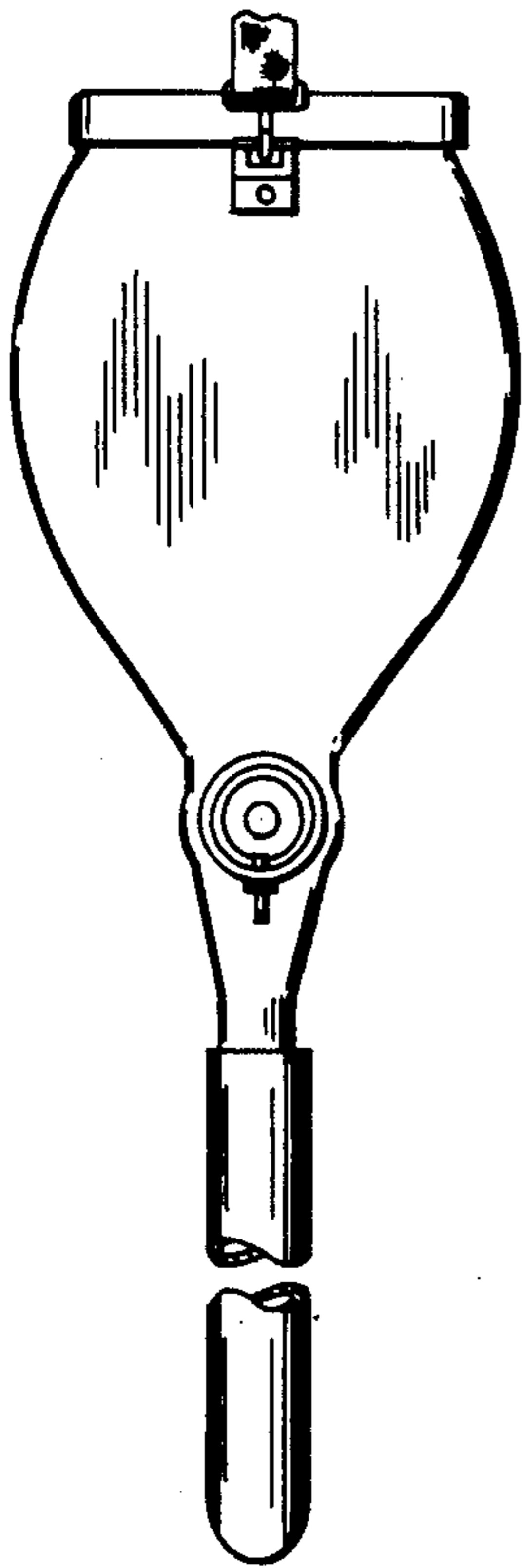

FIG. 2

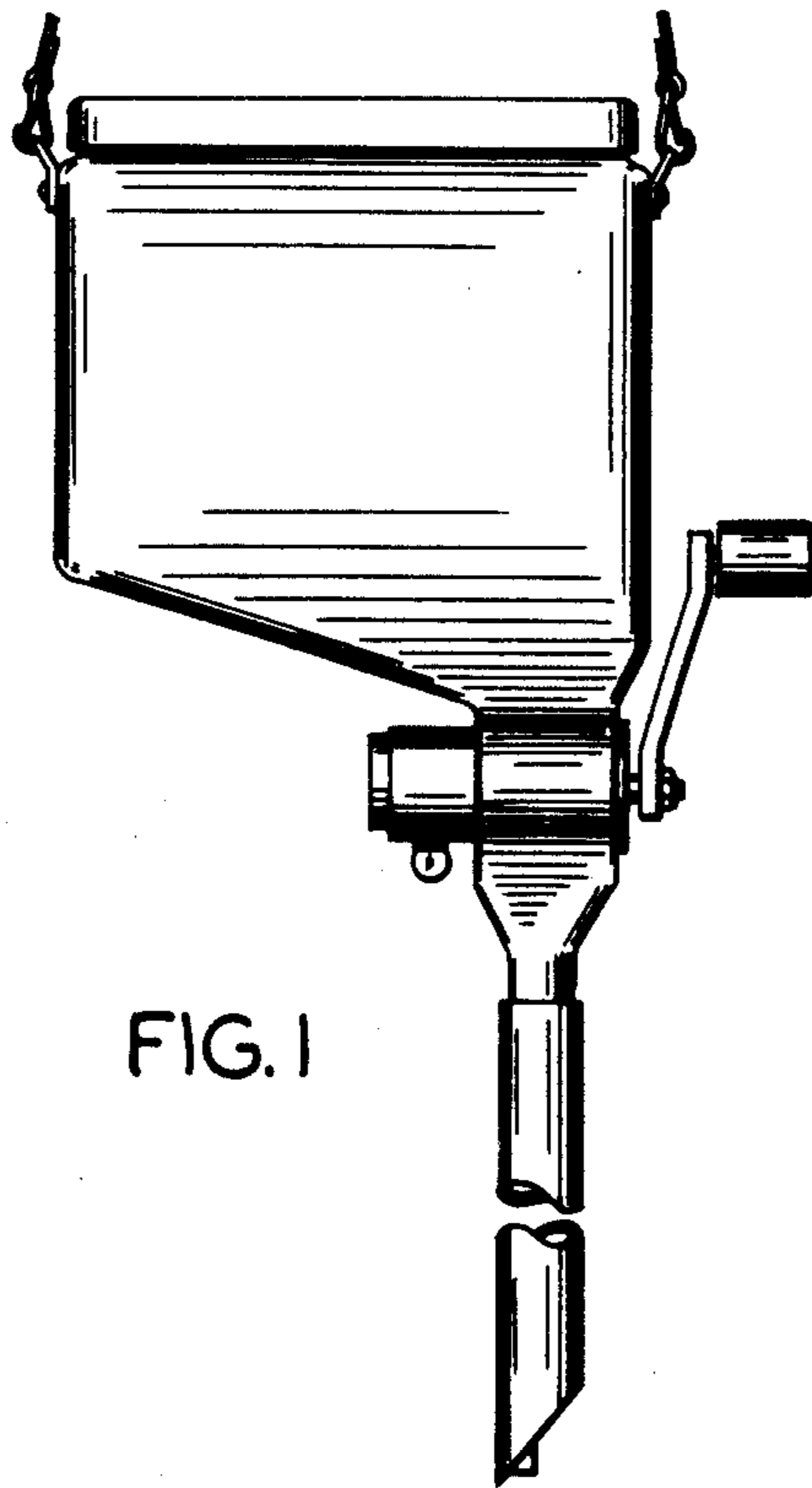

FIG. 1

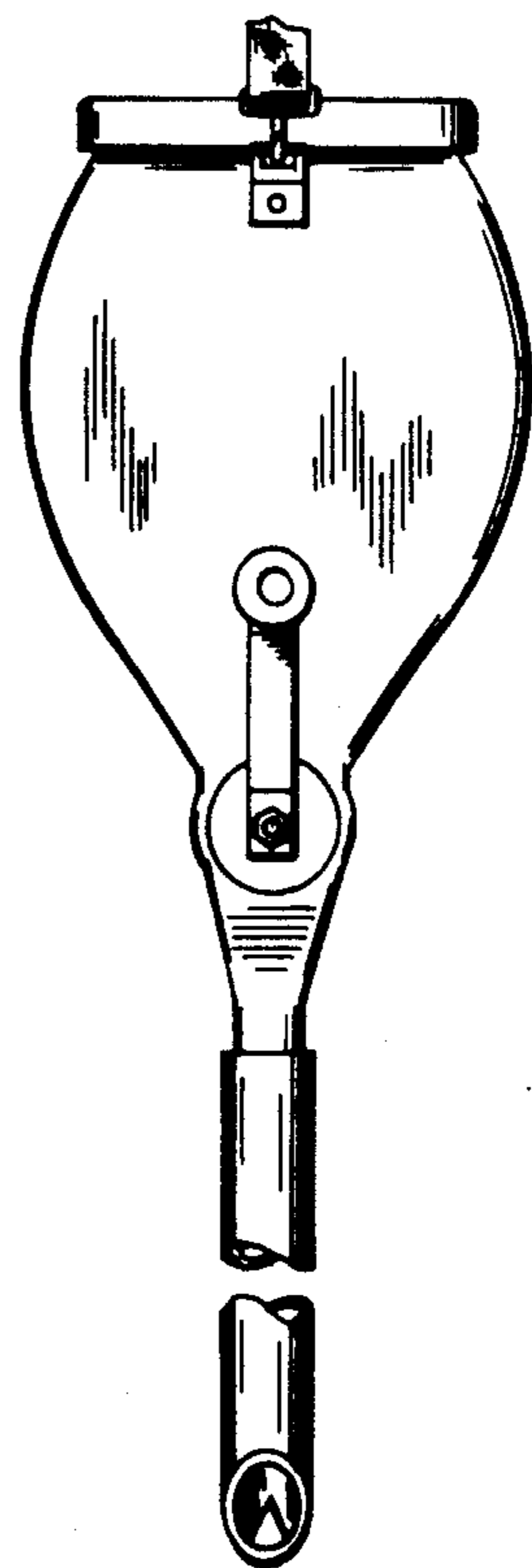

FIG. 3

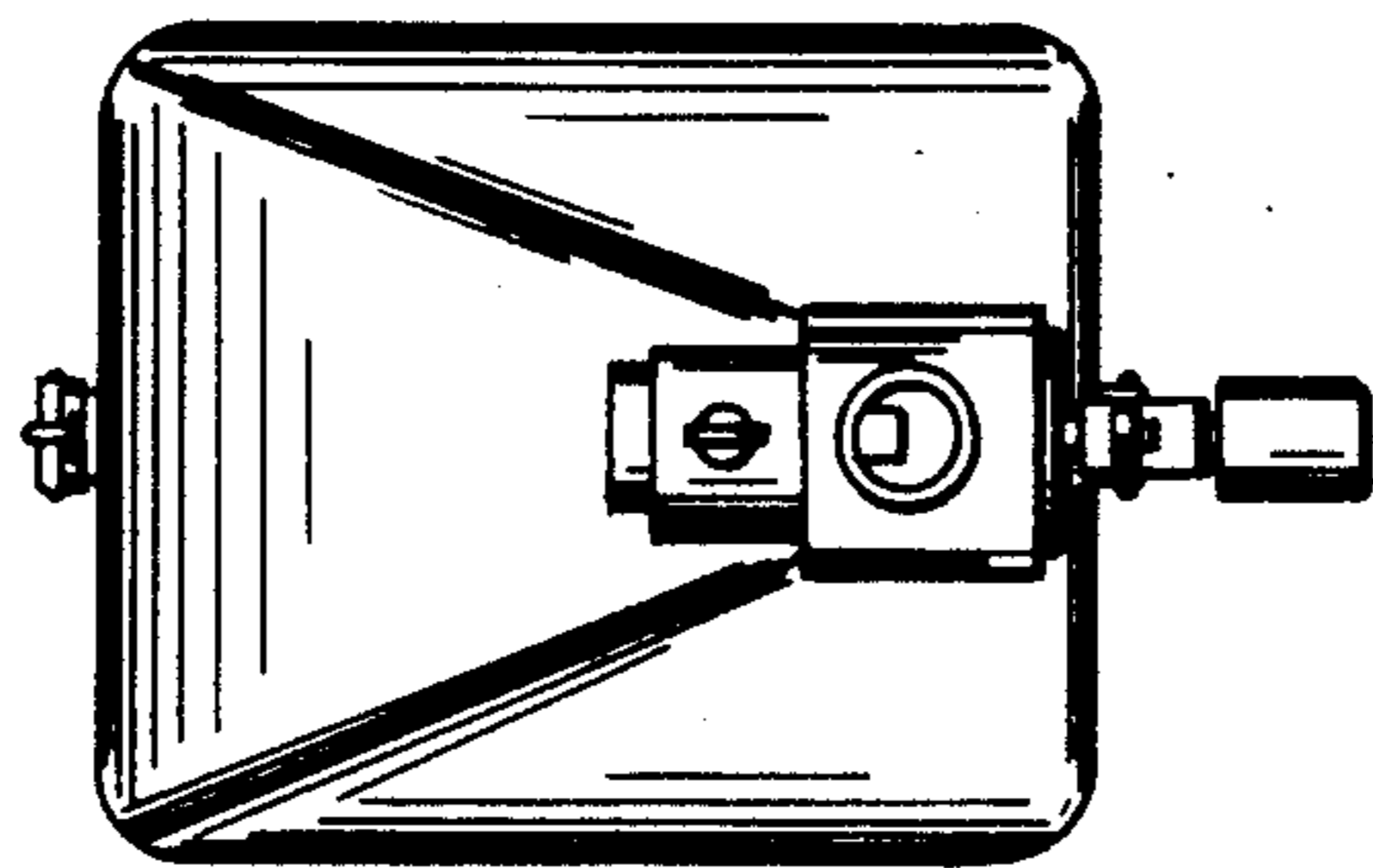

FIG. 5