

[54] MAILBOX

[75] Inventors: Alexander M. Cornwell, Jr., St. Louis; Joseph N. Miller, Overland, both of Mo.

[73] Assignee: Jackes-Evans Manufacturing Company, St. Louis, Mo.

[**] Term: 14 Years

[21] Appl. No.: 851,540

[22] Filed: Nov. 14, 1977

[51] Int. Cl. D31-00

[52] U.S. Cl. D99/29

[58] Field of Search D99/29, 33; 232/17, 232/34, 35, 37

[56] References Cited

U.S. PATENT DOCUMENTS

- D. 221,361 8/1971 Parker D99/29
- D. 249,970 10/1978 Wetzel D99/29

OTHER PUBLICATIONS

1975 Sears Fall & Winter Catalog, p. 875, Rural Mailbox [2], top left side of page.

Primary Examiner—James M. Gandy
Attorney, Agent, or Firm—Kirkland & Ellis

[57] CLAIM

The ornamental design for a mailbox, substantially as shown and described.

DESCRIPTION

FIG. 1 is a perspective view of a mailbox illustrating our new design;

FIG. 2 is a front elevational view thereof;

FIG. 3 is a left side elevational view thereof;

FIG. 4 is a right side elevational view thereof;

FIG. 5 is a top plan view thereof;

FIG. 6 is a rear elevational view thereof;

FIG. 7 is a bottom plan view thereof;

FIG. 8 is a perspective view thereof showing the flag of the mailbox in the raised position.

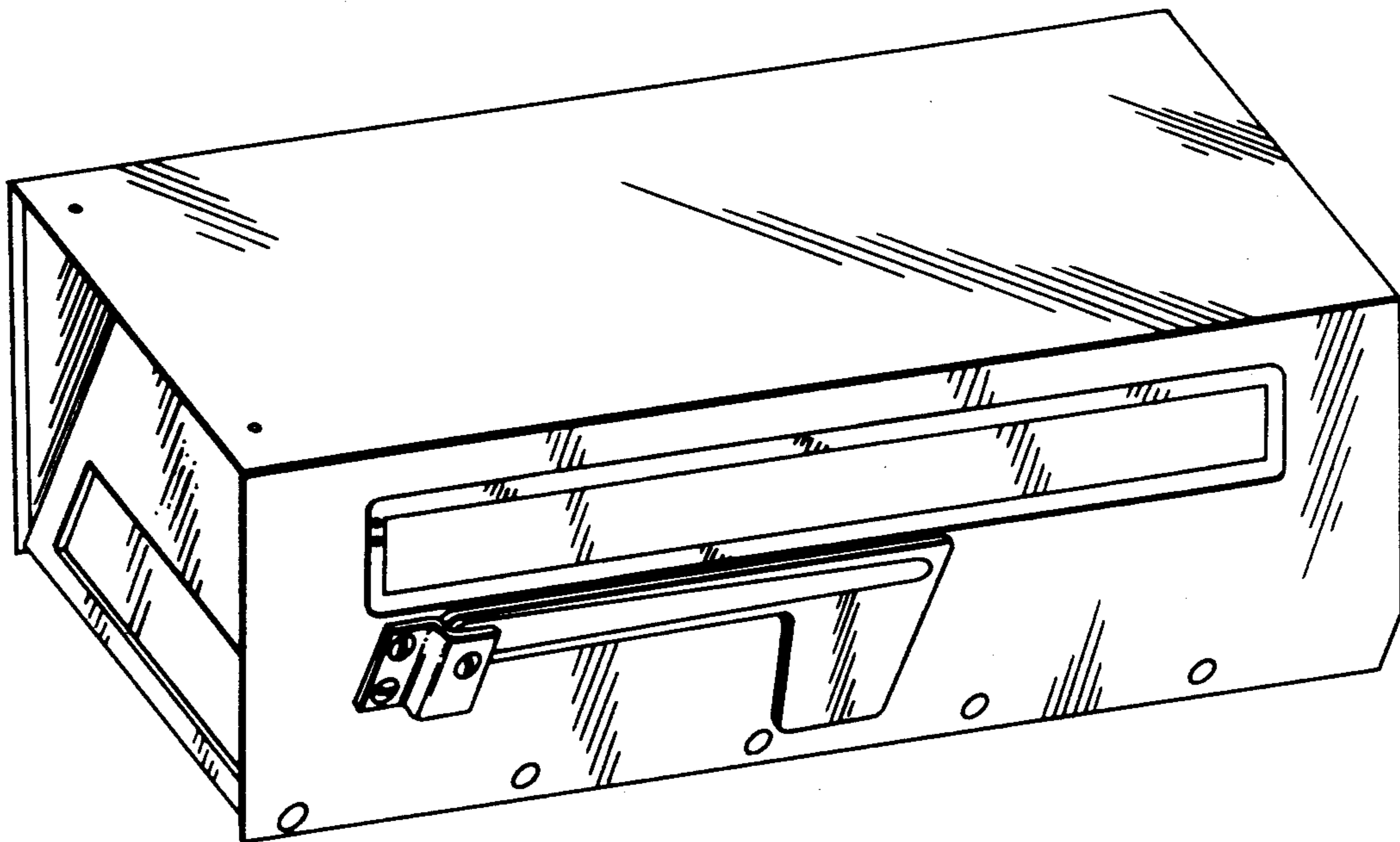

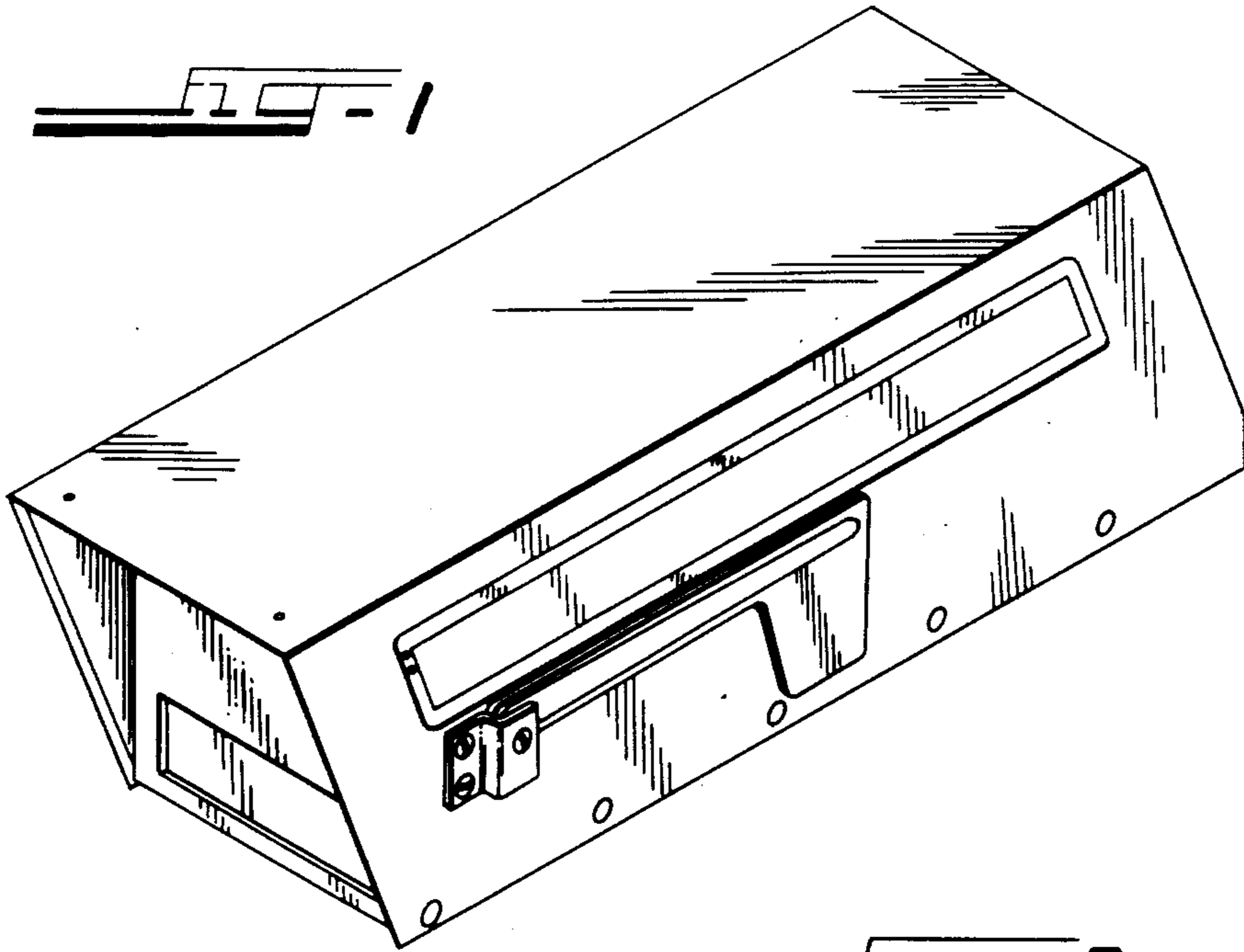

FIG-2

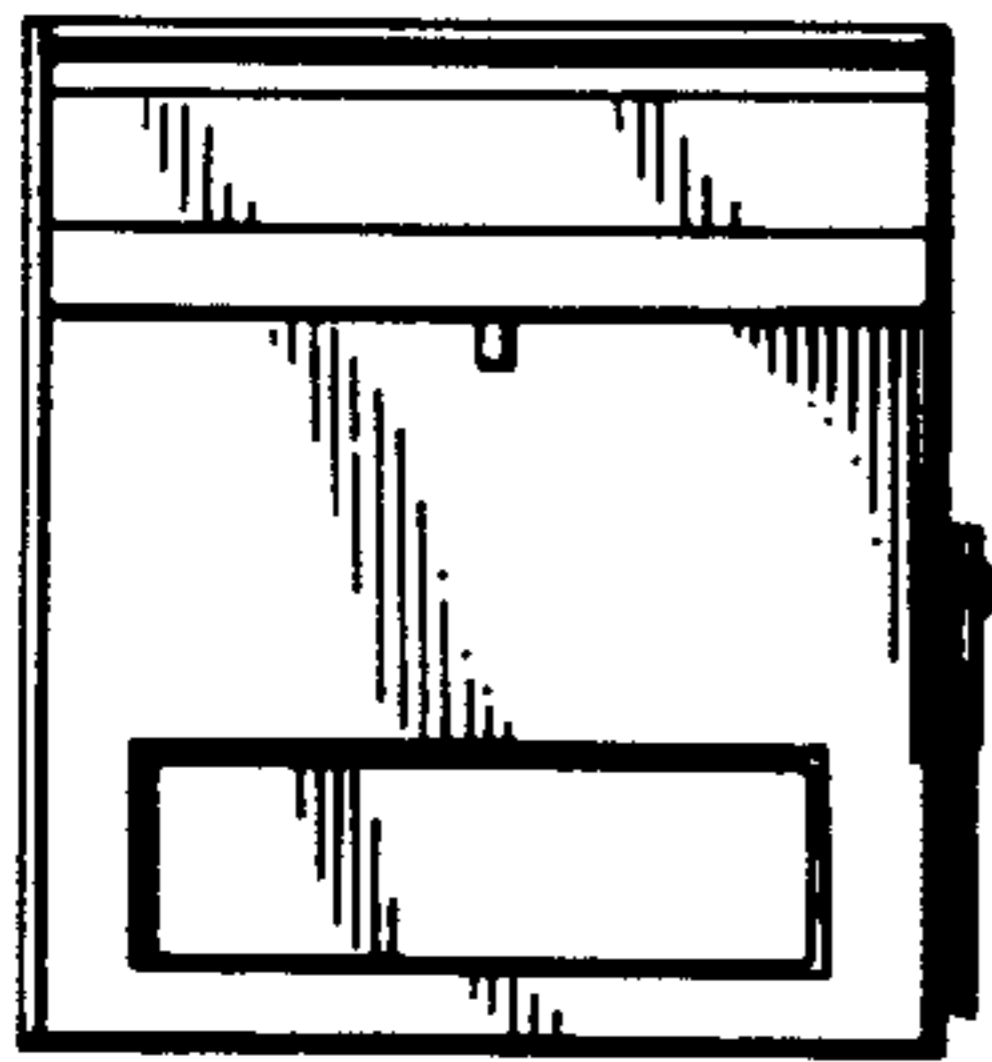

FIG-3

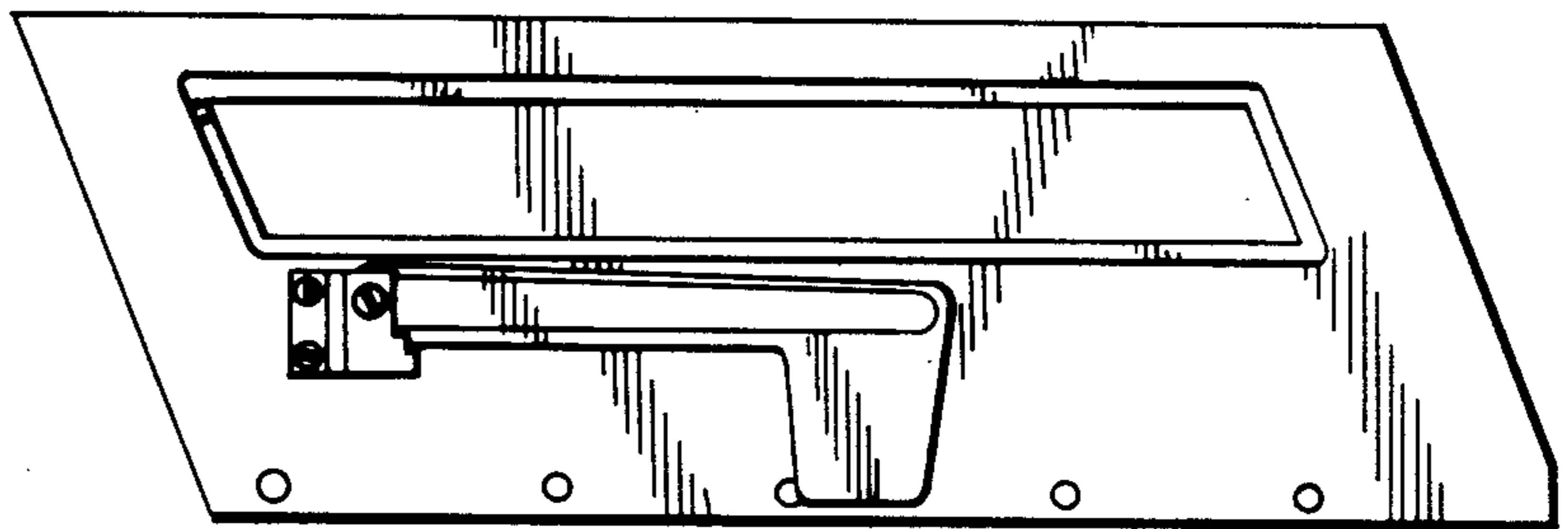

FIG-6

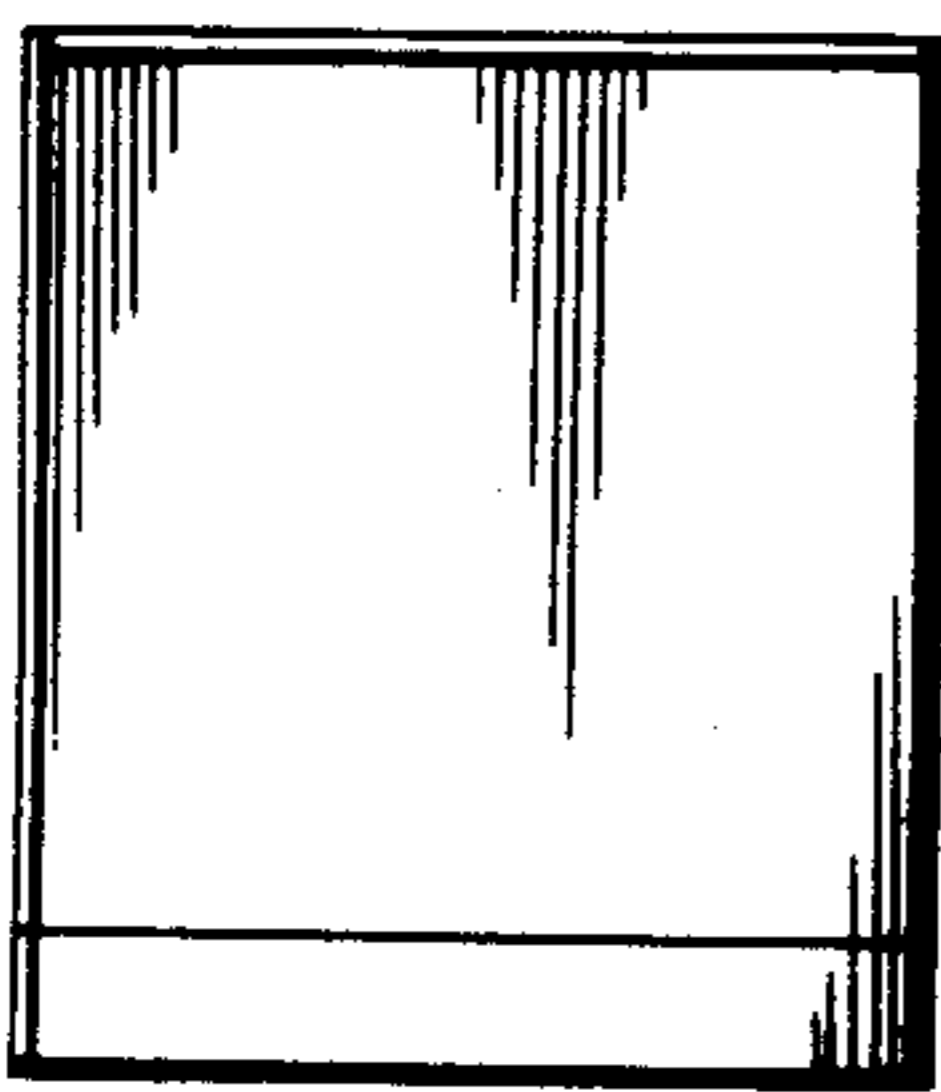

FIG-4

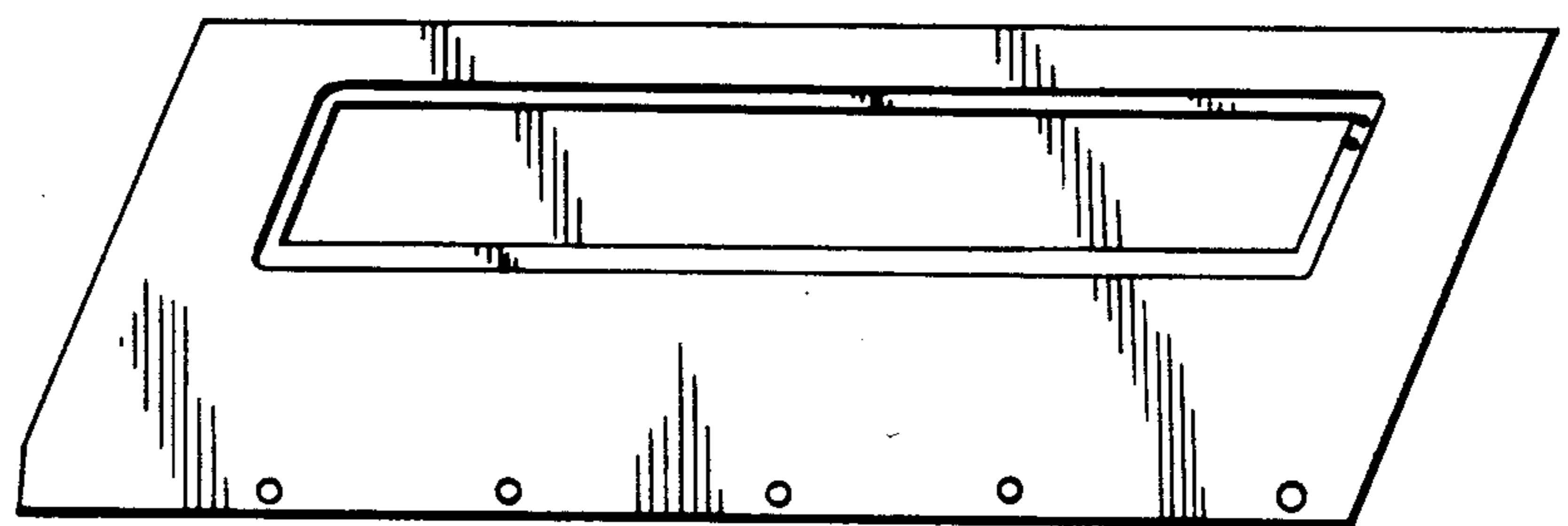

FIG. 5

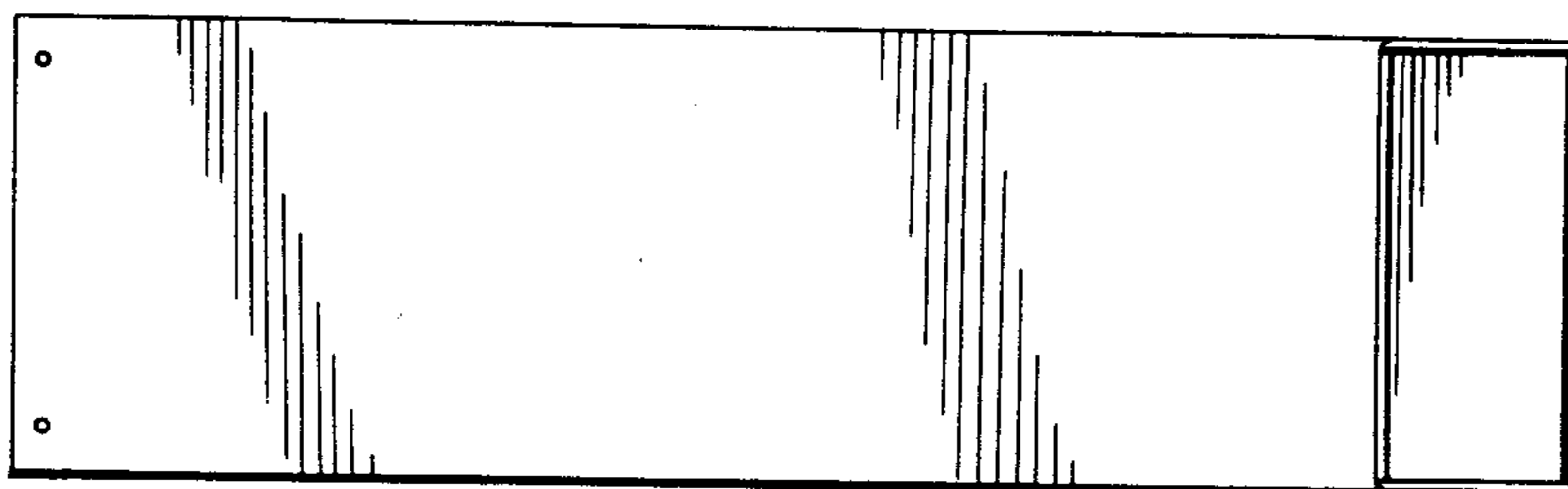

FIG. 7

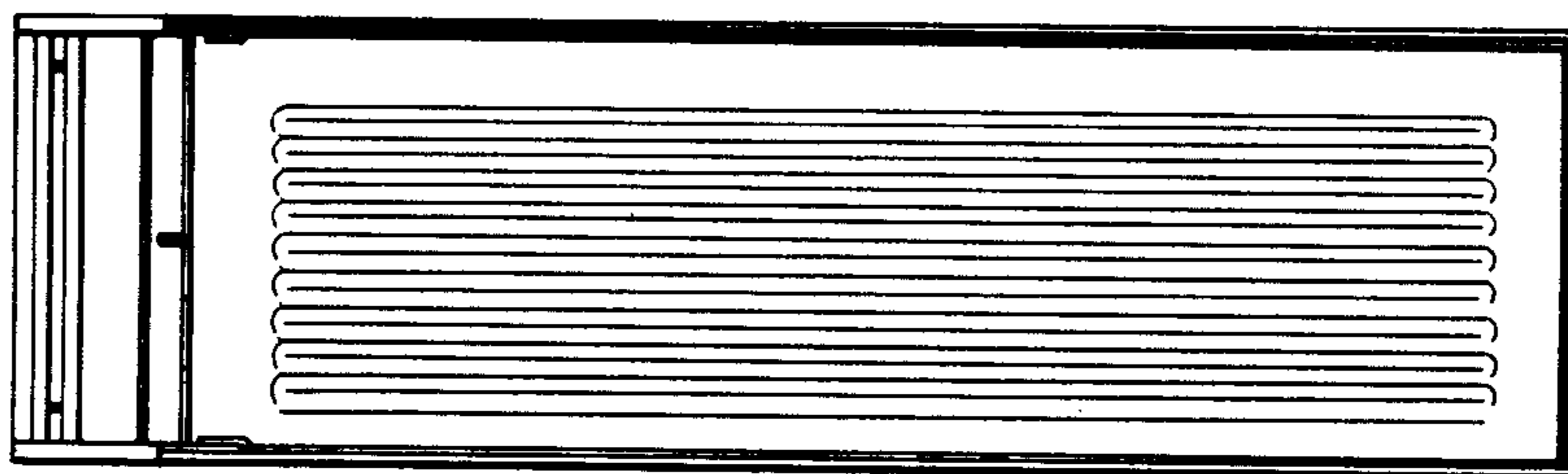

FIG. 8

