

[54] BLOOD GAS SYRINGE STOPPER

[75] Inventor: Russell G. Raitto, Fitzwilliam, N.H.

[73] Assignee: Concord Laboratories, Keene, N.H.

[*] Notice: The portion of the term of this patent subsequent to Aug. 8, 1992, has been disclaimed.

[**] Term: 14 Years

[21] Appl. No.: 896,328

[22] Filed: Apr. 14, 1978

Related U.S. Application Data

[63] Continuation-in-part of Ser. No. 701,609, Jul. 6, 1976, Pat. No. D. 248,873.

[51] Int. Cl. D24-99

[52] U.S. Cl. D24/99; D24/21; D9/285

[58] Field of Search D24/99, 21; 215/353, 215/355, 305; 128/2 F, DIG. 5; D9/254, 267, 284, 287, 285

[56] References Cited

U.S. PATENT DOCUMENTS

D. 248,873	8/1978	Raitto	D24/99
3,005,564	10/1961	Weichselbaum	215/353
3,254,785	6/1966	Lovell	215/305
3,473,685	10/1969	Karlan	215/305 X

OTHER PUBLICATIONS

Fisher Modern Laboratory Appliances, Cat. 65, ©1964, p. 848, item No. 14-127-25, Stopper.

Primary Examiner—Bernard Ansher
Attorney, Agent, or Firm—Sewall P. Bronstein

[57] CLAIM

The ornamental design for a blood gas syringe stopper, substantially as shown and described.

DESCRIPTION

FIG. 1 is a top plan view of a blood gas syringe stopper showing my new design;
FIG. 2 is a side view thereof;
FIG. 3 is a bottom plan view thereof;
FIG. 4 is a front isometric view taken at a reduced scale;
FIG. 5 is a rear isometric view thereof;
FIG. 6 is a sectional view at line 6-6 of FIG. 1; and
FIG. 7 is a sectional view at line 7-7 of FIG. 2.

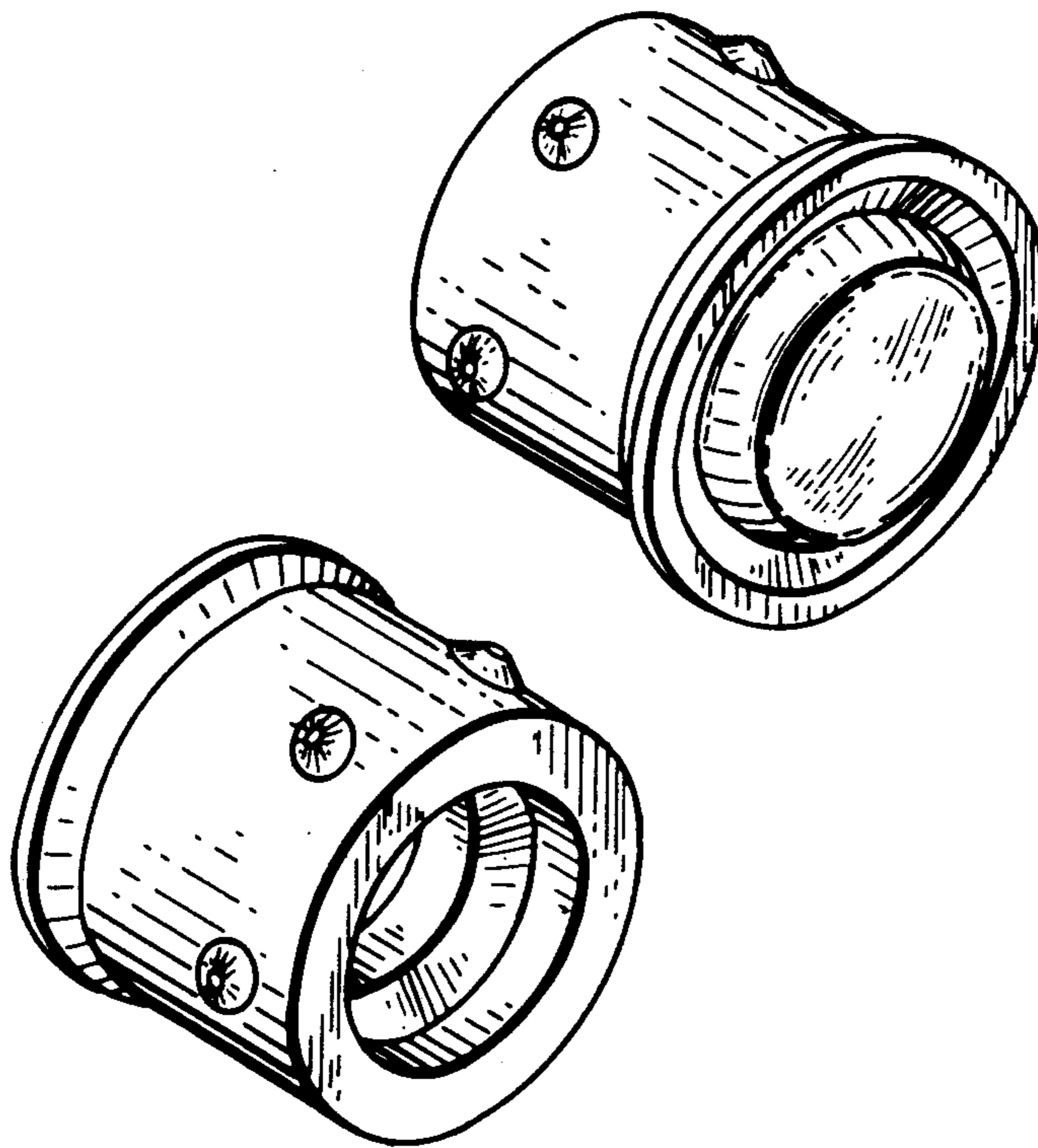

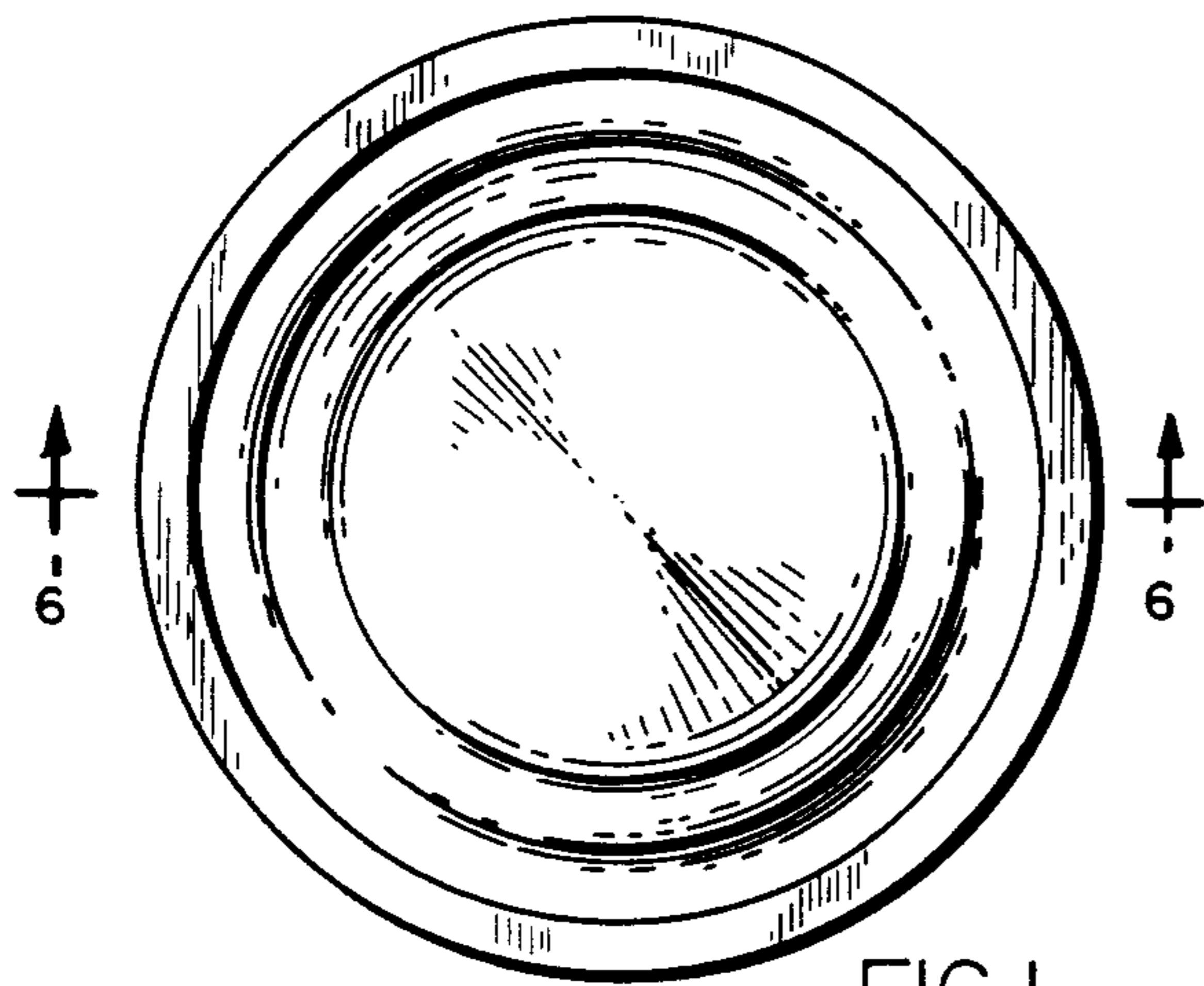

FIG. 1

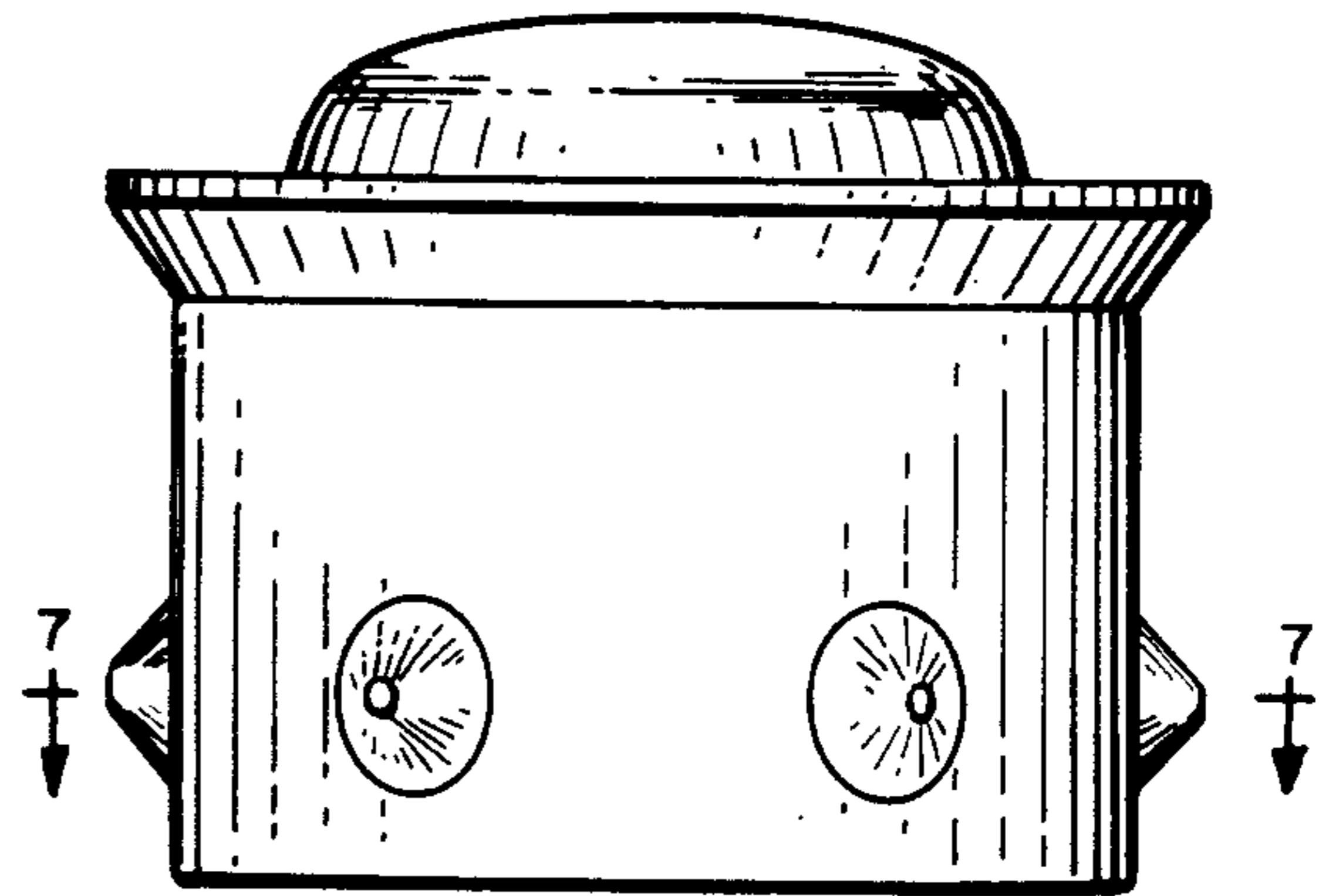

FIG. 2

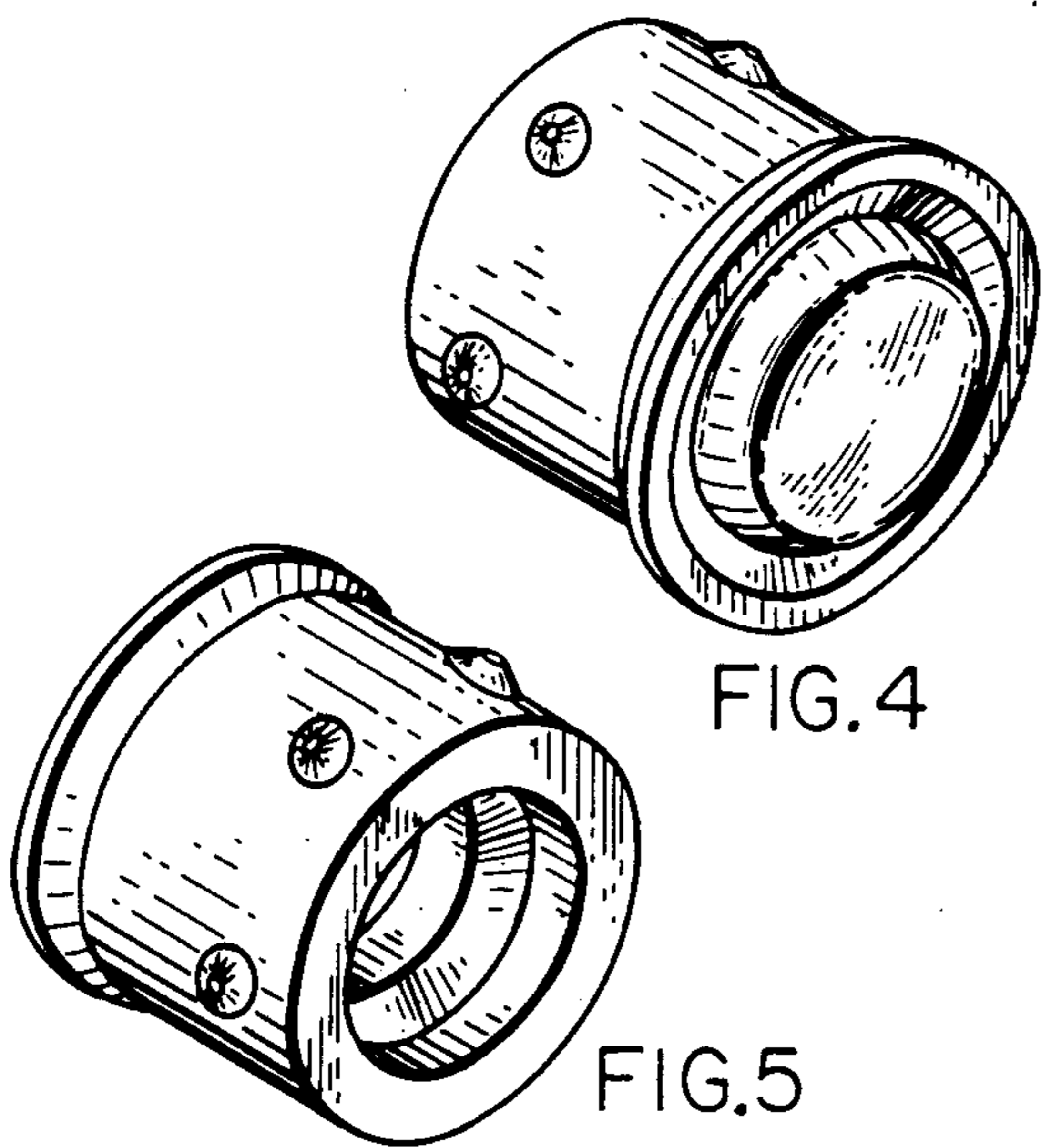

FIG. 4

FIG. 5

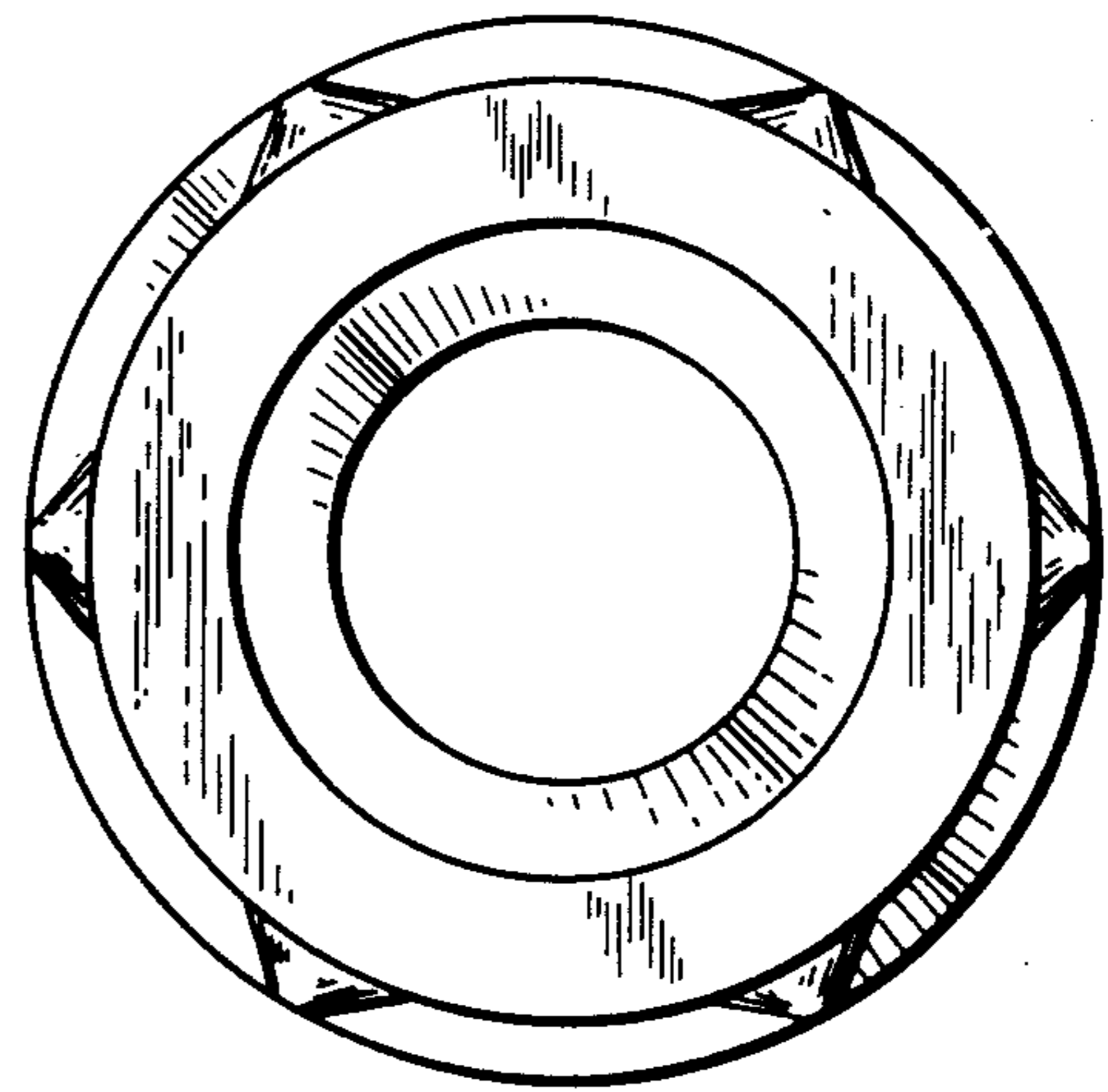

FIG. 3

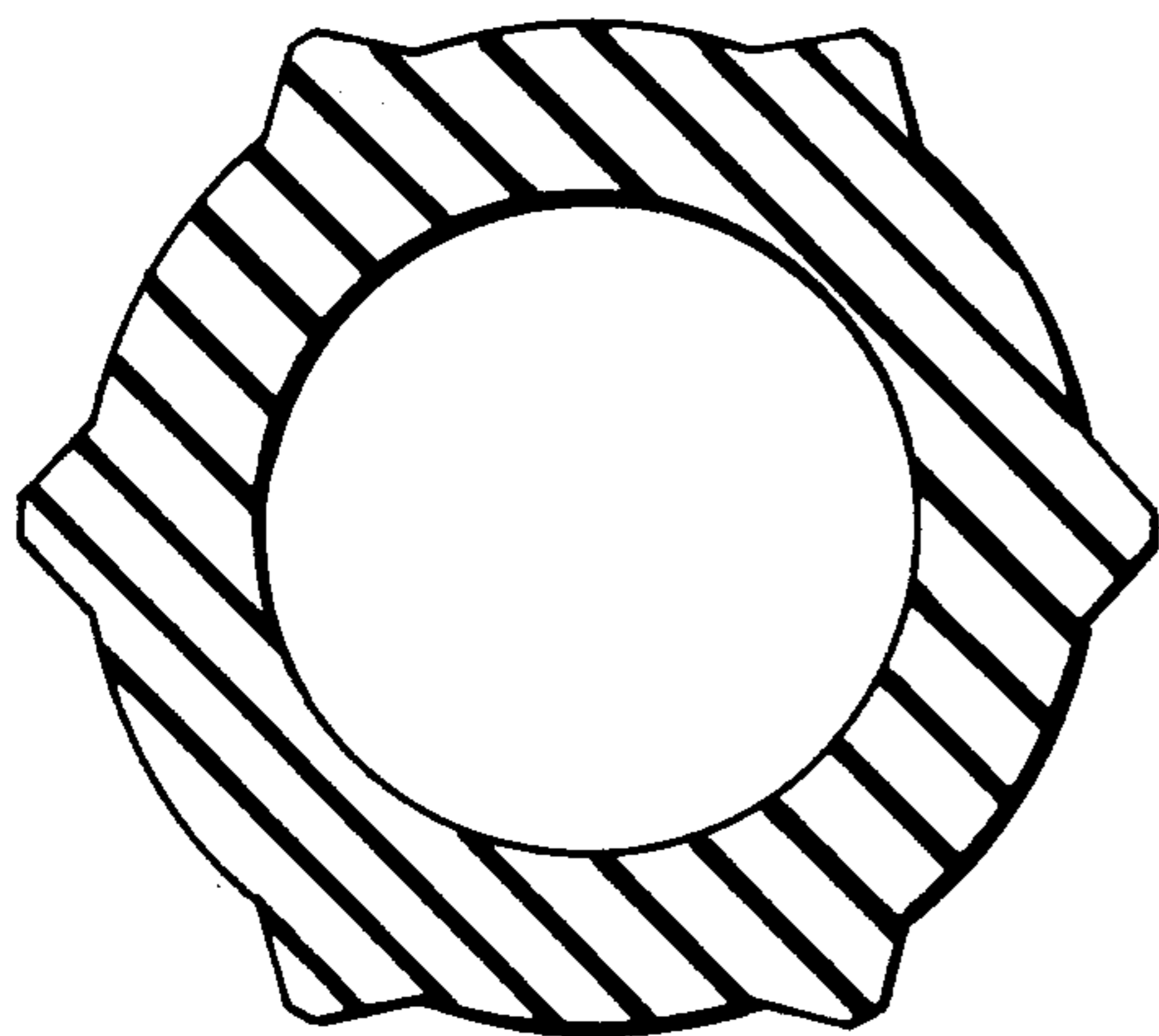

FIG. 7

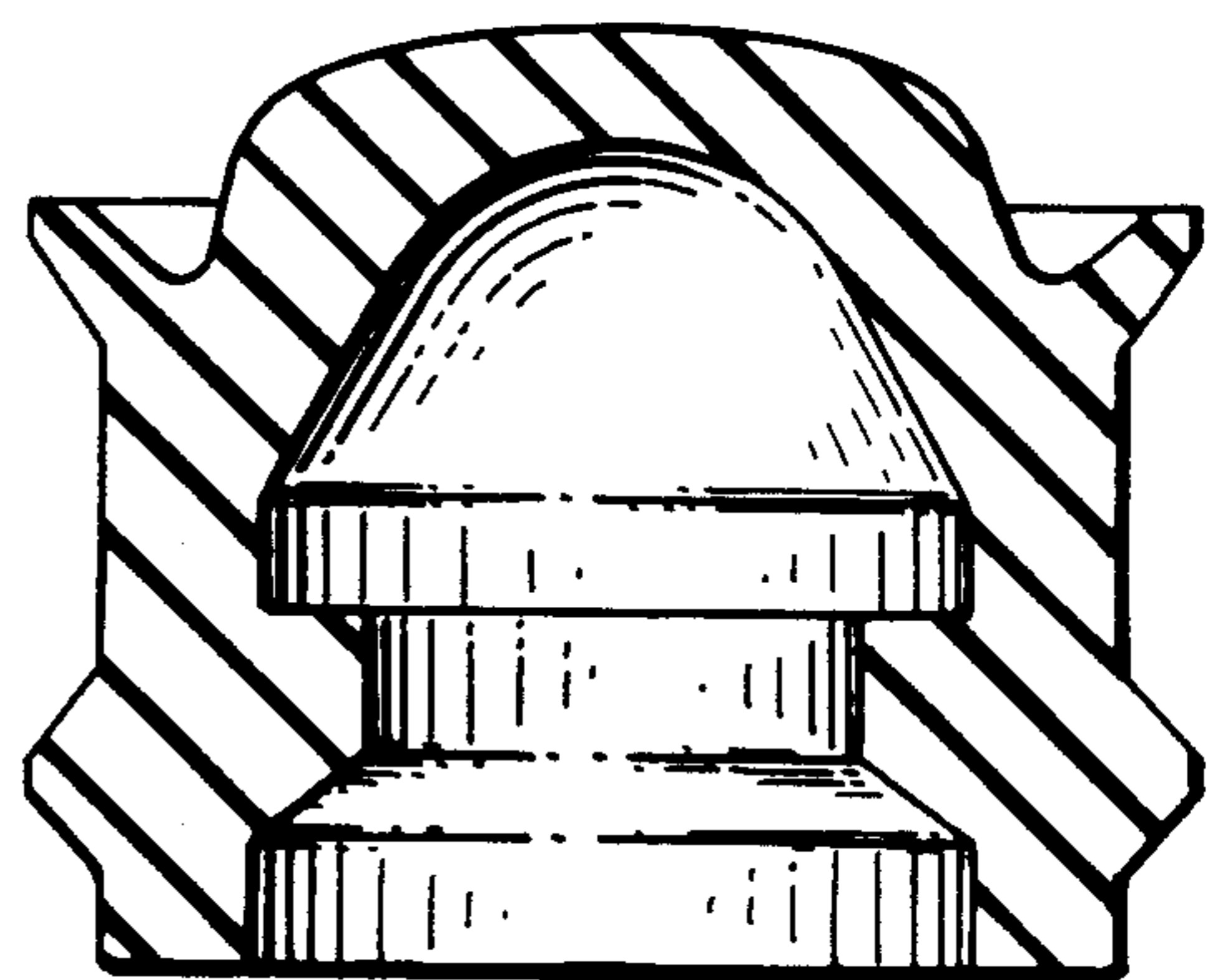

FIG. 6