

[54] COMBINED FLOWERPOT TRAY, AND WATERING RESERVOIRS

[75] Inventor: Carlo M. Sgroi, Oceanside, N.Y.

[73] Assignee: Pax Technology Ltd., Hicksville, N.Y.

[**] Term: 14 Years

[21] Appl. No.: 938,037

[22] Filed: Aug. 30, 1978

[51] Int. Cl. D11-02

[52] U.S. Cl. D11/153; D11/143

[58] Field of Search D11/143-149, D11/151-156, 164; 47/14, 16, 41 R, 41 SS, 33, 55, 59, 61, 66-69, 71, 72, 83, 85-87, 79, 81

[56] References Cited

U.S. PATENT DOCUMENTS

954,440	4/1910	Klemm	47/79
2,802,305	8/1957	MacNaughton	D11/153
3,962,824	6/1976	Poston	47/81

FOREIGN PATENT DOCUMENTS

2634037	2/1978	Fed. Rep. of Germany	47/79
1200203	12/1959	France	47/79

Primary Examiner—Wallace R. Burke

Assistant Examiner—B. J. Bullock
Attorney, Agent, or Firm—Jerome Bauer

[57] CLAIM

The ornamental design for combined flowerpot, tray and watering reservoirs, substantially as shown and described.

DESCRIPTION

FIG. 1 is a top view of a combined flowerpot, tray and watering reservoirs showing my design;
 FIG. 2 is a front view of FIG. 1;
 FIG. 3 is a side view of FIG. 1;
 FIG. 4 is a bottom view of FIG. 1;
 FIG. 5 is an exploded perspective view thereof;
 FIG. 6 is a front perspective view of the flowerpot and tray in assembled relation;
 FIG. 7 is a side perspective view of FIG. 6;
 FIG. 8 is an elevational view of the inside of one of the watering reservoirs;
 FIG. 9 is a top view of FIG. 8;
 FIG. 10 is a side view of FIG. 8;
 FIG. 11 is a bottom view of FIG. 8; and
 FIG. 12 is perspective view of the flowerpot, tray and one of the watering reservoirs in assembled relation.
 In FIGS. 5 through 12, the individual elements of the combined flowerpot, tray and watering reservoirs therefor are shown separately and in combination for illustrative purposes only.

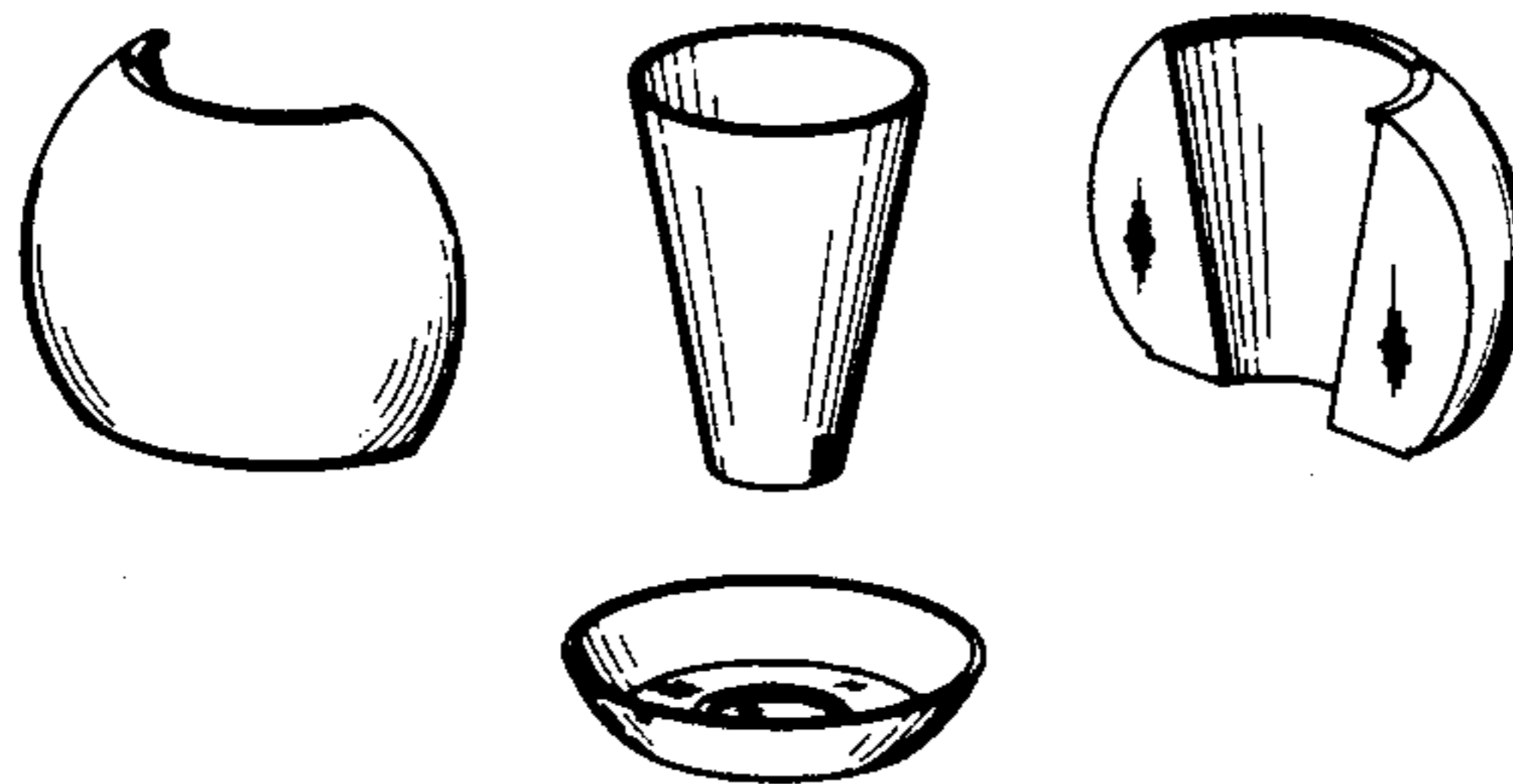
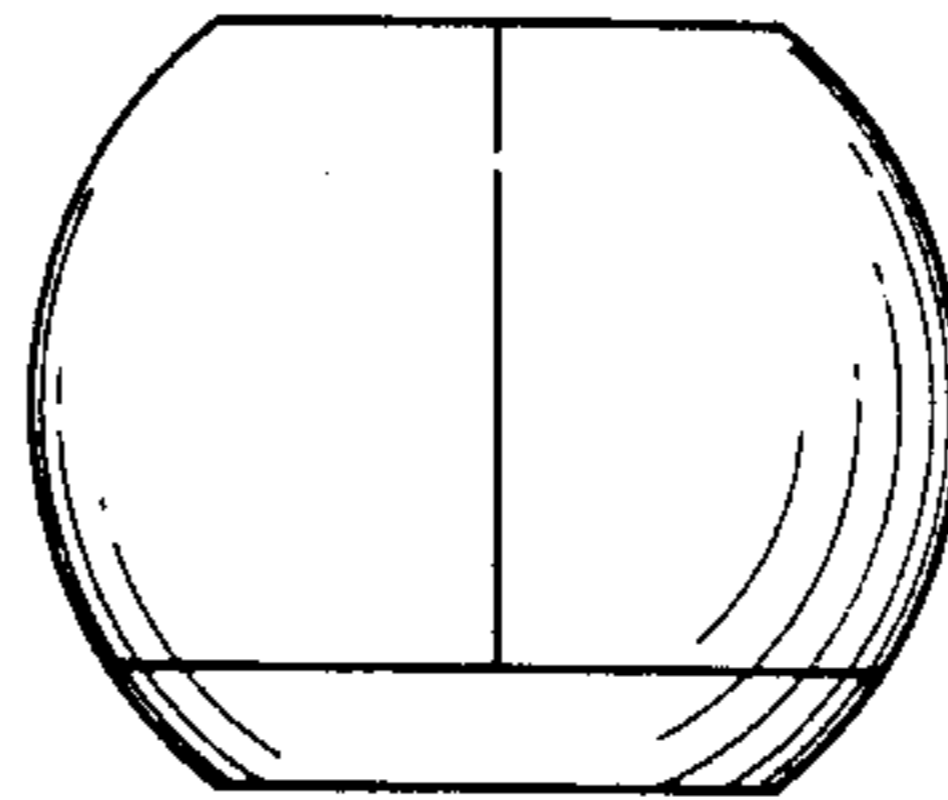

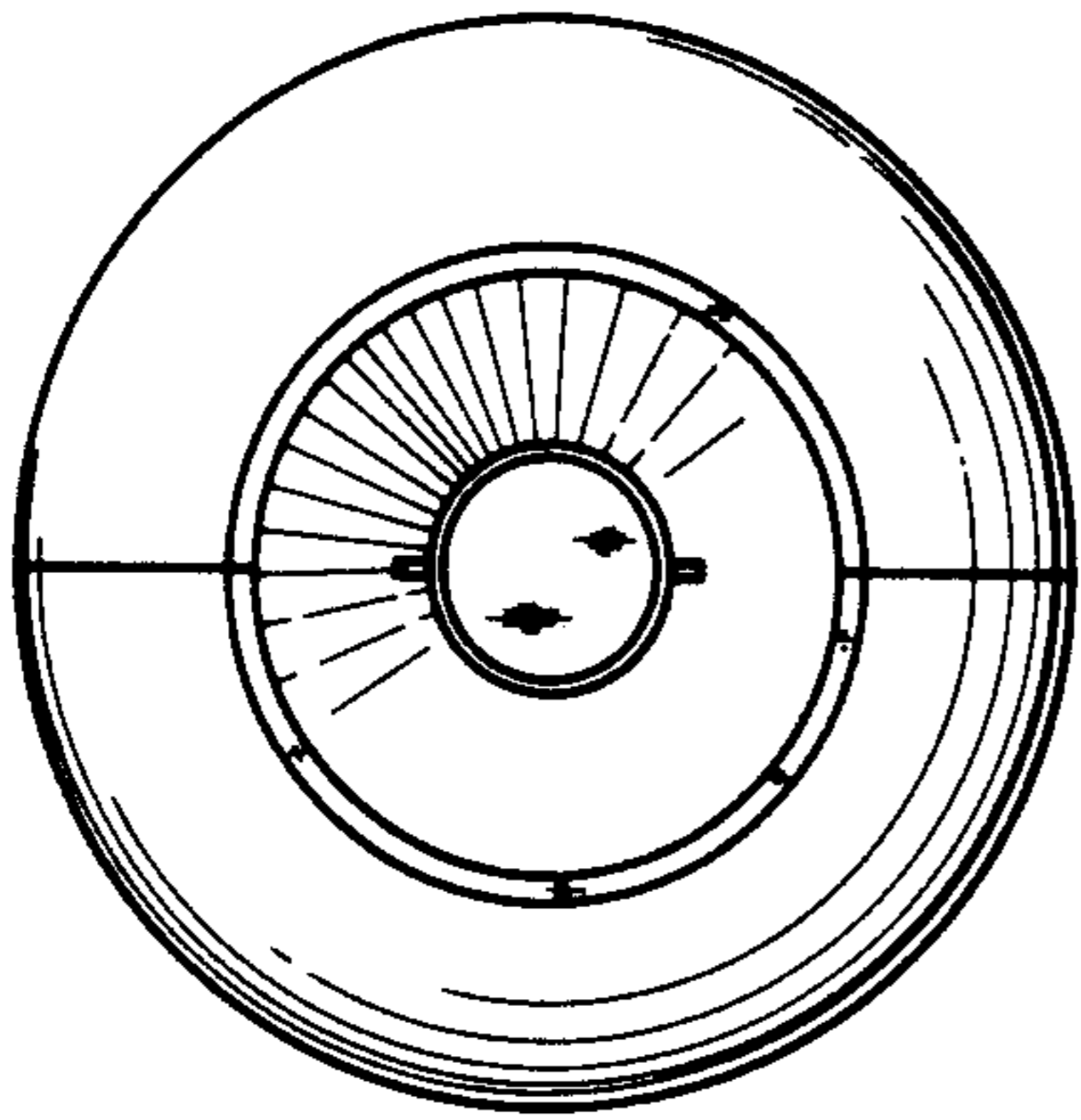

FIG. 1

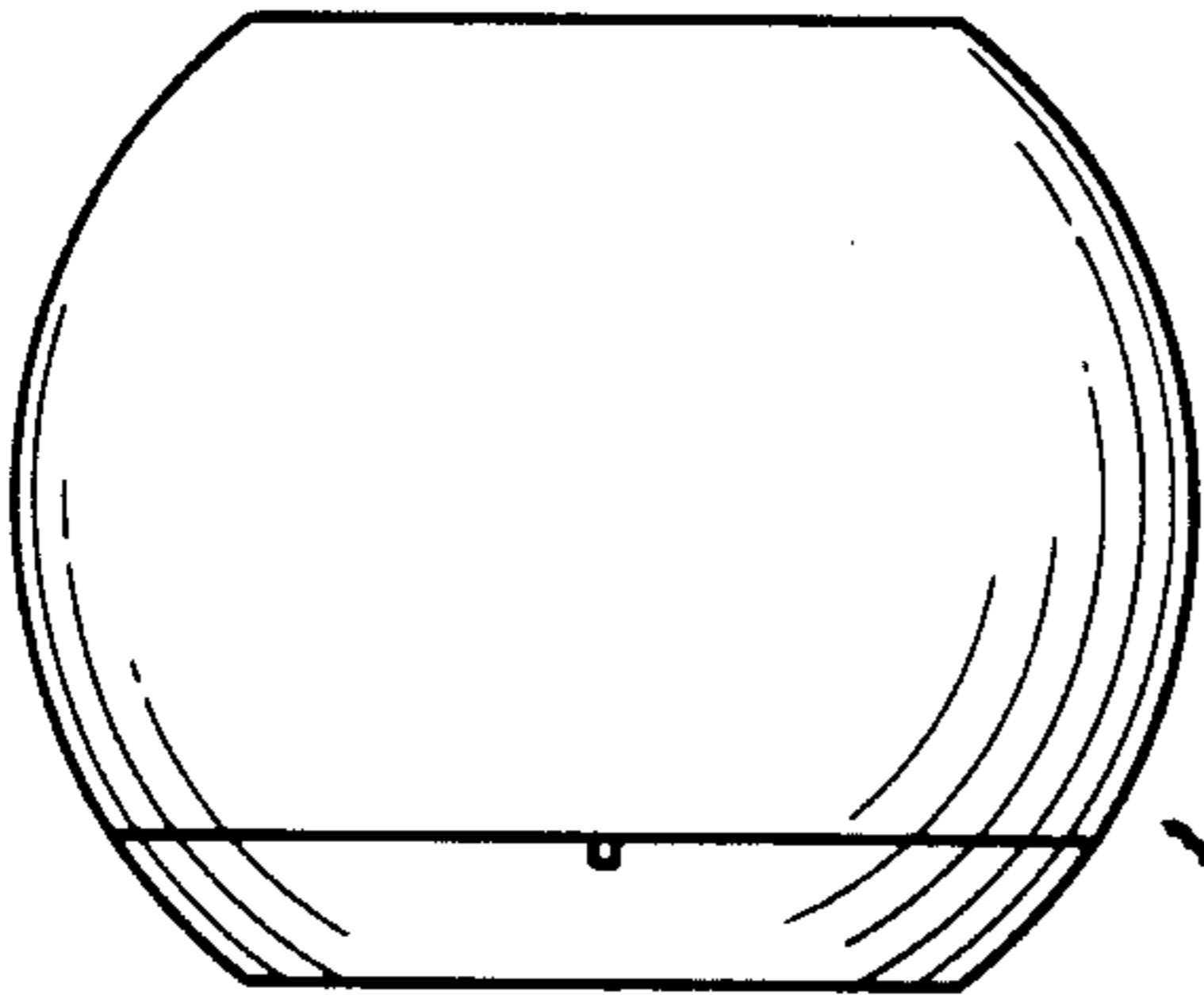

FIG. 2

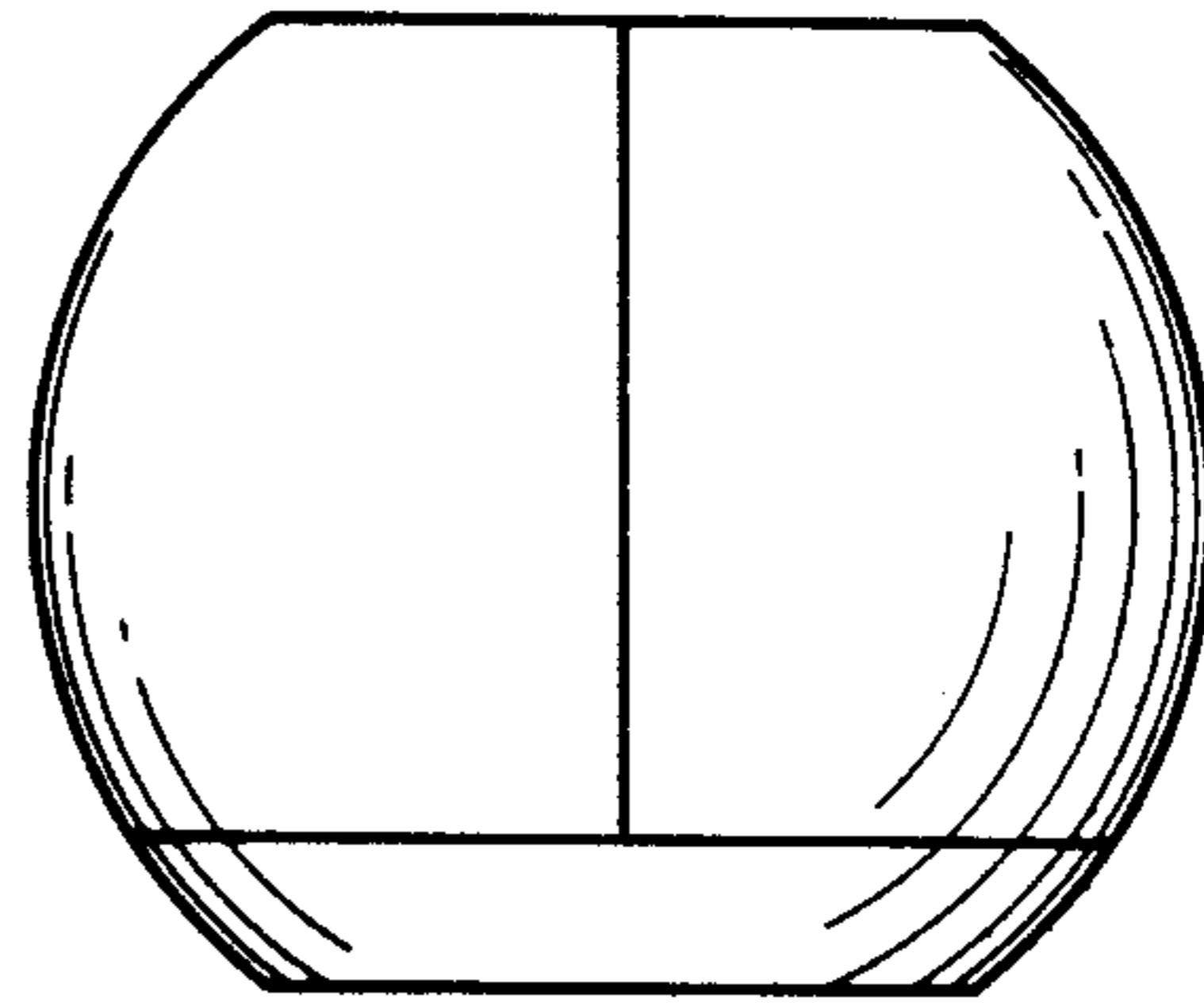

FIG. 3

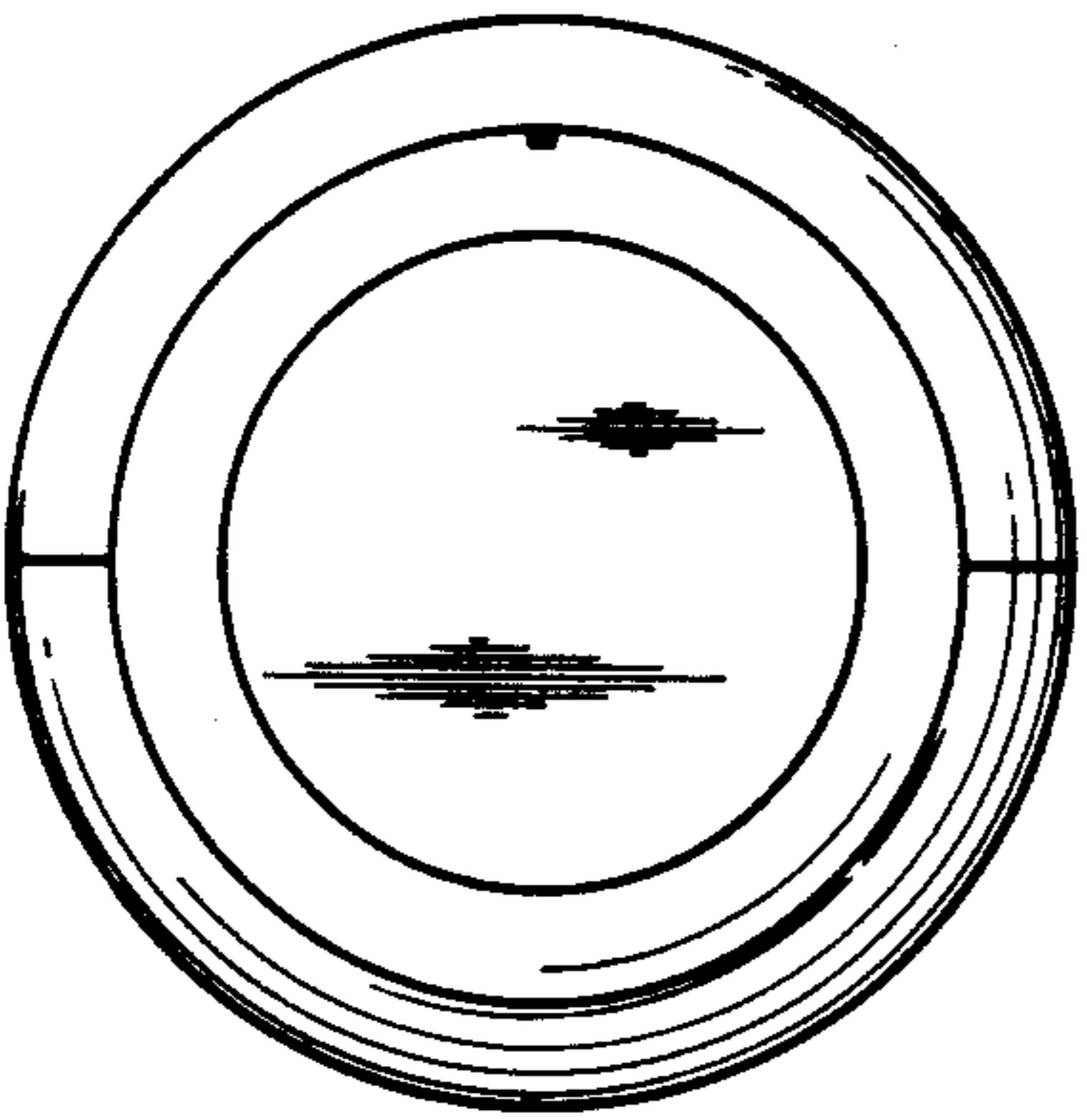

FIG. 4

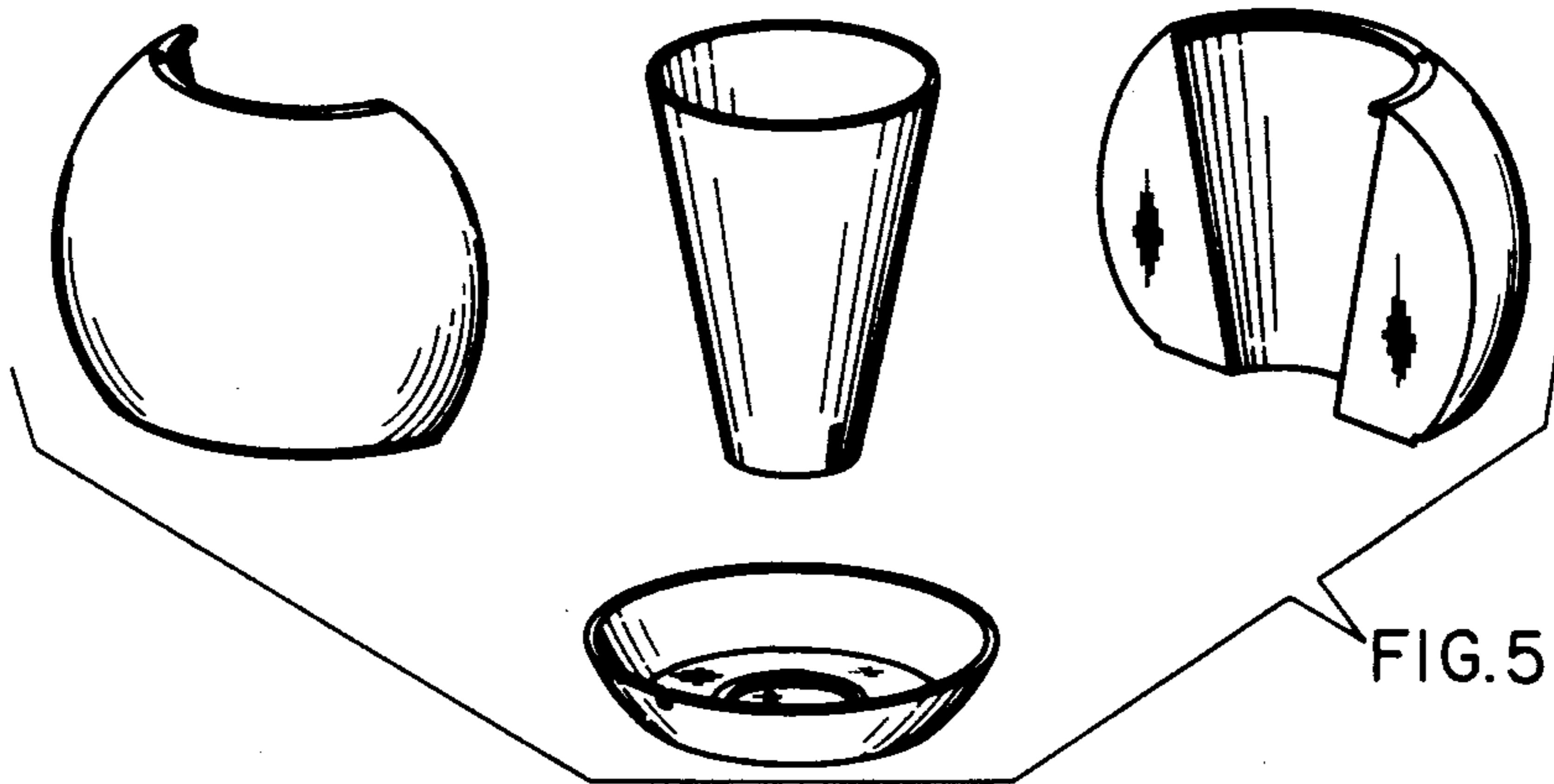

FIG. 5

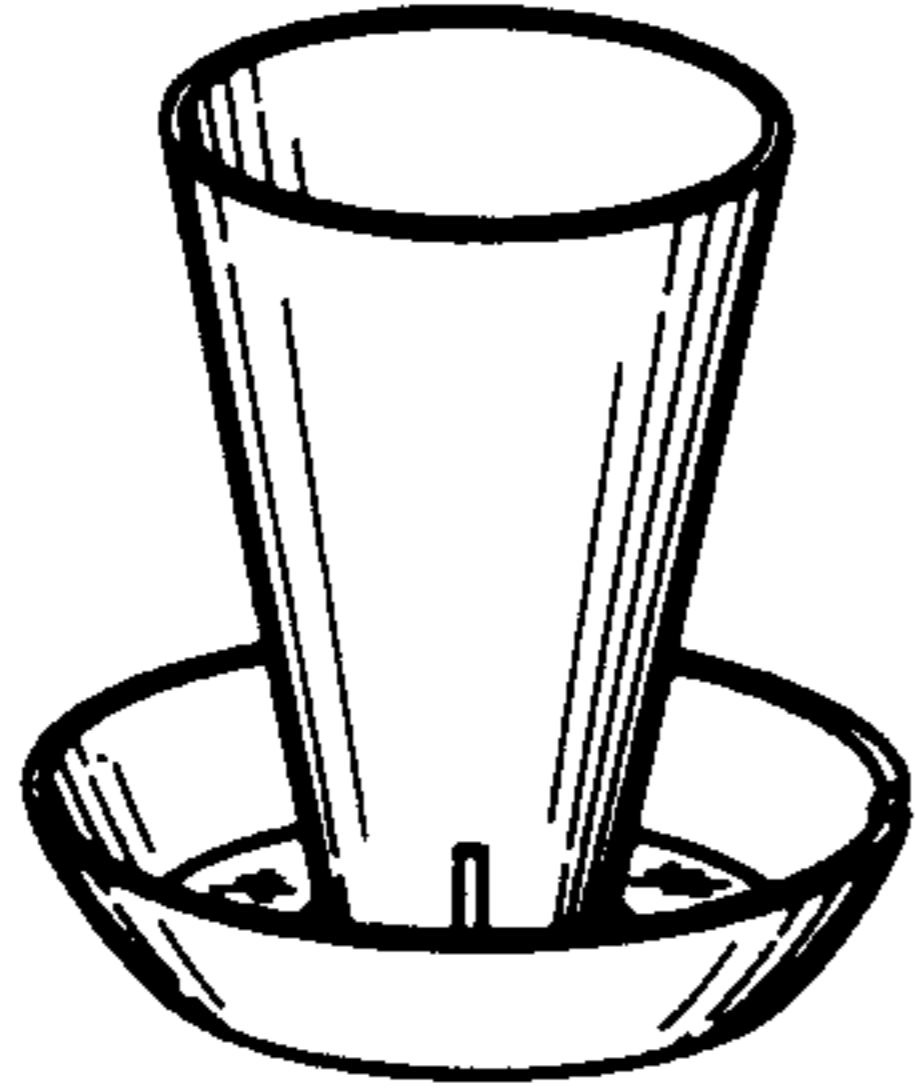

FIG. 6

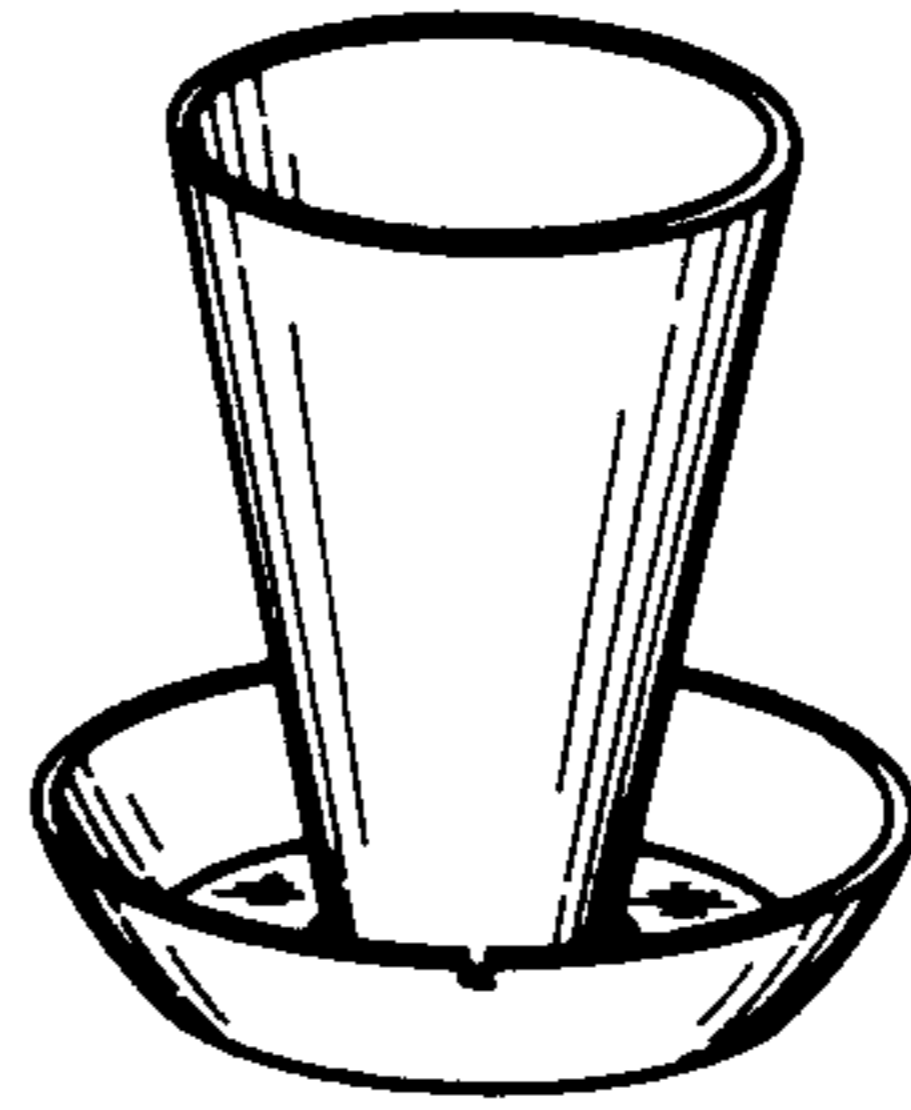

FIG. 7

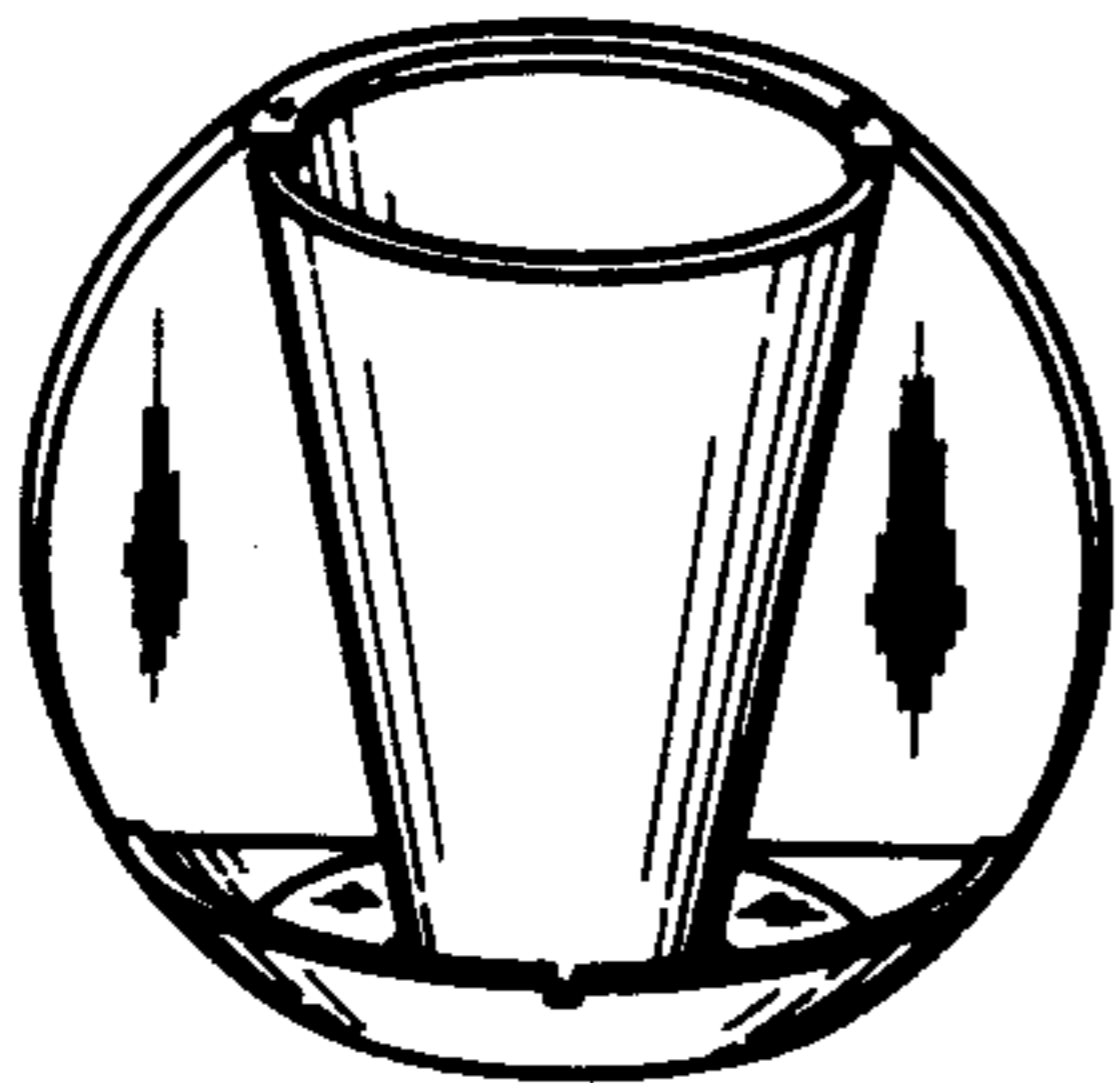

FIG. 12

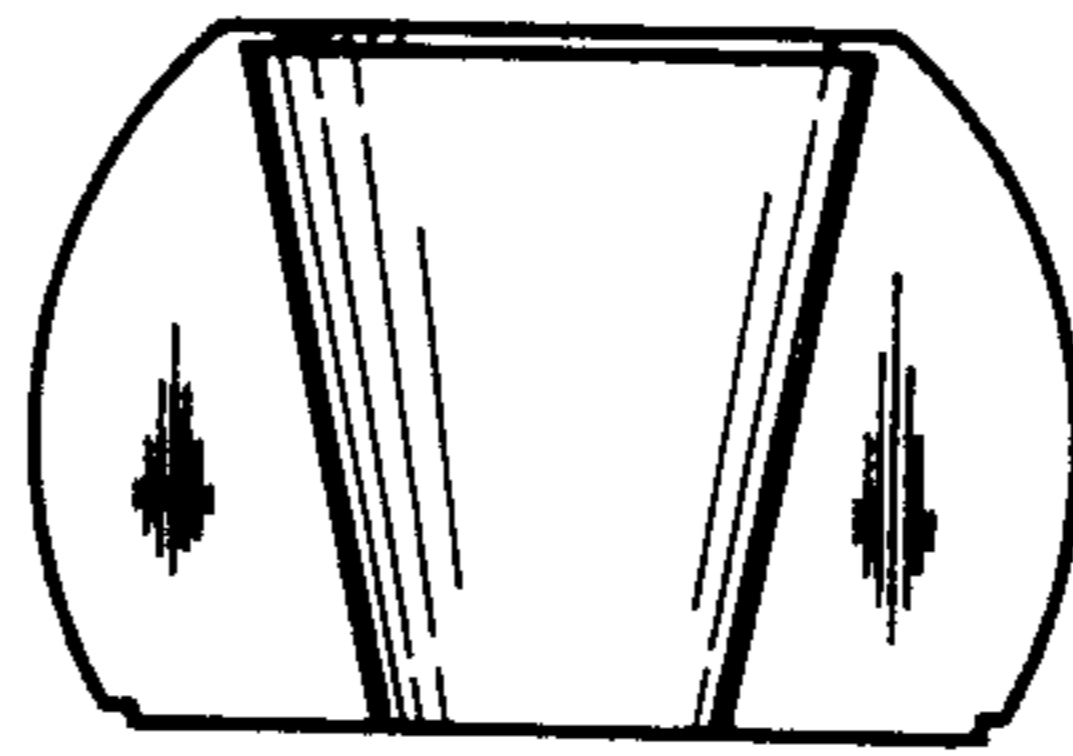

FIG. 8

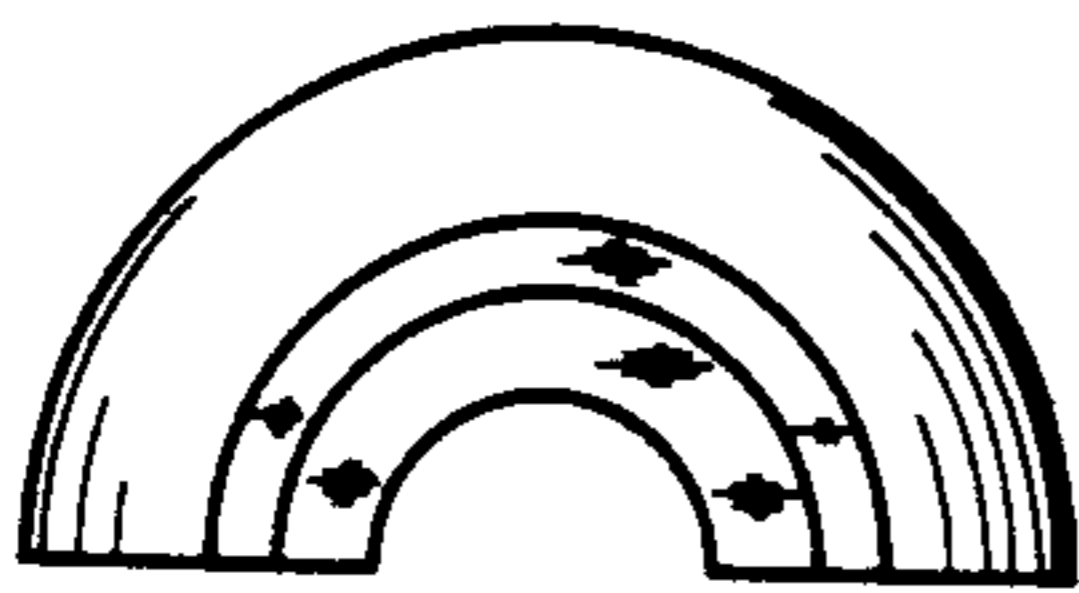

FIG. 9

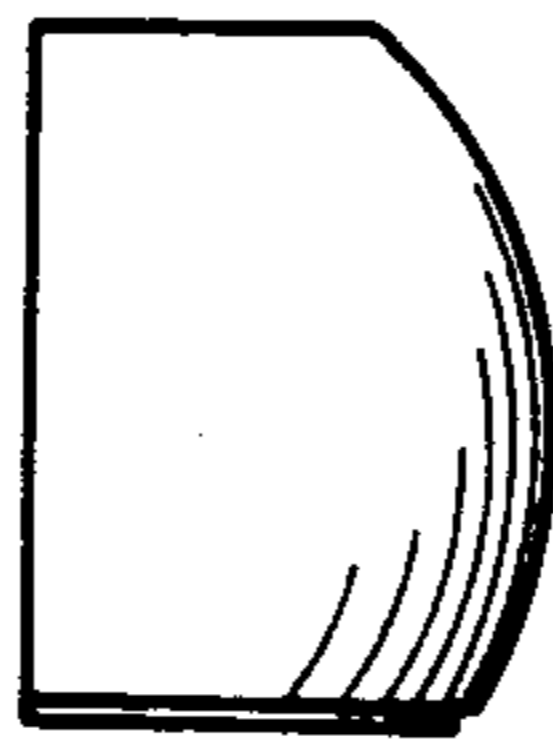

FIG. 10

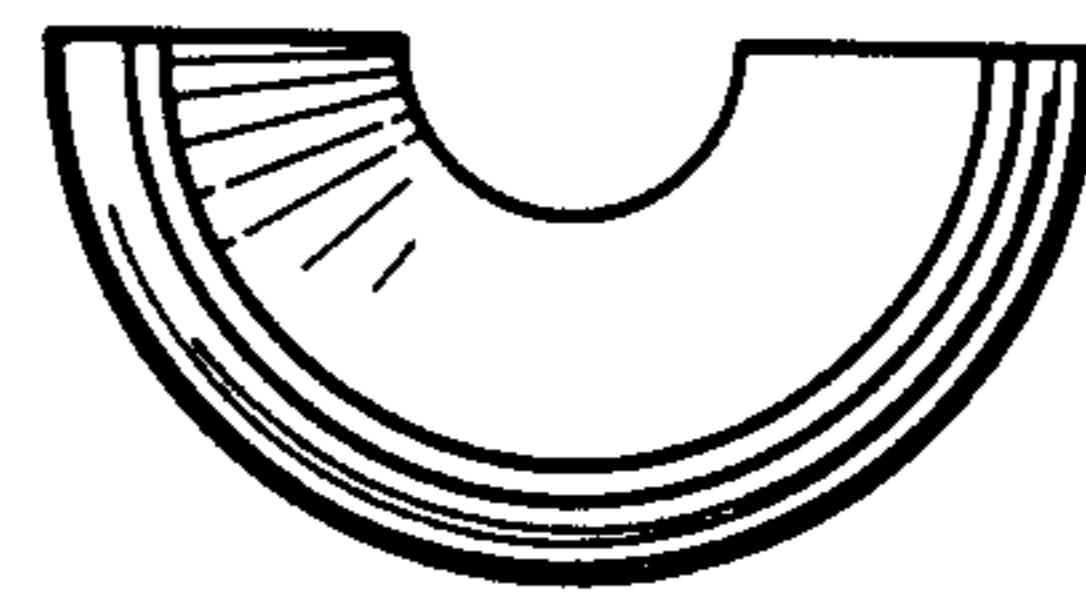

FIG. 11

UNITED STATES PATENT AND TRADEMARK OFFICE
CERTIFICATE OF CORRECTION

PATENT NO. : Des. 254,127
DATED : February 5, 1980
INVENTOR(S) : CARLO M. SGROI

It is certified that error appears in the above-identified patent and that said Letters Patent are hereby corrected as shown below:

In the title, insert a comma after "flowerpot"

In Fig. 1, line 2, after "reservoirs" insert "--therefor"

In Fig. 5, delete "thereof" and insert "--Fig. 1--"

Signed and Sealed this

Sixth Day of May 1980

[SEAL]

Attest:

SIDNEY A. DIAMOND

Attesting Officer

Commissioner of Patents and Trademarks