

[54] GOLF CLUB HEAD

[76] Inventor: Myron Hulyk, 20037 Edmunton, St. Clair Shores, Mich. 48080

[**] Term: 14 Years

[21] Appl. No.: 883,691

[22] Filed: Mar. 6, 1978

[51] Int. Cl. D21-02

[52] U.S. Cl. D21/217

[58] Field of Search D21/214-220; 273/167-175

[56] References Cited

U.S. PATENT DOCUMENTS

D. 227,794 7/1973 Sasse D21/218

OTHER PUBLICATIONS

House & Garden, Jun., 1962, p. 46, Golf Club.

Primary Examiner—Melvin B. Feifer

Attorney, Agent, or Firm—Harness, Dickey & Pierce

[57] CLAIM

The ornamental design for a golf club head, as shown.

DESCRIPTION

FIG. 1 is a perspective view of the golf club head embodying the ornamental design;

FIG. 2 is a side elevational view of the golf club head illustrated in FIG. 1;

FIG. 3 is a rear view of the golf club head illustrated in FIG. 1;

FIG. 4 is a front view of the golf club head illustrated in FIG. 1;

FIG. 5 is a top view of the golf club head illustrated in FIG. 1;

FIG. 6 is an elevational view of the back side of the golf club head illustrated in FIG. 1;

FIG. 7 is a sectional view taken along the line VII—VII of FIG. 2;

FIG. 8 is a sectional view view taken along the line VIII—VIII of FIG. 2;

FIG. 9 is a sectional view taken along the line IX—IX of FIG. 2.

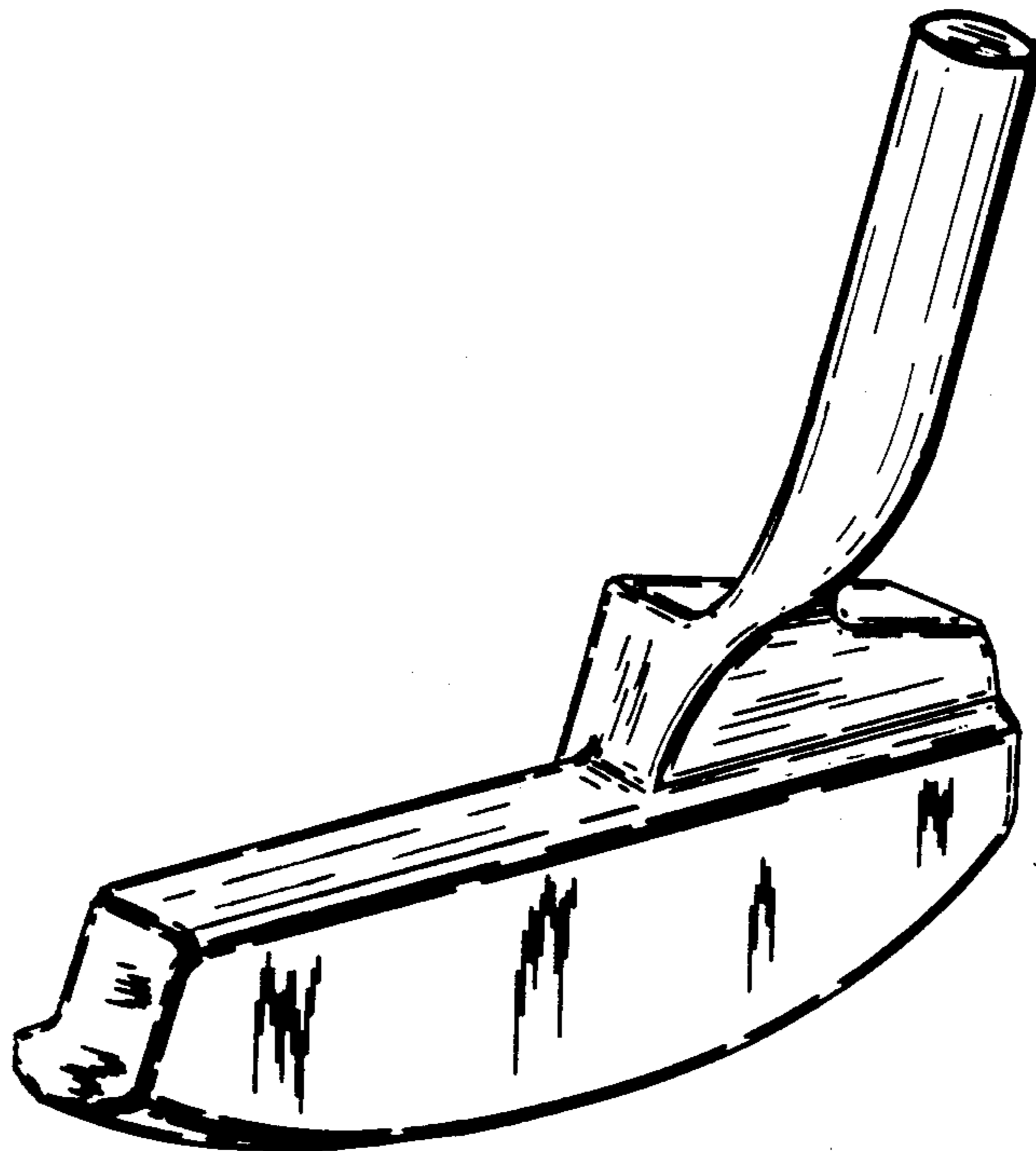

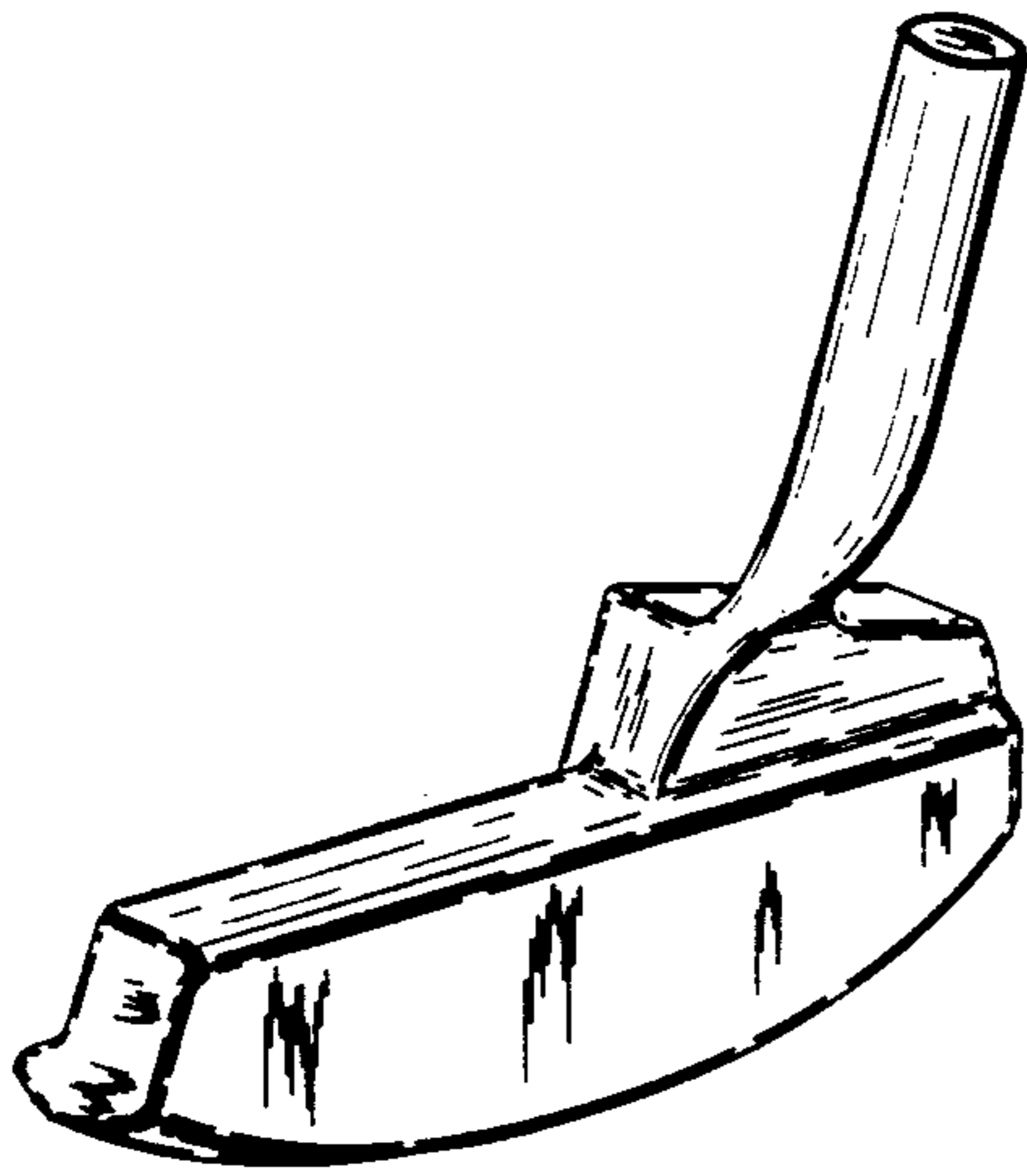

FIG. 1.

FIG. 5.

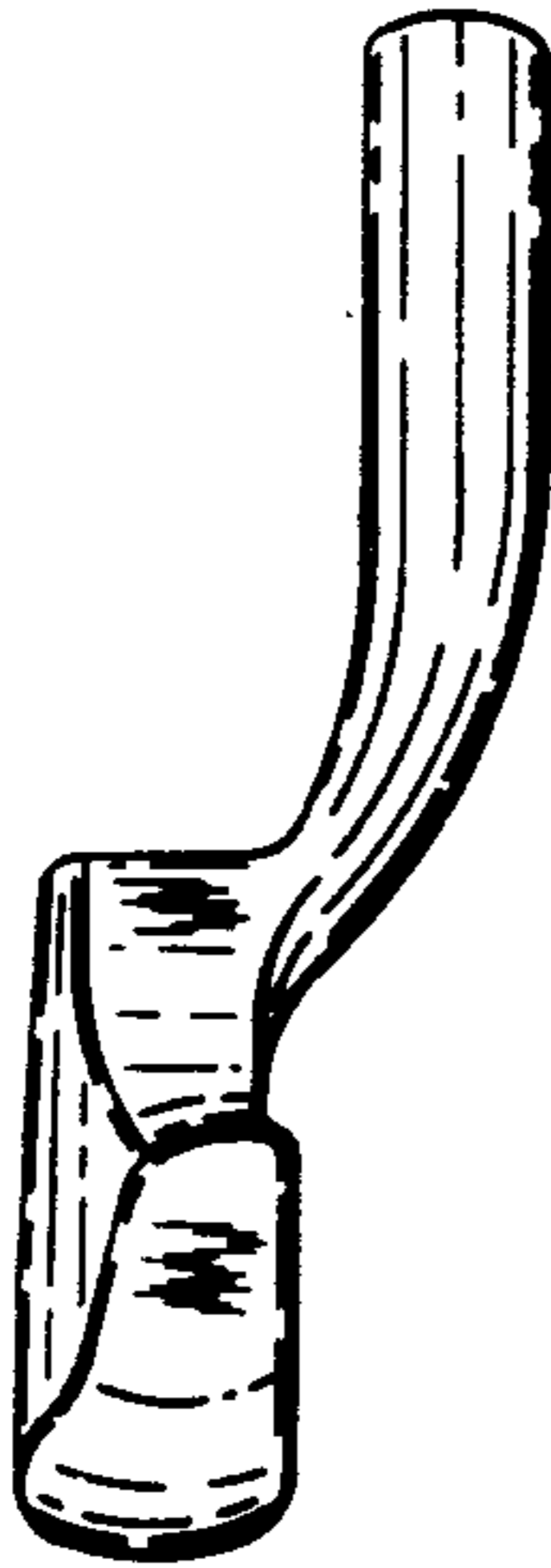
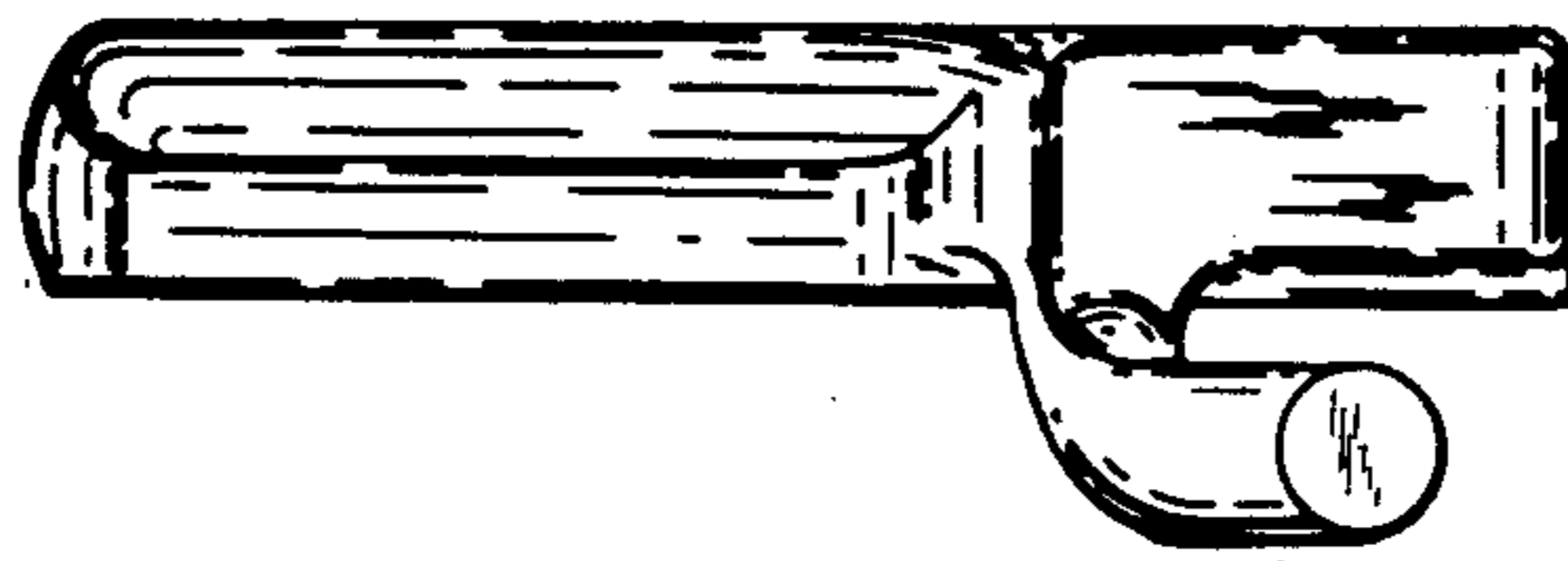

FIG. 4.

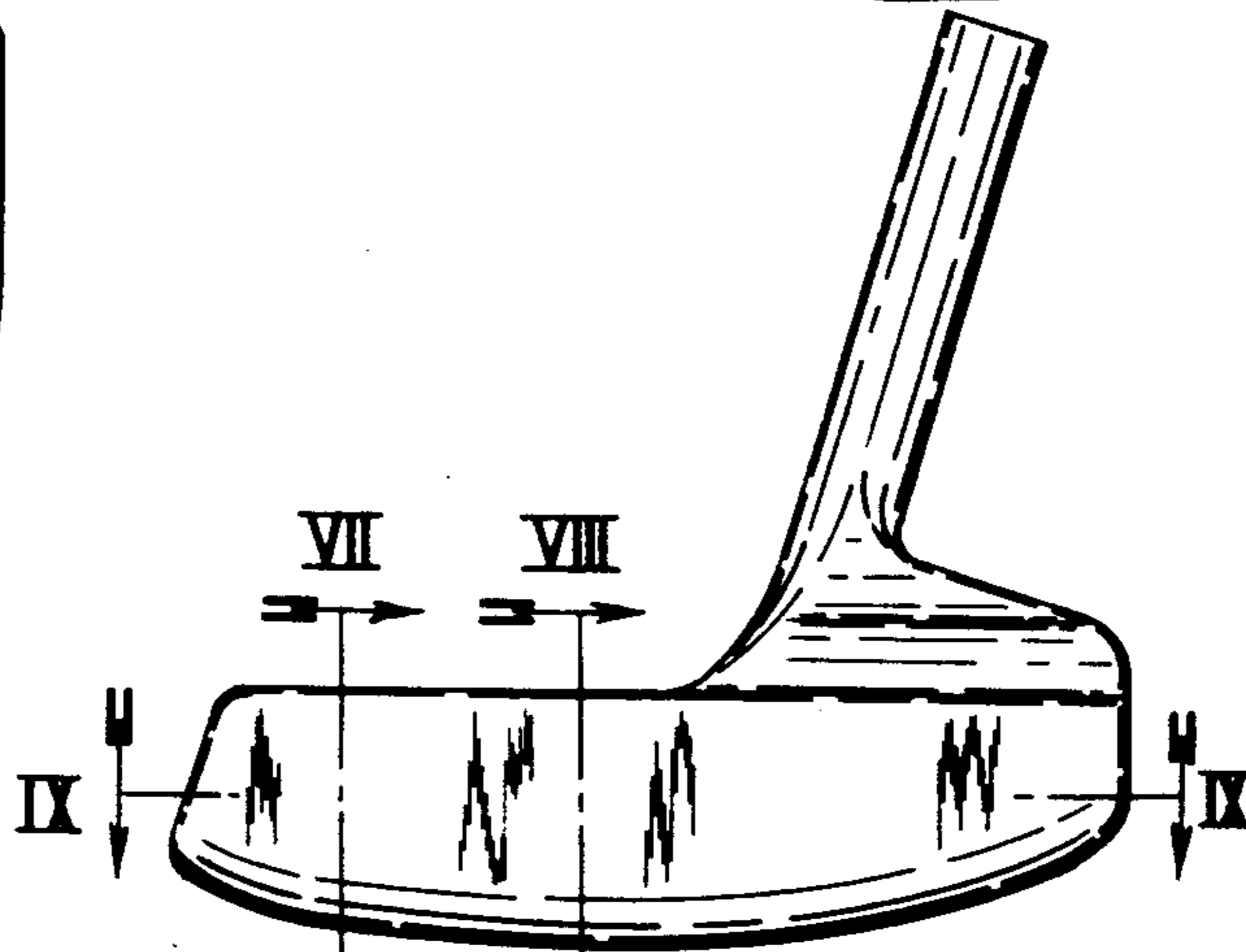

FIG. 2.

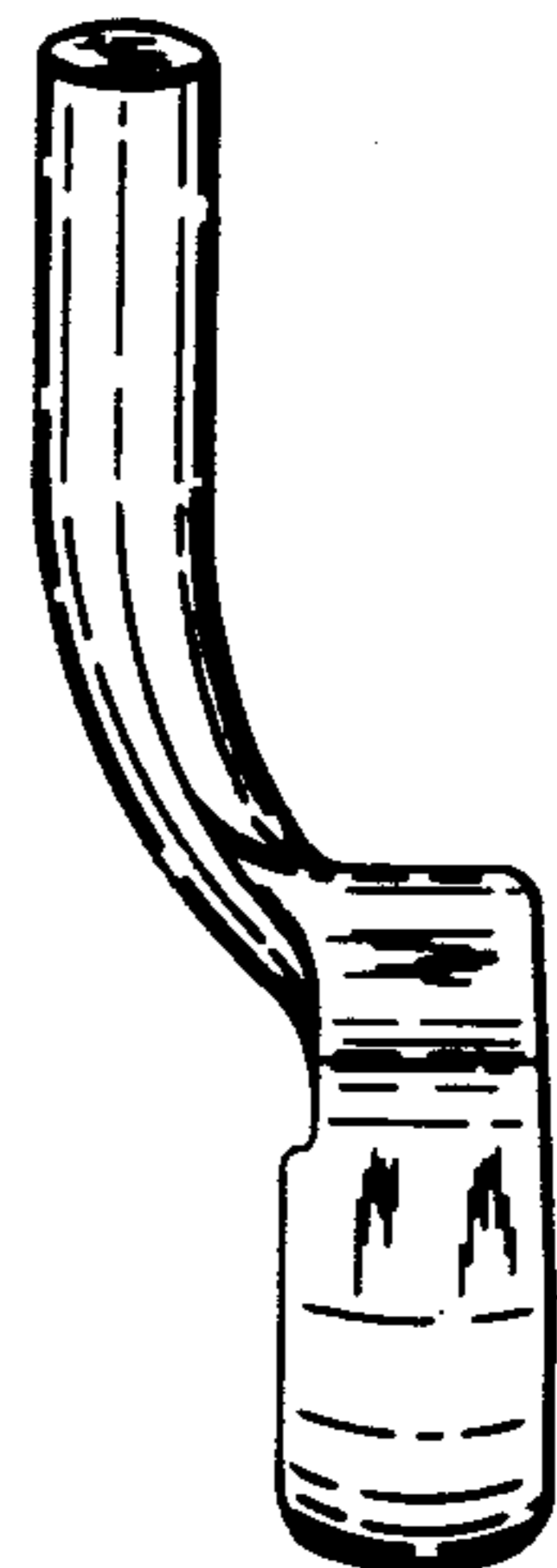

FIG. 3.

FIG. 6.

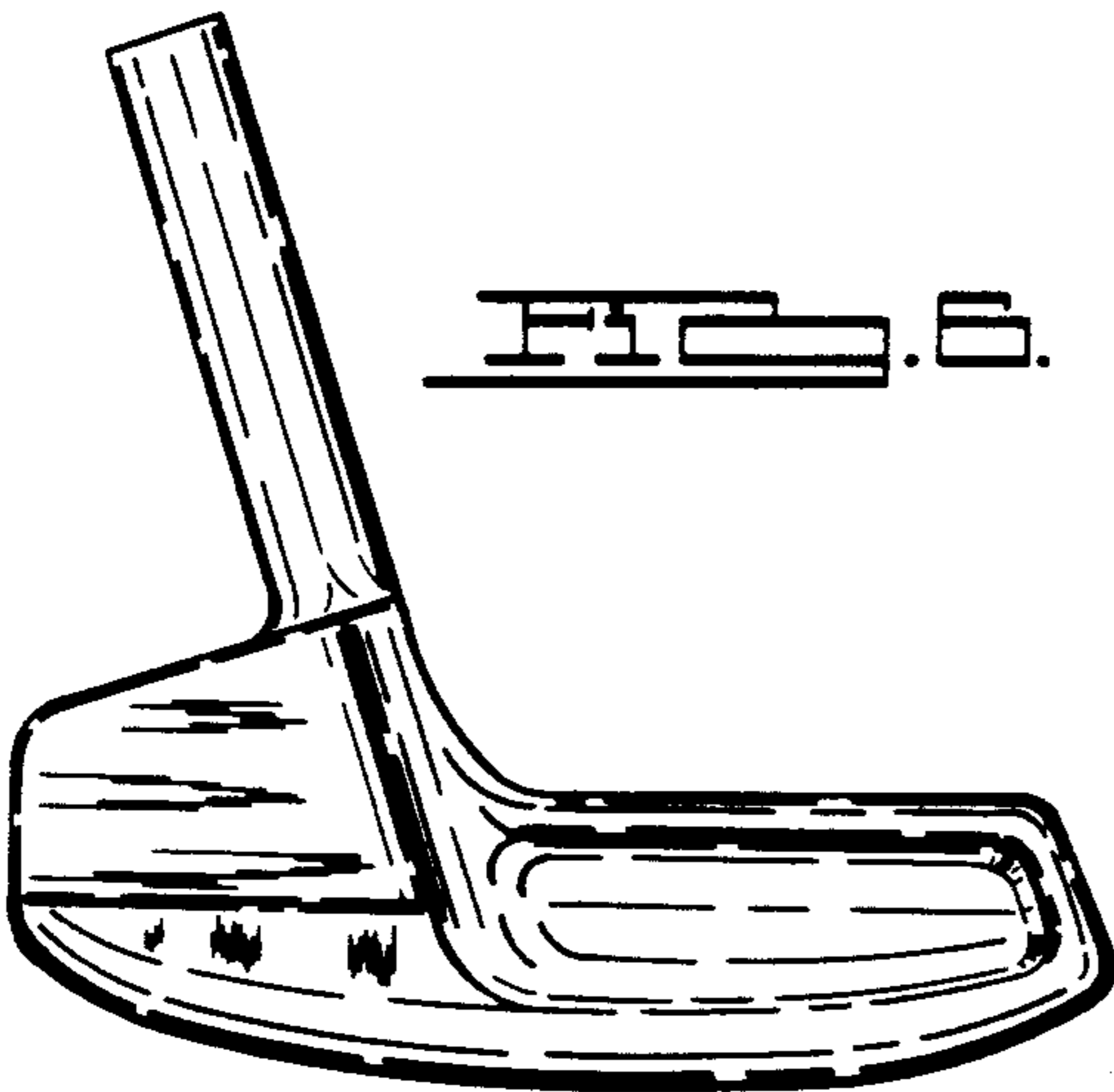

FIG. 7.



FIG. 8.



FIG. 9.