

[54] ROOM DEODORANT DISPENSER

[75] Inventors: **Richard C. Palson**, Medfield; **John C. Armstrong**, Milton, both of Mass.

[73] Assignee: **The Pharmasol Corporation**, Mass.

[**] Term: **14 Years**

[21] Appl. No.: **970,612**

[22] Filed: **Dec. 18, 1978**

[51] Int. Cl. **D23-04**

[52] U.S. Cl. **D23/150**

[58] Field of Search **D23/145-150;**
239/44-60

[56] **References Cited**

U.S. PATENT DOCUMENTS

D. 136,877	12/1943	Estes	D23/150
D. 196,579	10/1963	Kagan	D23/150
D. 196,907	11/1963	Halvorson	D23/150
D. 216,974	3/1970	Wilson	D23/150
D. 226,433	3/1973	Hill	D23/150

D. 236,122	7/1975	Numbers	D23/150
1,972,368	9/1934	Alex	239/55 X
2,228,505	1/1941	Carter et al.	D23/150 X
2,234,021	3/1941	Castrique	239/57 X
2,942,786	6/1960	Wenner et al.	239/57 X

Primary Examiner—James R. Largen
Attorney, Agent, or Firm—Robert E. Meyer

[57] **CLAIM**

The ornamental design for a room deodorant dispenser, as shown.

DESCRIPTION

FIG. 1 is a front isometric view of a room deodorant dispenser showing our new design;
FIG. 2 is another front isometric view thereof, showing the louvers in an open position;
FIG. 3 is a front elevational view thereof;
FIG. 4 is a top plan view thereof;
FIG. 5 is an end elevational view thereof;
FIG. 6 is a rear elevational view thereof; and
FIG. 7 is a cross sectional view taken on line 7-7 of FIG. 3.

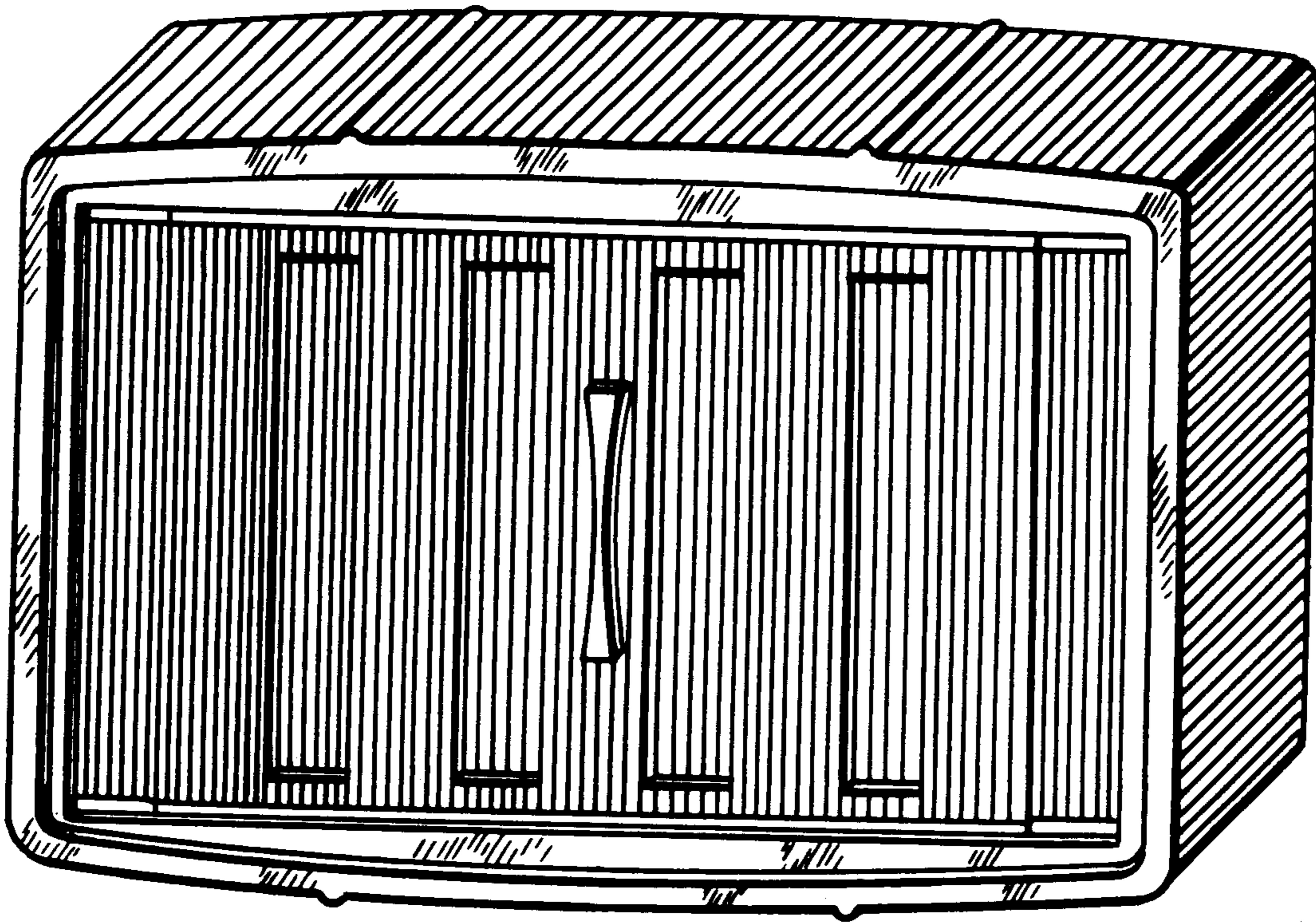

FIG.1

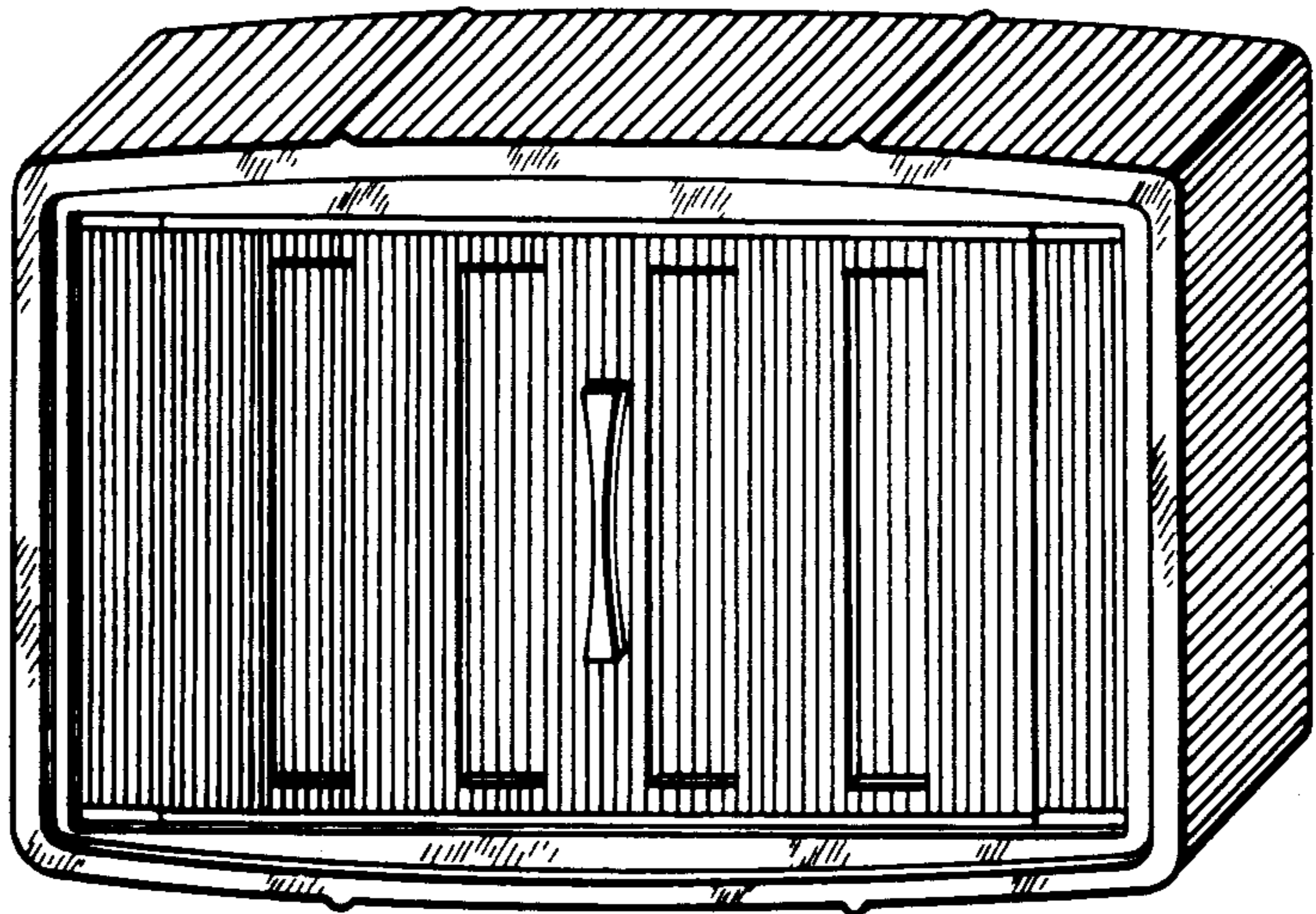

FIG.2

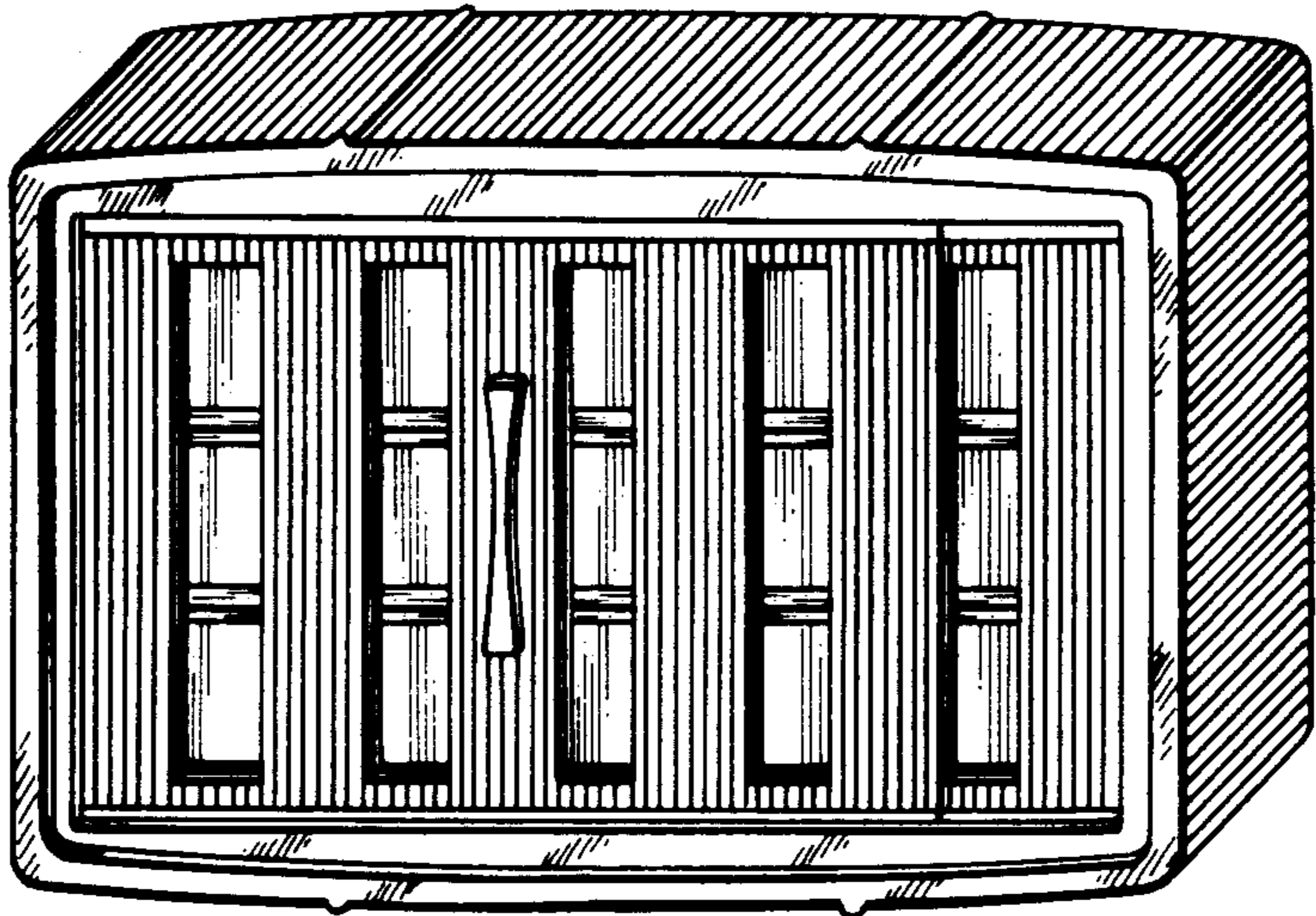
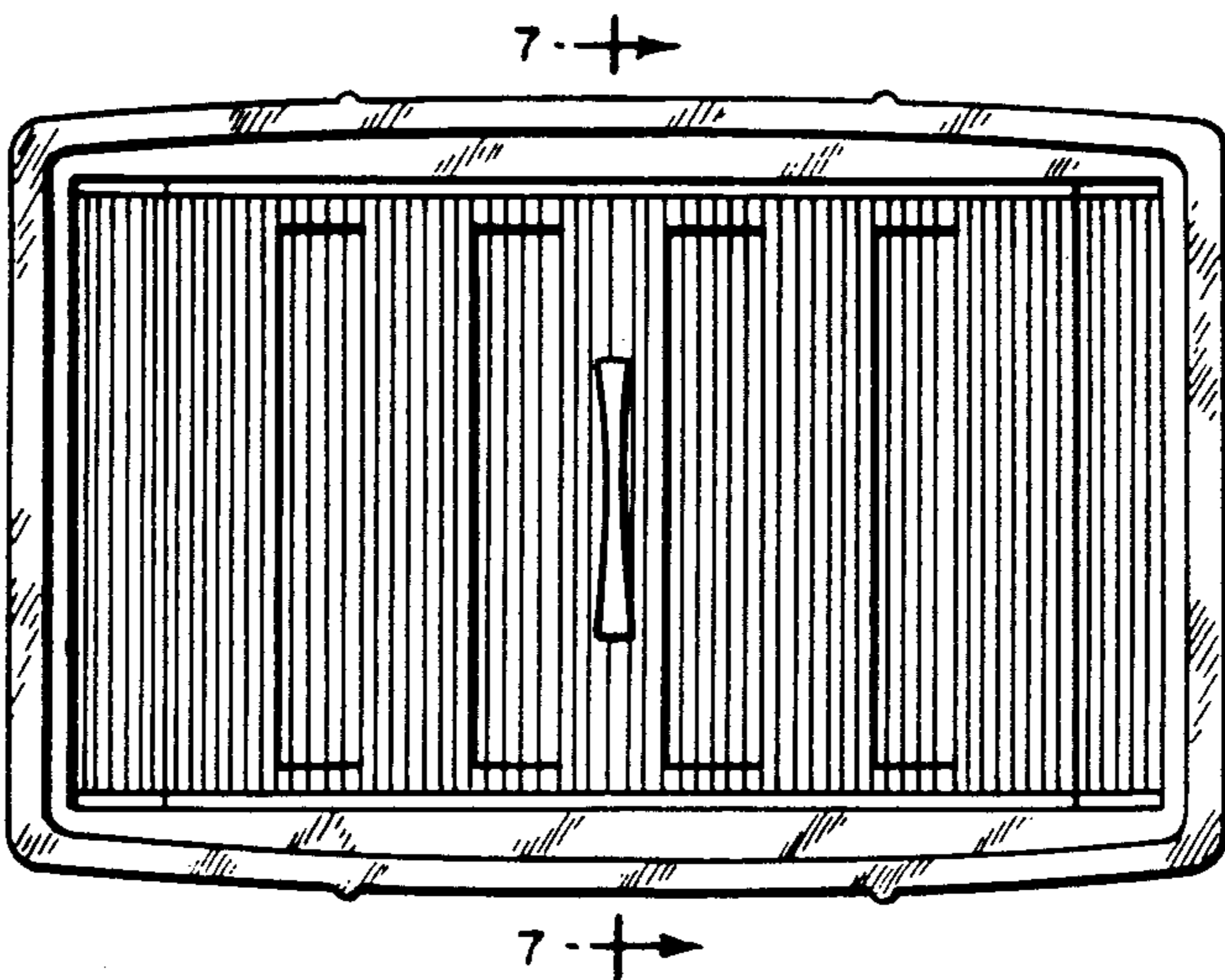

FIG.3



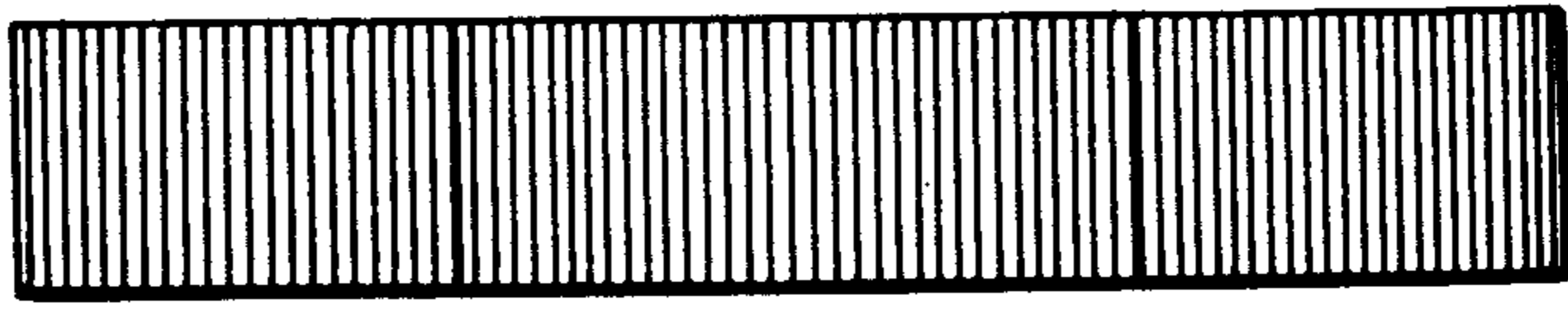

FIG. 4



FIG. 5

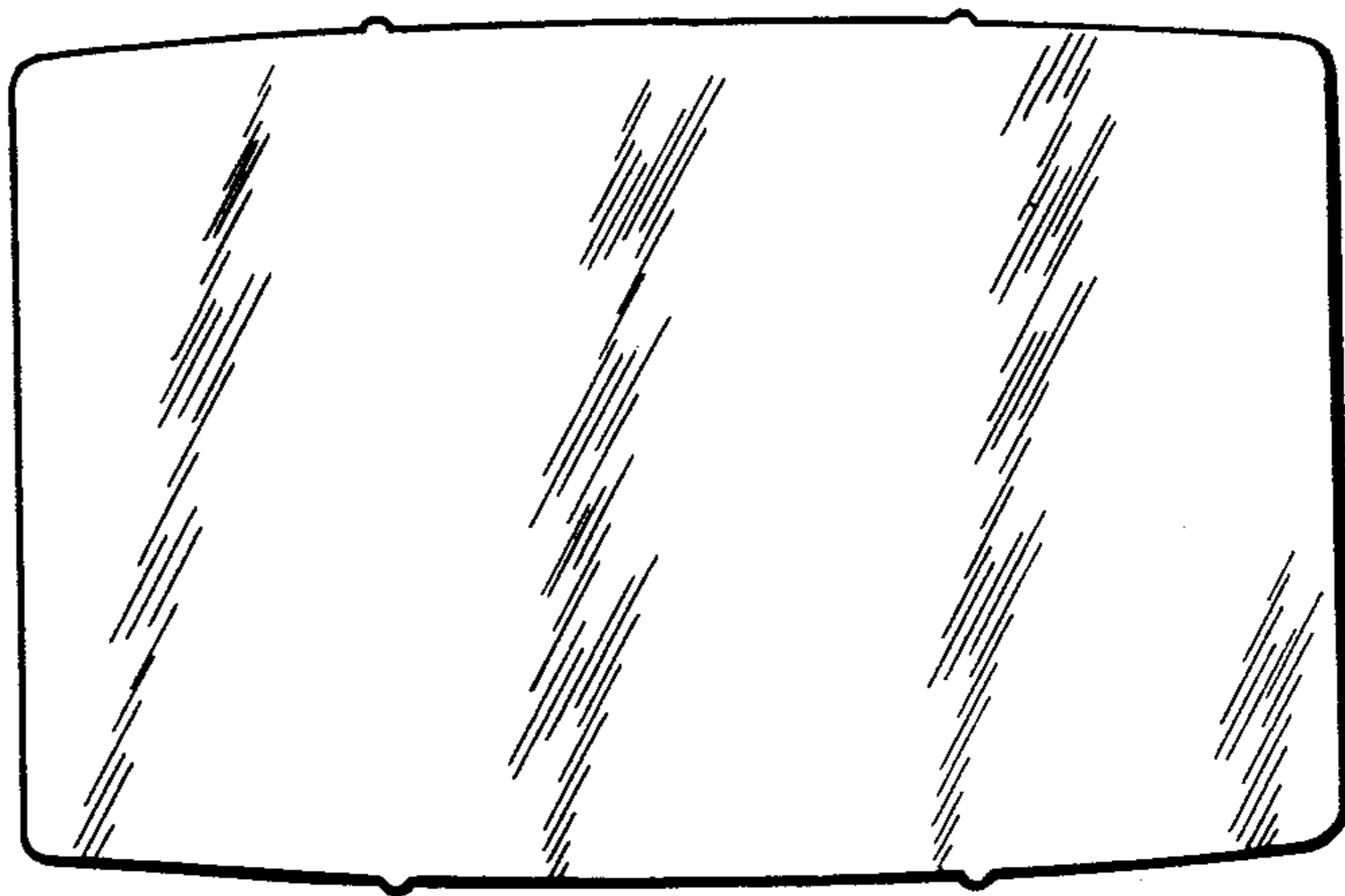

FIG. 6

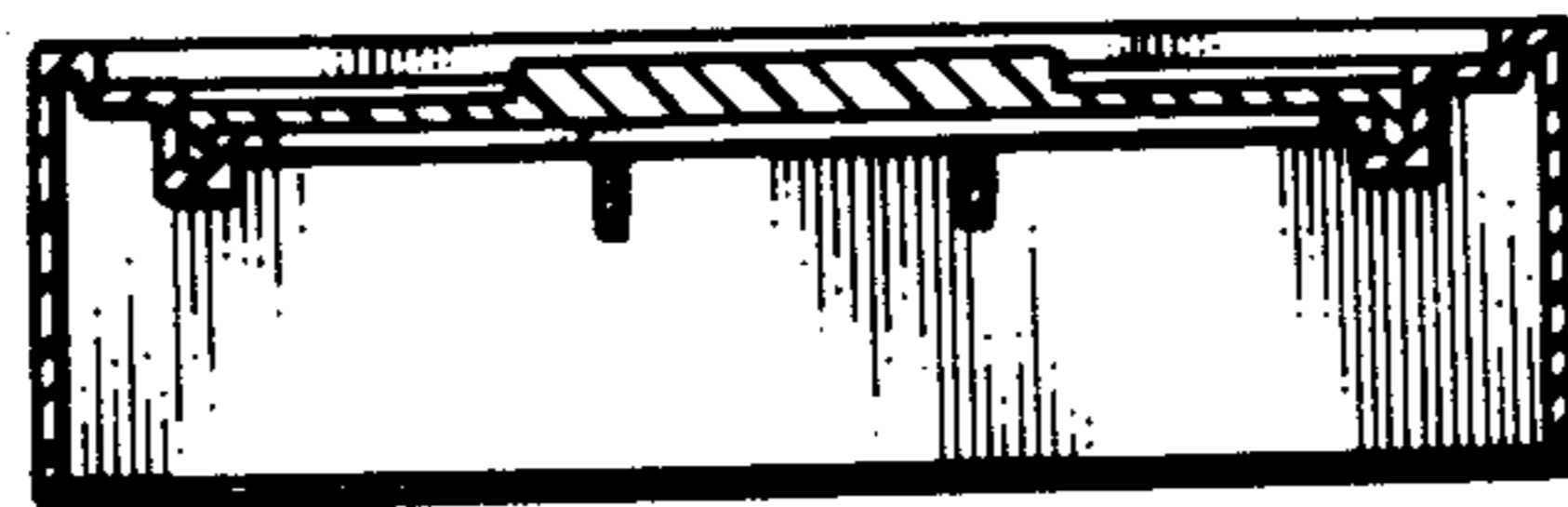

FIG. 7