

[54] COMBINED TOY VEHICLE AND STACKED, REMOVABLE ARTICLES

[75] Inventors: Shinroku Nakao, Yokohama; Yoshiyasu Ishii; Kazuo Nagata, both of Tokyo, all of Japan

[73] Assignee: Combi Co., Ltd., Tokyo, Japan

[\*\*] Term: 14 Years

[21] Appl. No.: 795,592

[22] Filed: May 10, 1977

[51] Int. Cl. .... D21-01

[52] U.S. Cl. .... D21/137

[58] Field of Search ..... D34/15 AJ, 15 AN; 46/97, 111, 201, 202, 206, 210, 214

[56] References Cited

U.S. PATENT DOCUMENTS

- D. 219,930 2/1971 Fogarty et al. .... D34/15 AJ
- D. 230,412 2/1974 Salmon et al. .... D34/15 AN
- D. 230,413 2/1974 Salmon et al. .... D34/15 AN

OTHER PUBLICATIONS

Sears Christmas Catalog 1973, p. 487, item #4, Toy Jeep.

Primary Examiner—Joel Stearman

Assistant Examiner—Charles A. Rademaker

Attorney, Agent, or Firm—Richard C. Sughrue

[57] CLAIM

The ornamental design for a combined toy vehicle and stacked, removable articles, as shown.

DESCRIPTION

FIG. 1 is a front, top and right side perspective view of a combined toy vehicle and stacked, removable articles showing our new design;

FIG. 2 is a rear, top and left side perspective view;

FIG. 3 is a front perspective view thereof;

FIG. 4 is a rear perspective view thereof;

FIG. 5 is a right side perspective view thereof;

FIG. 6 is a top perspective view thereof; and,

FIG. 7 is a bottom perspective view thereof.

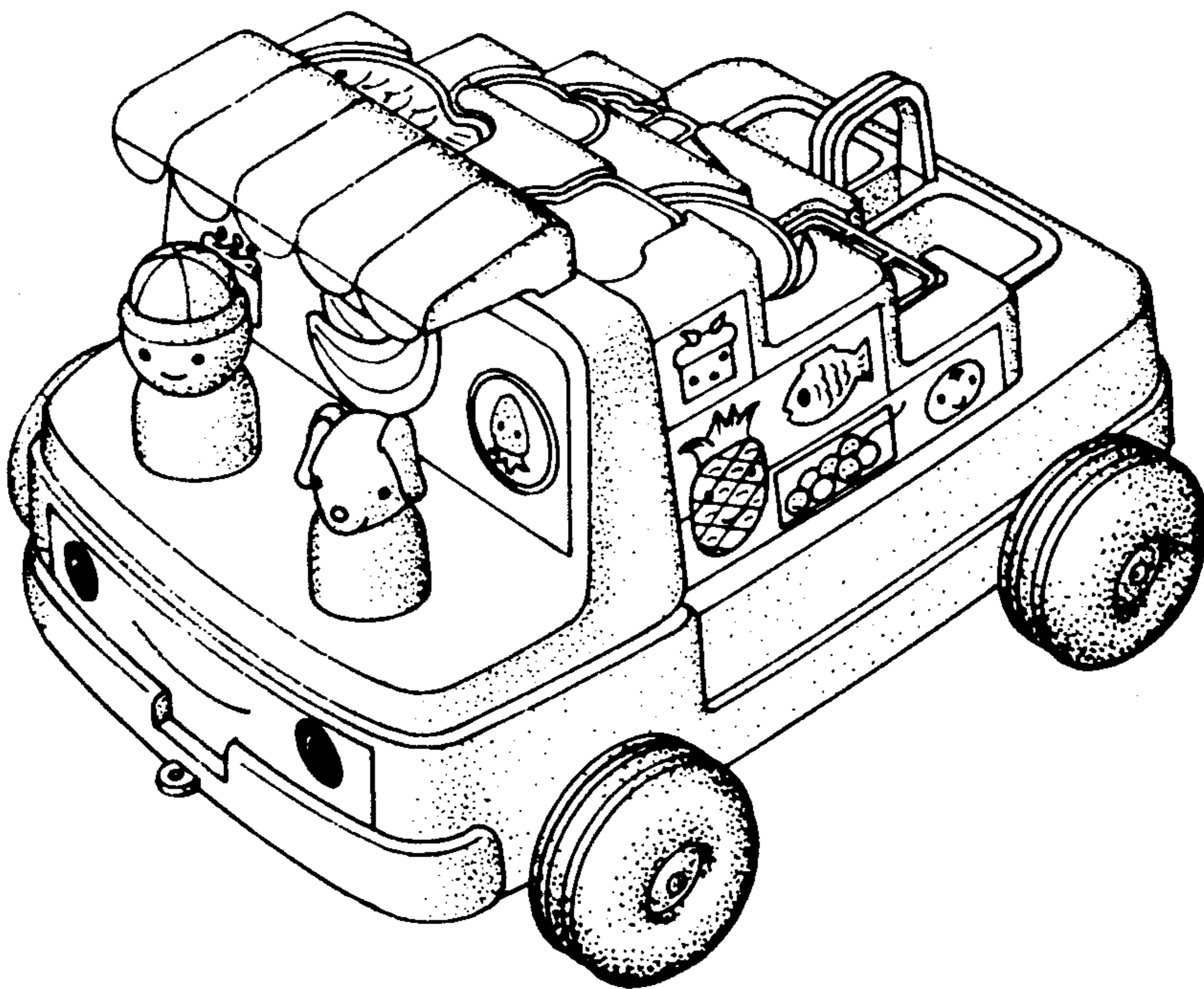

*FIG. 1*

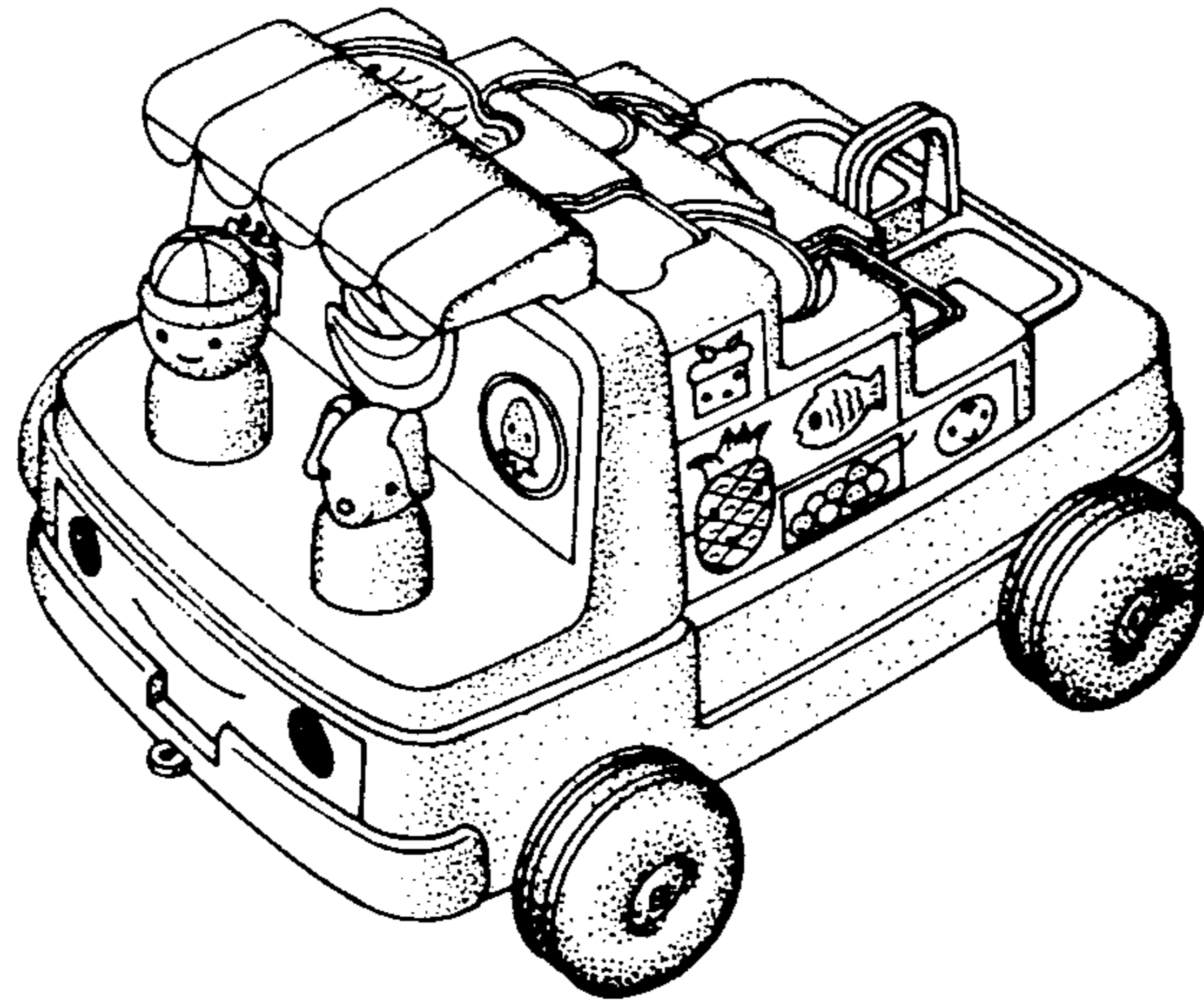

*FIG. 2*

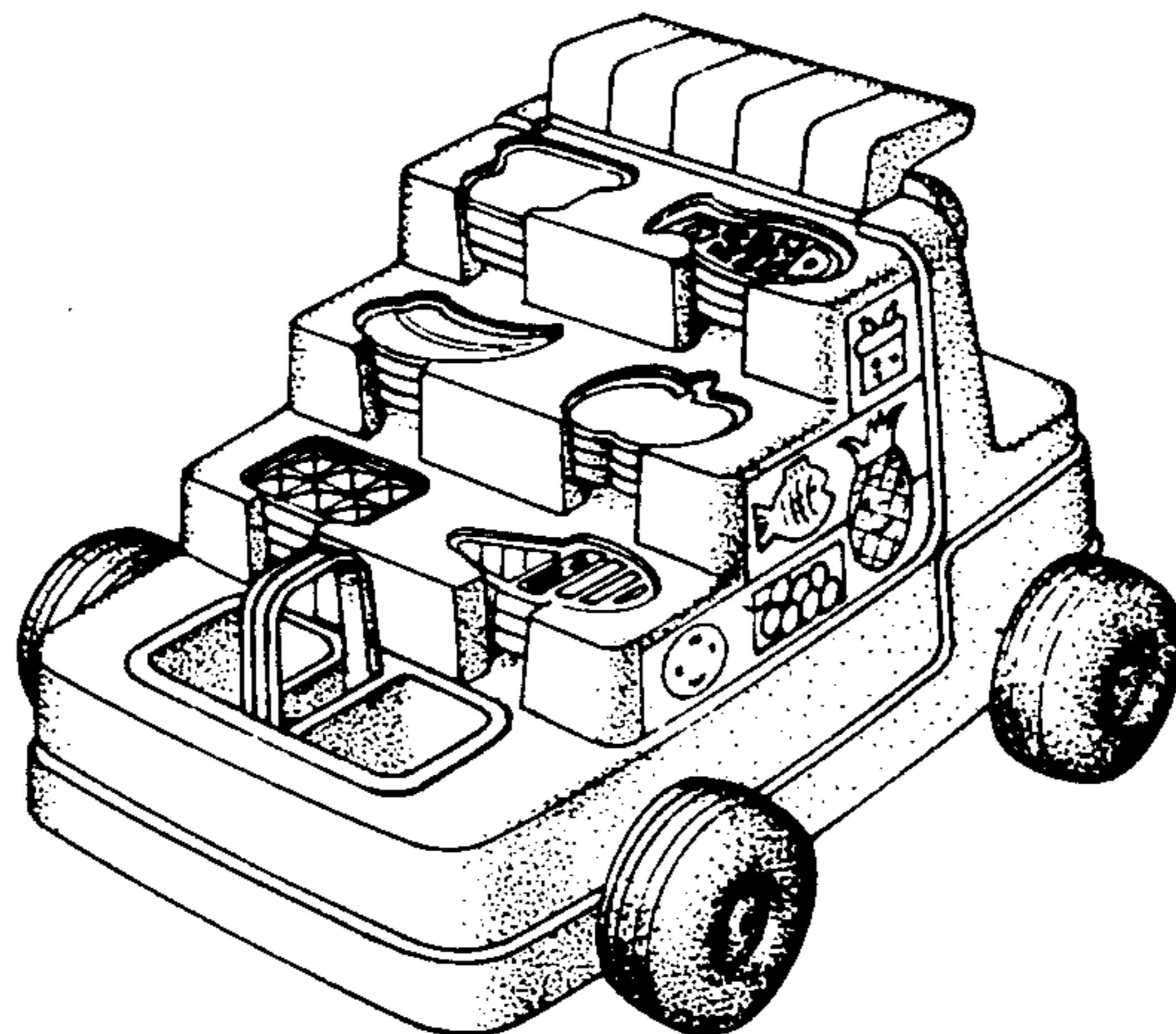

FIG. 3

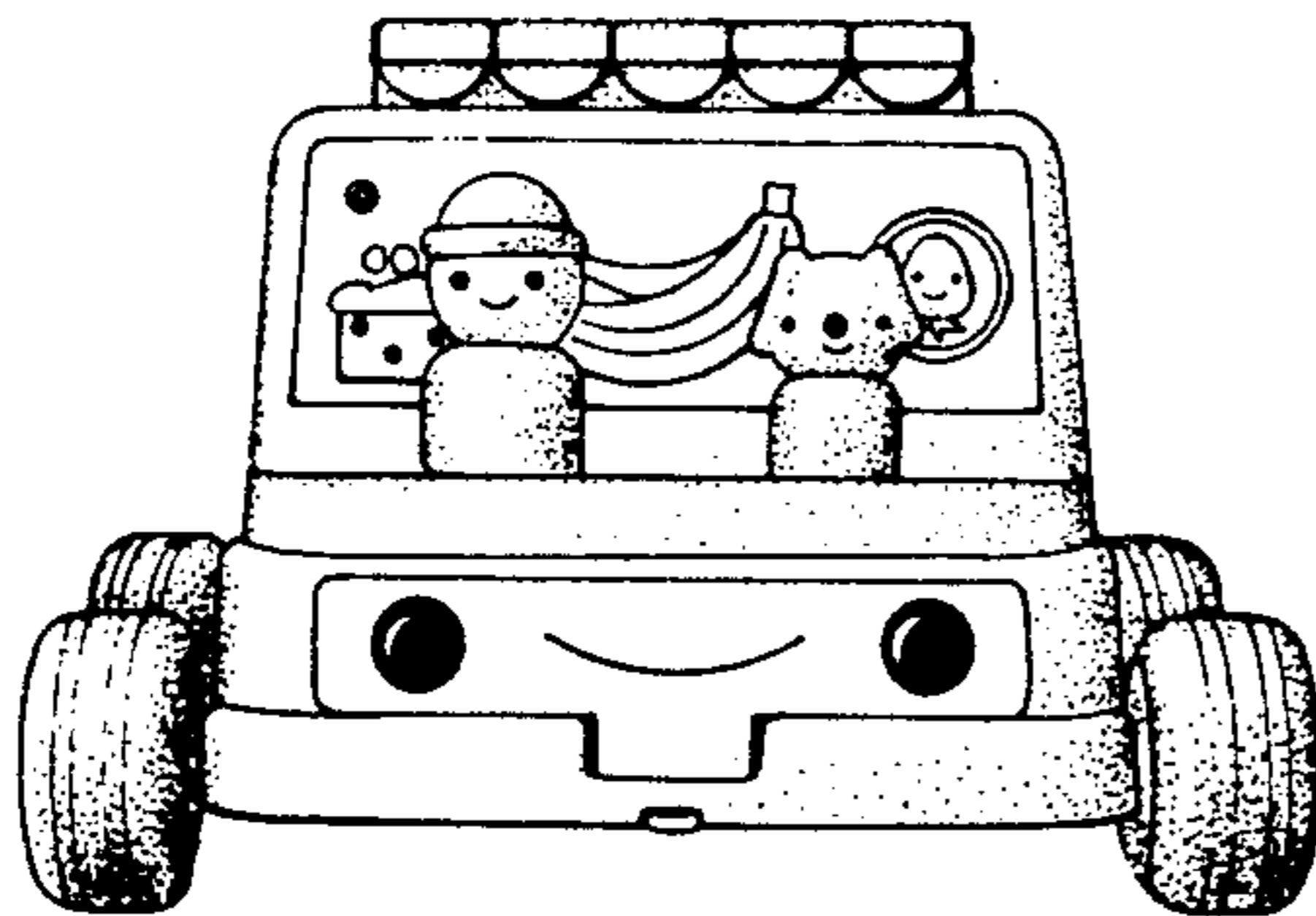

FIG. 4

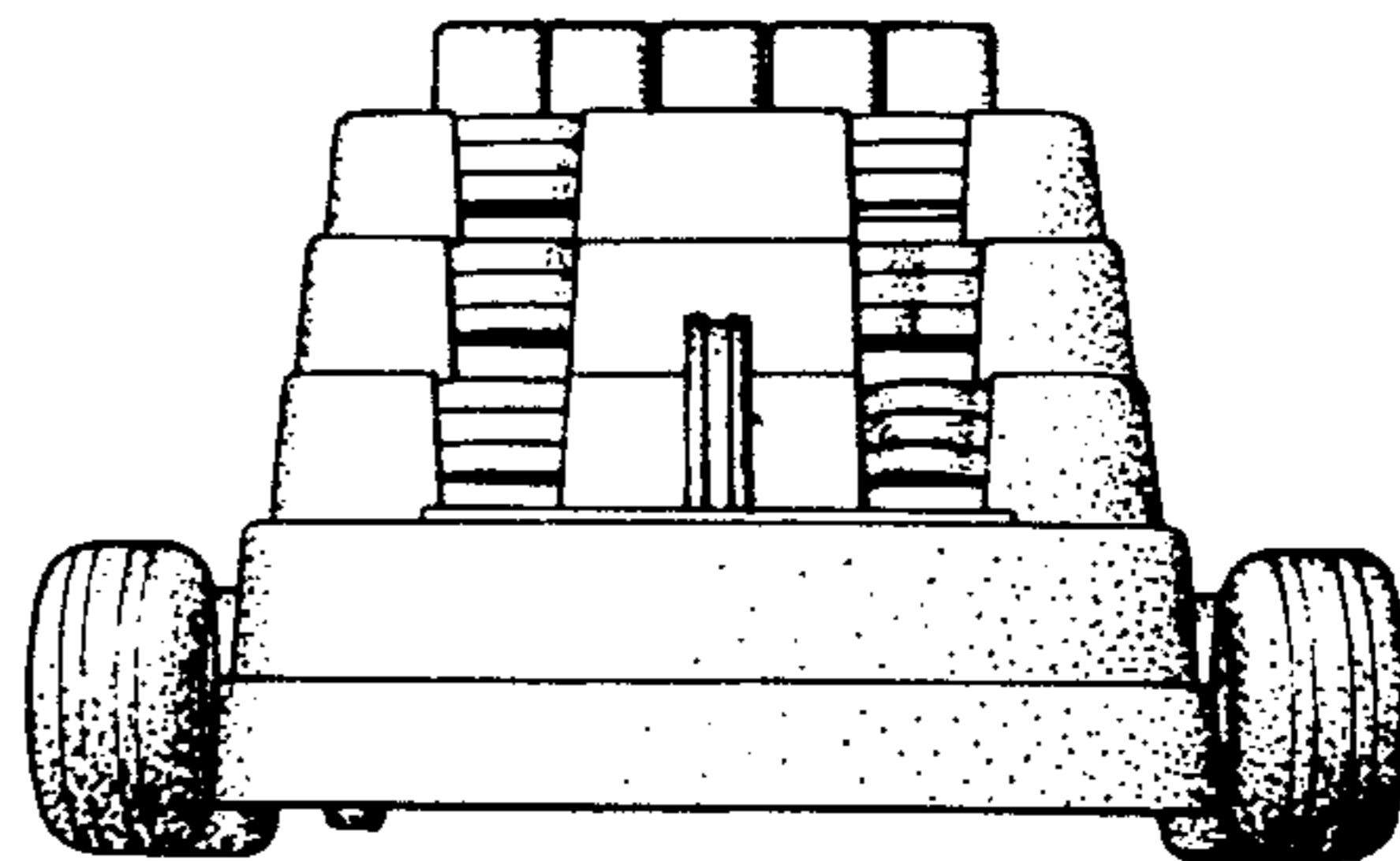

FIG. 5

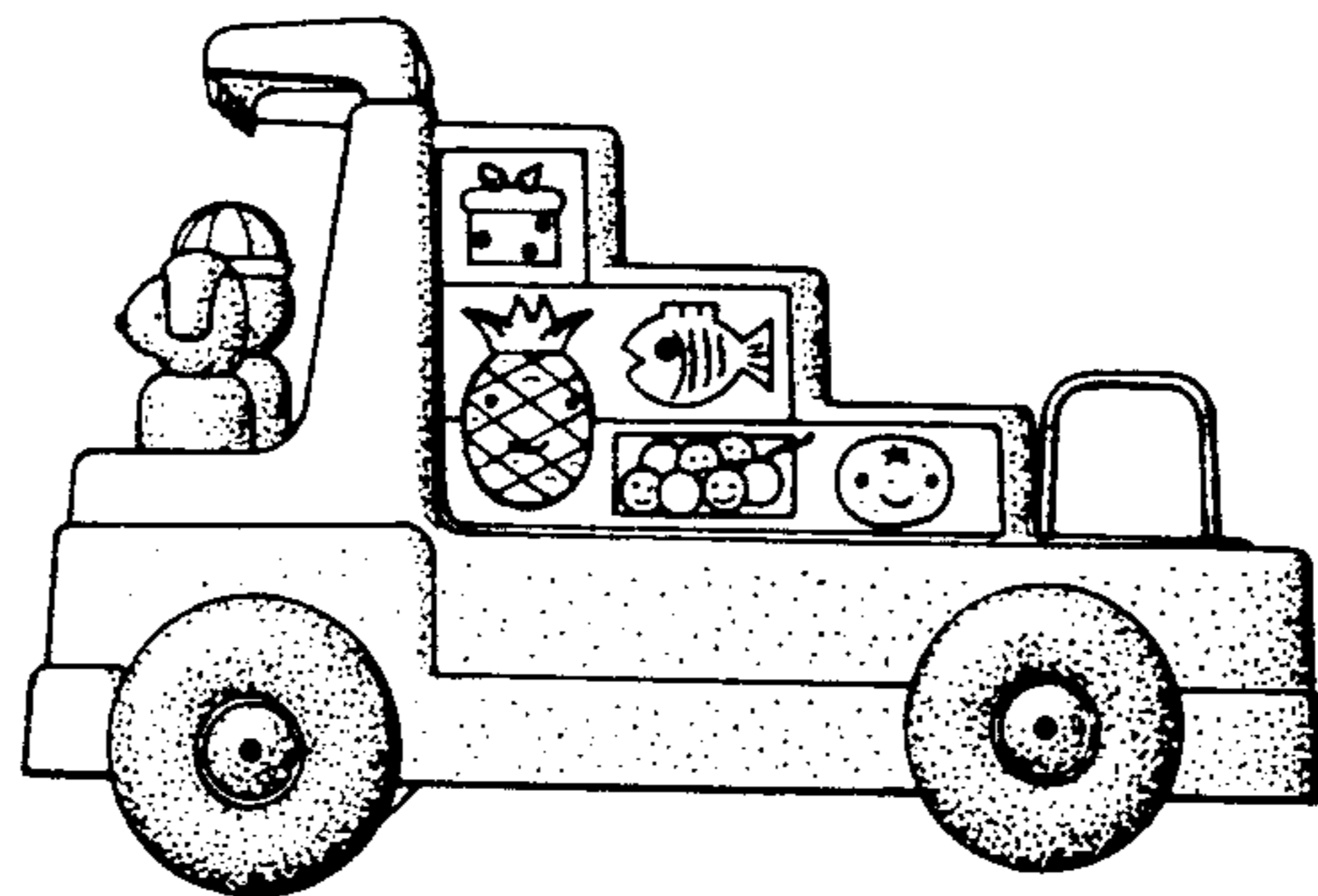

FIG. 6

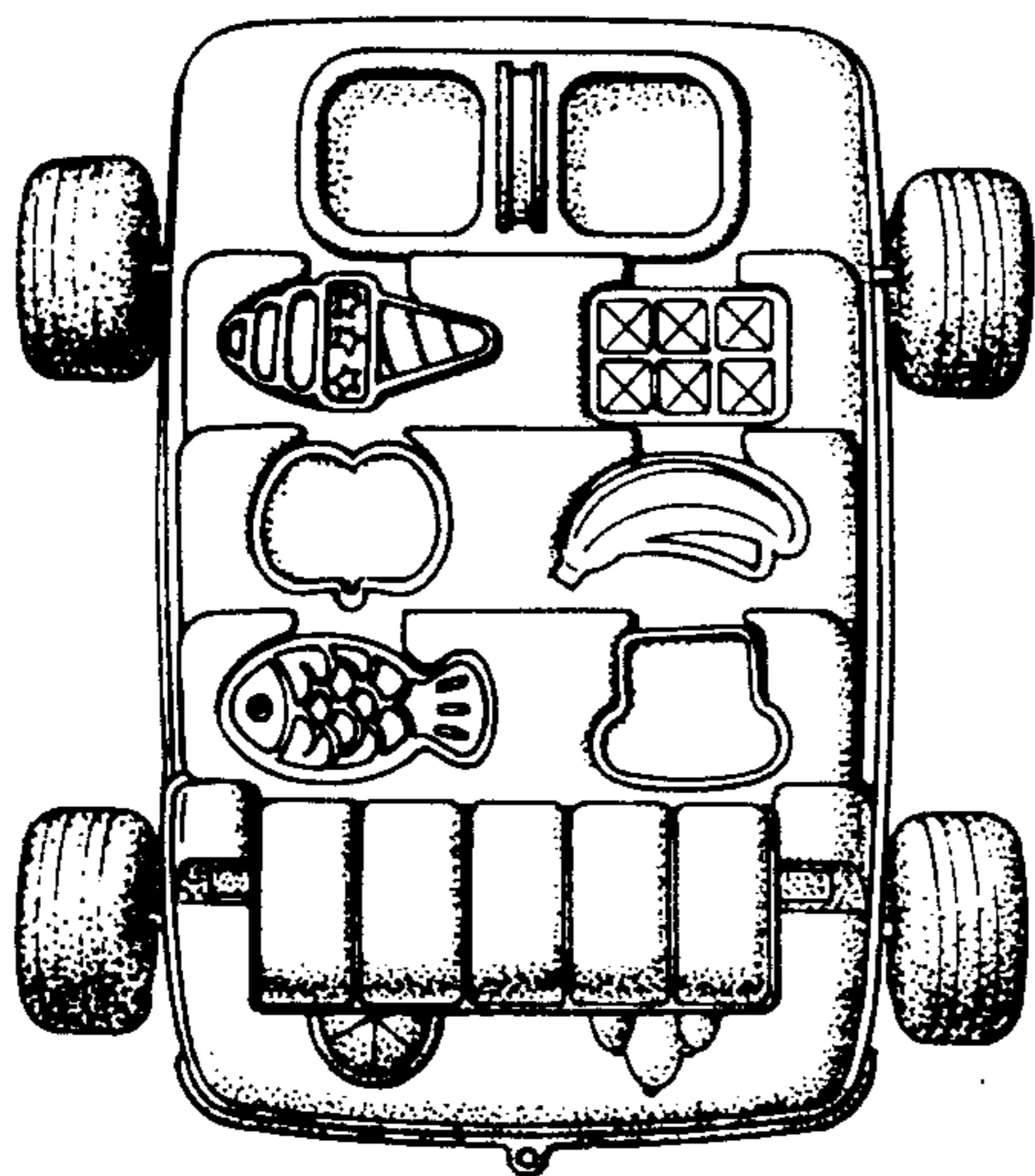

FIG. 7

