

[54] TYPEWRITER

[75] Inventor: James J. Beinkowski, Cazenovia, N.Y.

[73] Assignee: SCM Corporation, New York, N.Y.

[\*\*] Term: 14 Years

[21] Appl. No.: 889,992

[22] Filed: Mar. 24, 1978

[51] Int. Cl. .... D18-01

[52] U.S. Cl. .... D18/1

[58] Field of Search ..... D14/45; D18/1, 7, 8, D18/12, 99; 400/691-694

[56]

References Cited

U.S. PATENT DOCUMENTS

|            |         |                |         |
|------------|---------|----------------|---------|
| D. 193,917 | 10/1962 | Sundberg ..... | D18/1   |
| D. 216,840 | 3/1970  | Joseph .....   | D18/7   |
| D. 230,088 | 1/1974  | Bellini .....  | D18/1   |
| D. 237,109 | 10/1975 | Genaro .....   | D18/1 X |

Primary Examiner—Louis S. Zarfaz  
Attorney, Agent, or Firm—William E. Mear, III

[57]

CLAIM

The ornamental design for a typewriter, as shown.

DESCRIPTION

FIG. 1 is a front perspective view of a typewriter showing my new design;  
FIG. 2 is a top plan view thereof;  
FIG. 3 is a front elevational view thereof;  
FIG. 4 is a rear elevational view thereof;  
FIG. 5 is a bottom plan view thereof;  
FIG. 6 is a left side elevational view thereof; and  
FIG. 7 is a right side elevational view thereof.

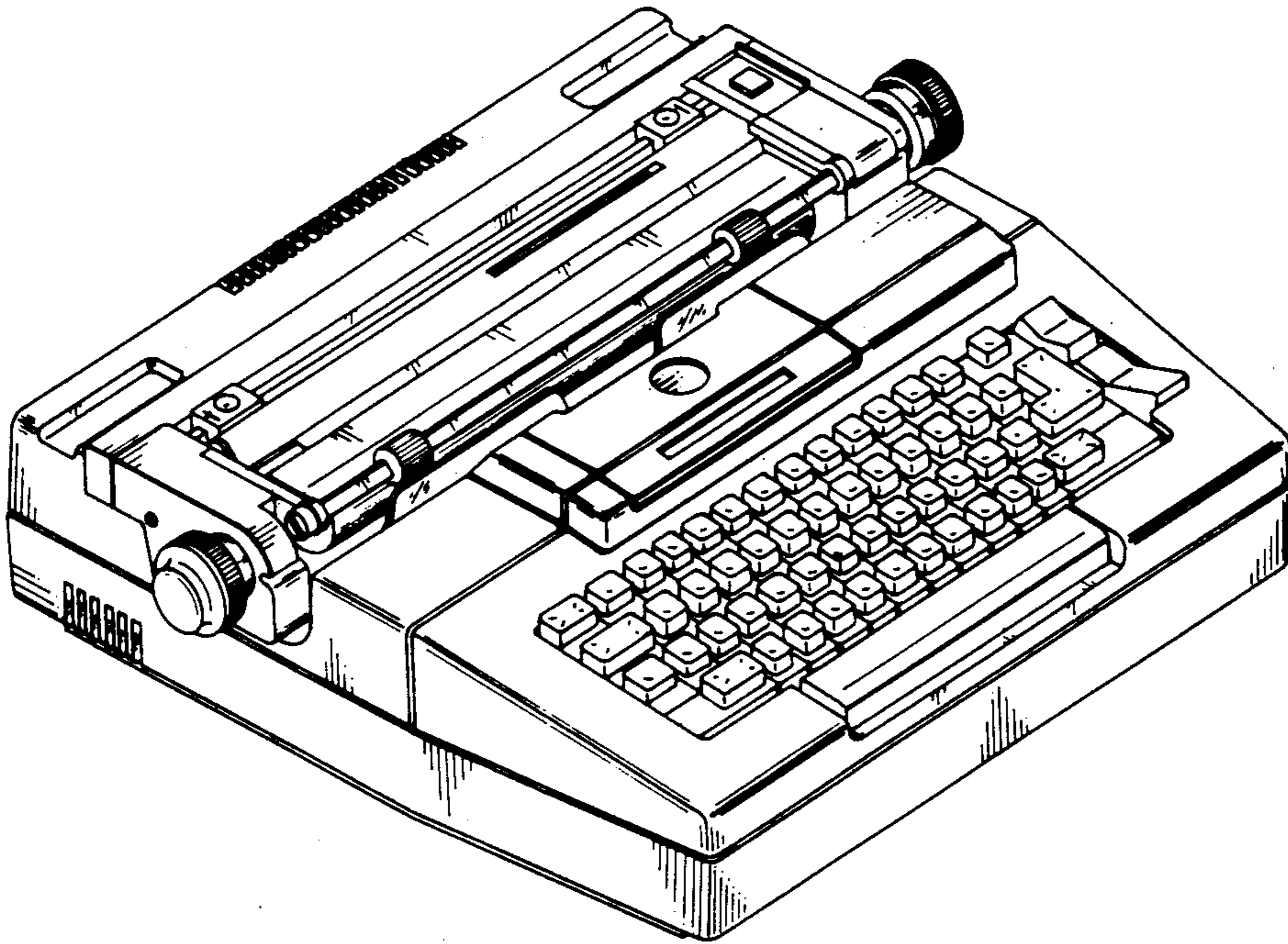

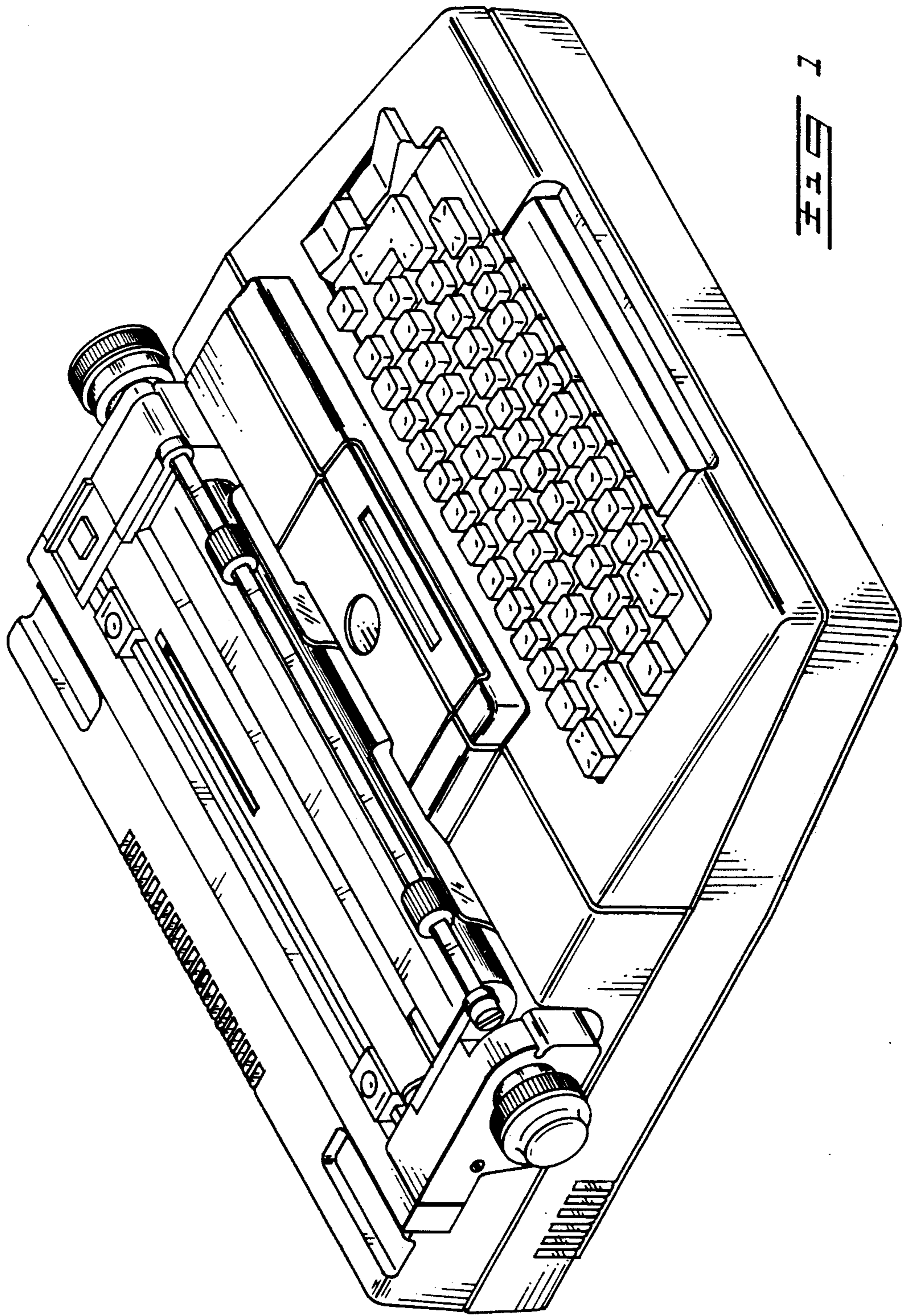

Fig. 1

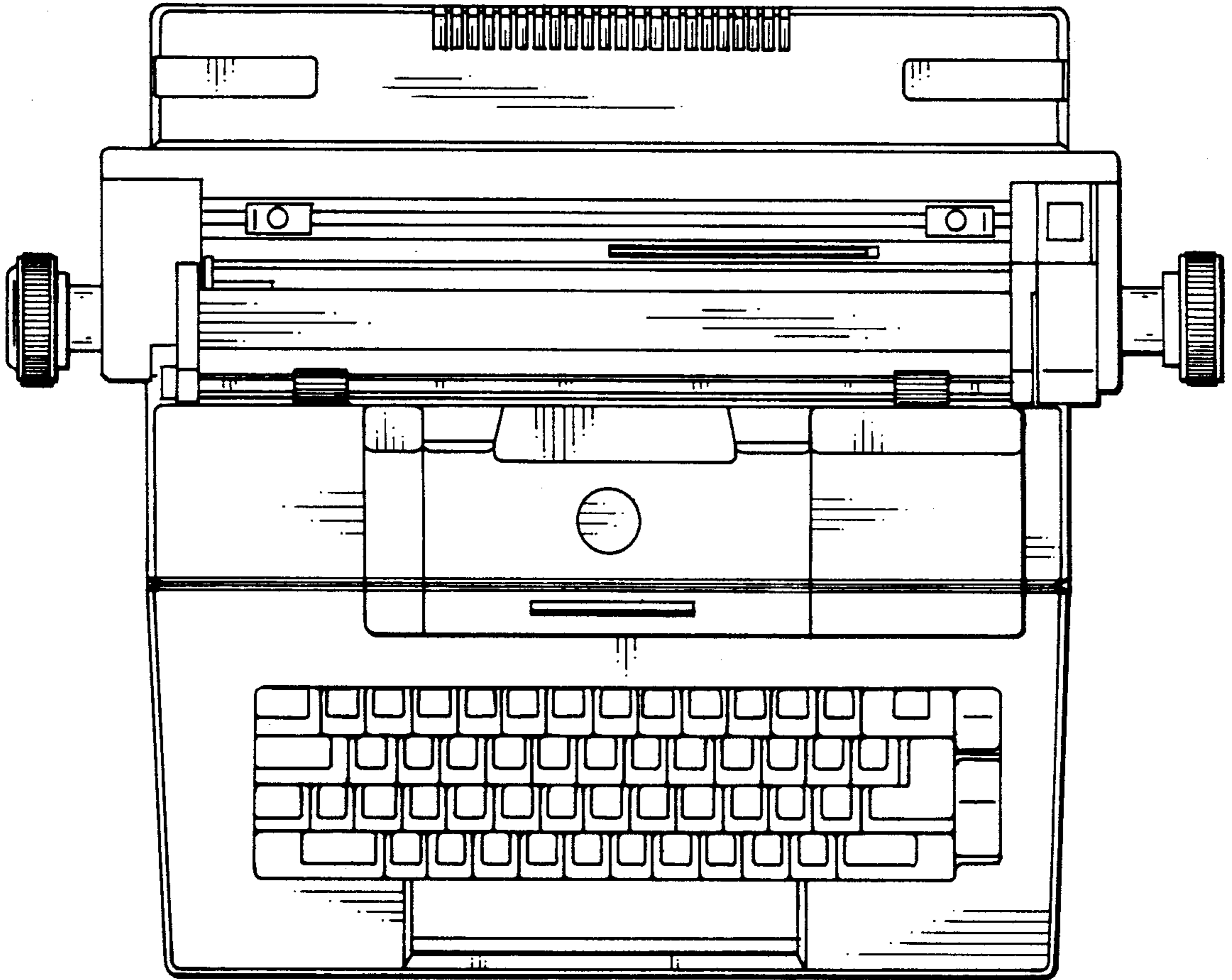

FIG 2

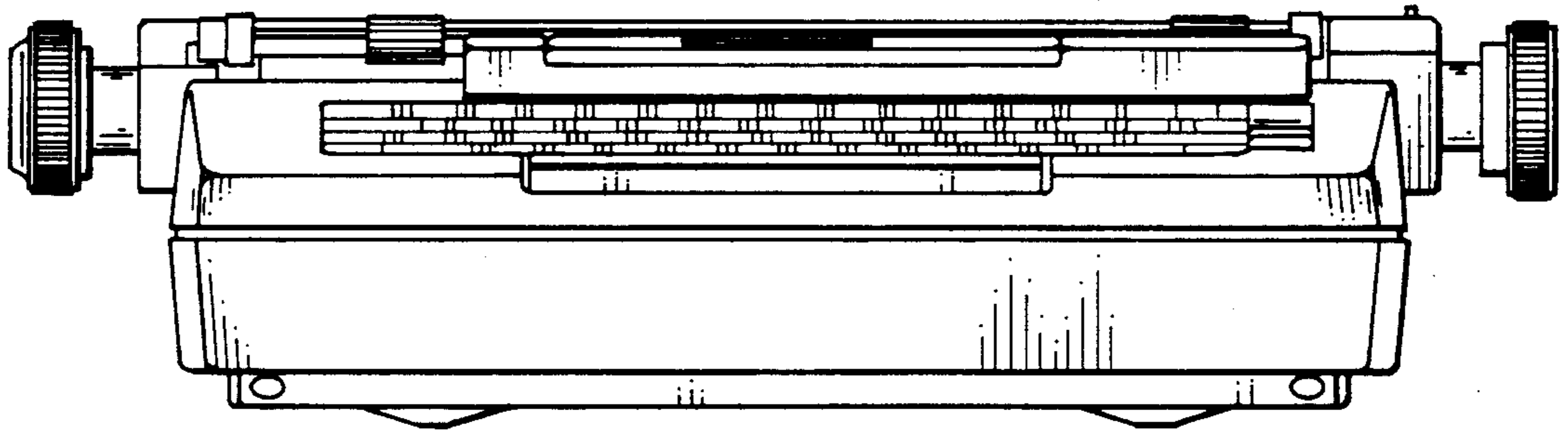

FIG 3

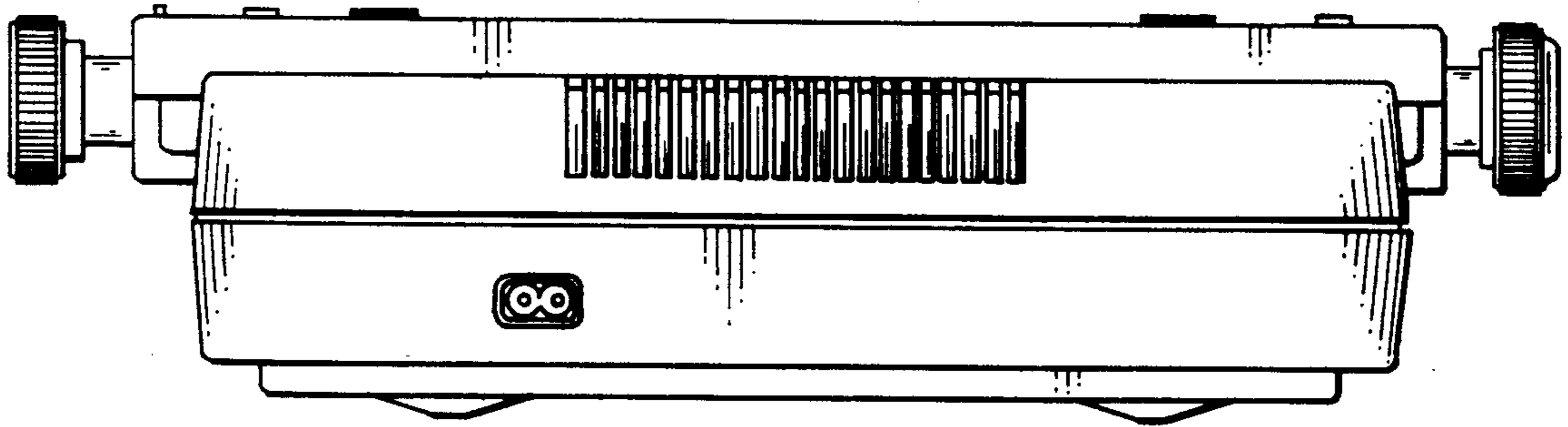

Fig 4

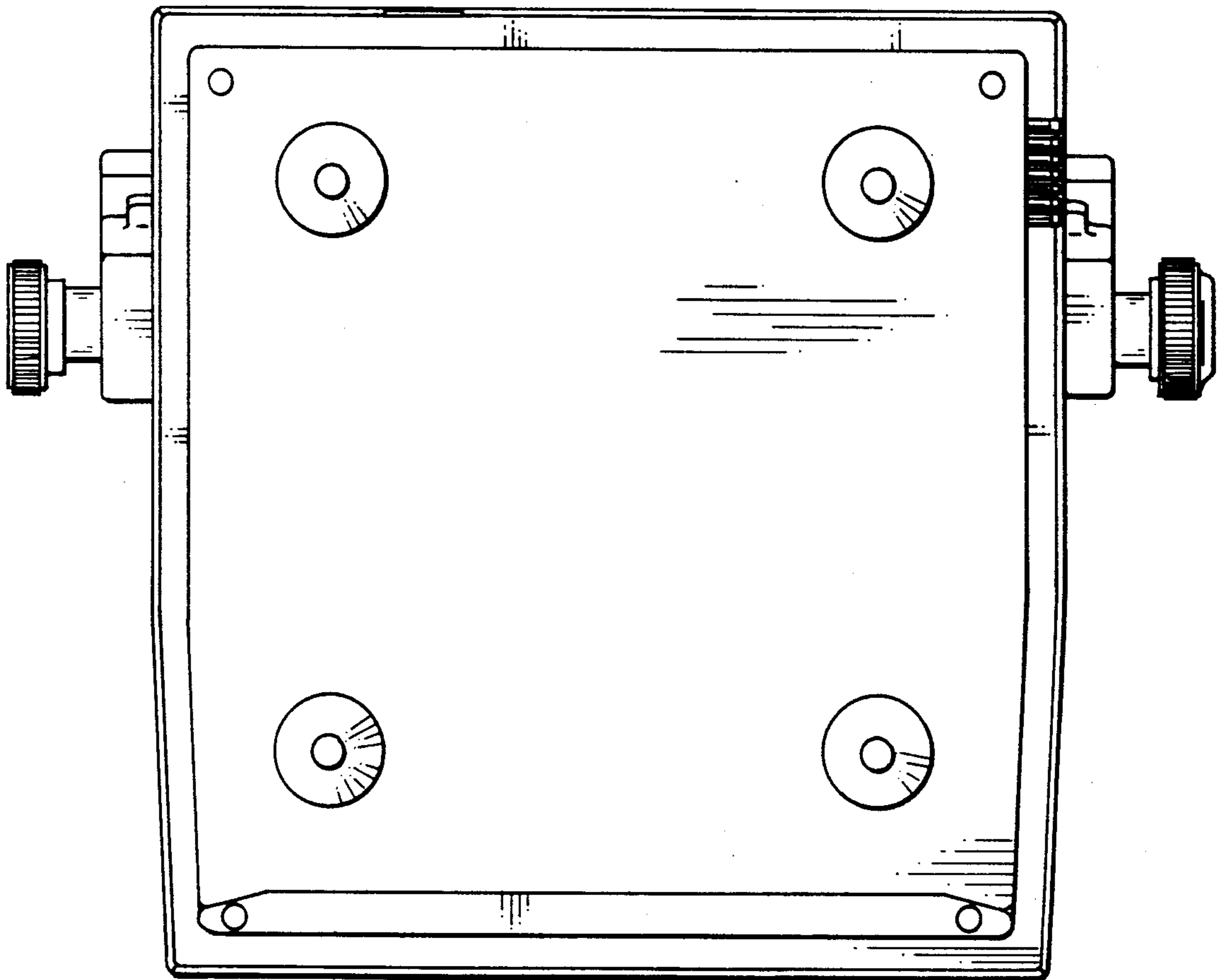

Fig 5

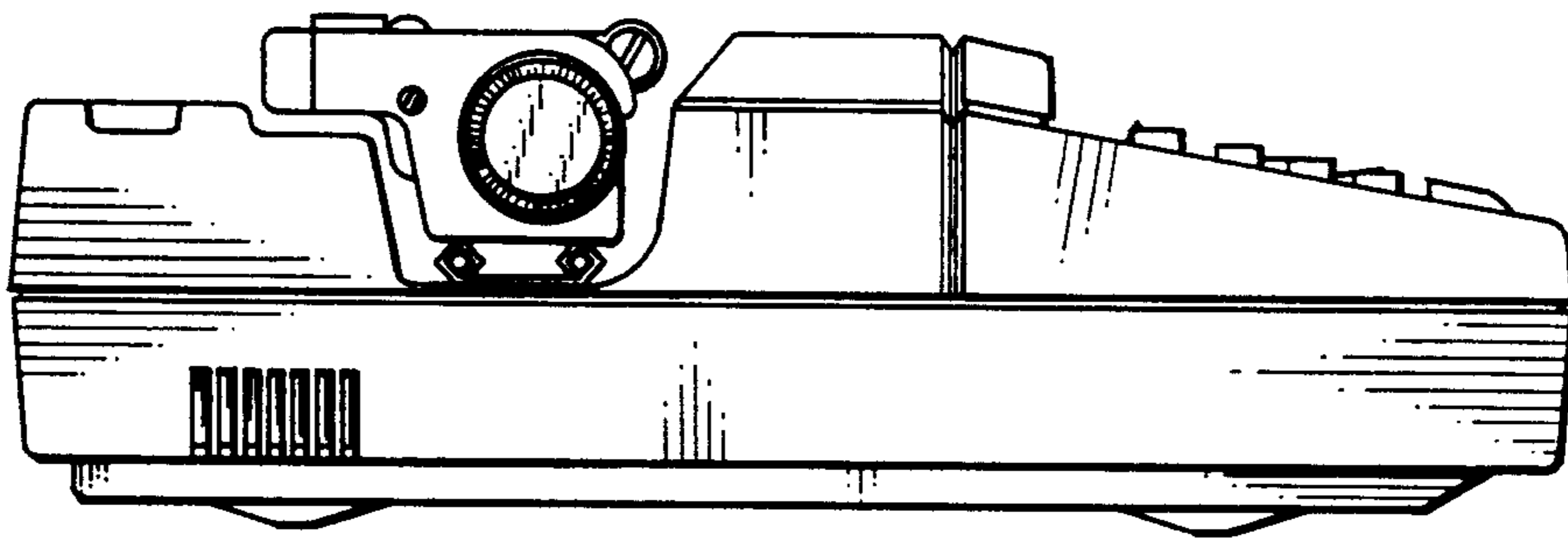

Fig. 6

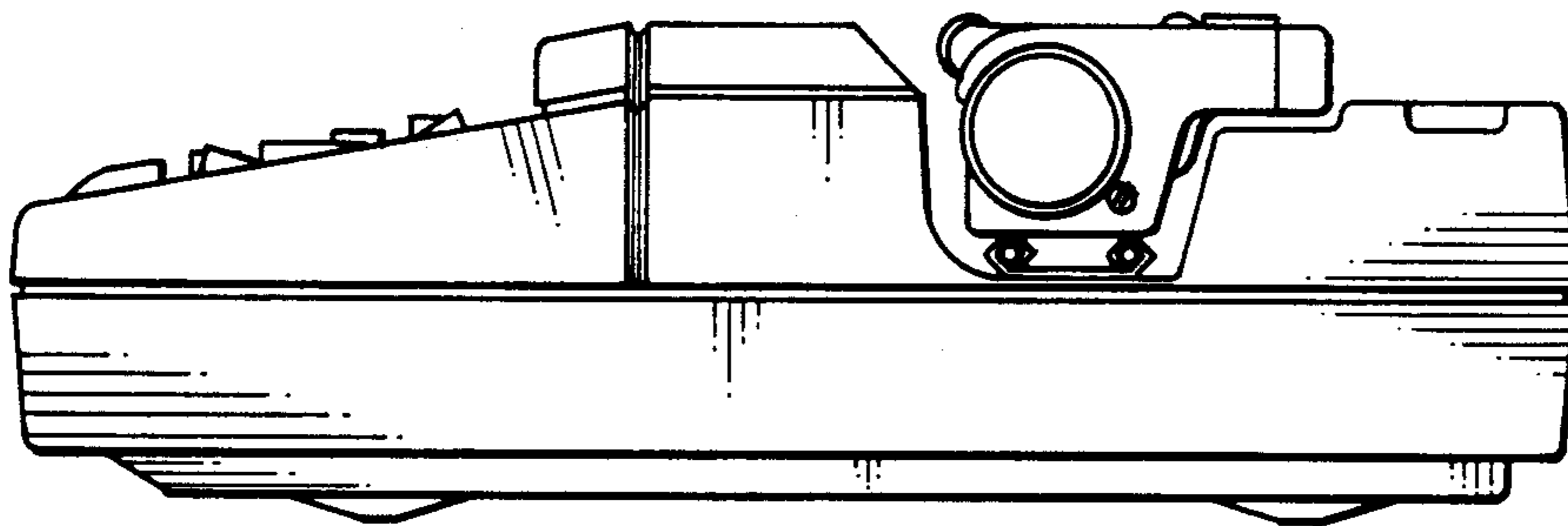

Fig. 7